

Dell™ PowerConnect™ 3324/3348 User's Guide

[Overview](#)

[Hardware Description](#)

[Installing the PowerConnect 3324/3348 Switch](#)

[Configuring the PowerConnect 3324/3348 Switch](#)

[Getting Started](#)

[Configuring System Information](#)

[Configuring Switch Information](#)

[Viewing Statistics](#)

[Configuring Quality of Service](#)

[Getting Help](#)



NOTE: Notes indicate important information that helps you make better use of your device.



NOTICE: Notices indicate either potential damage to hardware or loss of data and tells you how to avoid the problem.



CAUTION: Caution indicates a potential for property damage, personal injury, or death.

Information in this document is subject to change without notice.
© 2003 Dell Inc. All rights reserved.

Reproduction in any manner whatsoever without the written permission of Dell Inc. is strictly forbidden.

Trademarks used in this text: *Dell*, the *DELL* logo, *PowerConnect*, *Dell OpenManage*, *PowerEdge*, *Inspiron*, *Dell Precision*, *Dimension*, *OptiPlex*, *Axim*, *PowerVault*, *PowerApp*, *DellNet*, and *Latitude* are trademarks of Dell Inc.; *Microsoft* and *Windows* are registered trademarks of Microsoft Corporation.

Other trademarks and trade names may be used in this document to refer to either the entities claiming the marks and names or their products. Dell Inc. disclaims any proprietary interest in trademarks and trade names other than its own.

November 2003

Configuring the PowerConnect 3324/3348 Switch

Dell™ PowerConnect™ 3324/3348 User's Guide

- [Configuration Overview](#)
- [General Configuration Information](#)
- [Terminal Connection Configuration](#)
- [Other Configuration Requirements](#)
- [Booting the Device](#)
- [Device Configuration Introduction](#)
- [Initial Configuration](#)
- [Advanced Configuration](#)
- [Sample Configuration Process](#)
- [Configuring Stacking](#)
- [Rebooting the Device](#)
- [Startup Menu Functions](#)
- [Downloading the Software to Stacking Units](#)
- [Defining SNMP Settings](#)
- [Connecting Devices](#)

Configuration Overview

This section describes the initial device configuration and includes:

- 1 Initial Device Bootup
- 1 Preliminary Configuration Requirements
- 1 Configuring Stacking

After all the device external connections are in place, a terminal must be connected to the device to monitor the boot and other procedures. The order of installation and configuration procedures are illustrated in the following flowchart:

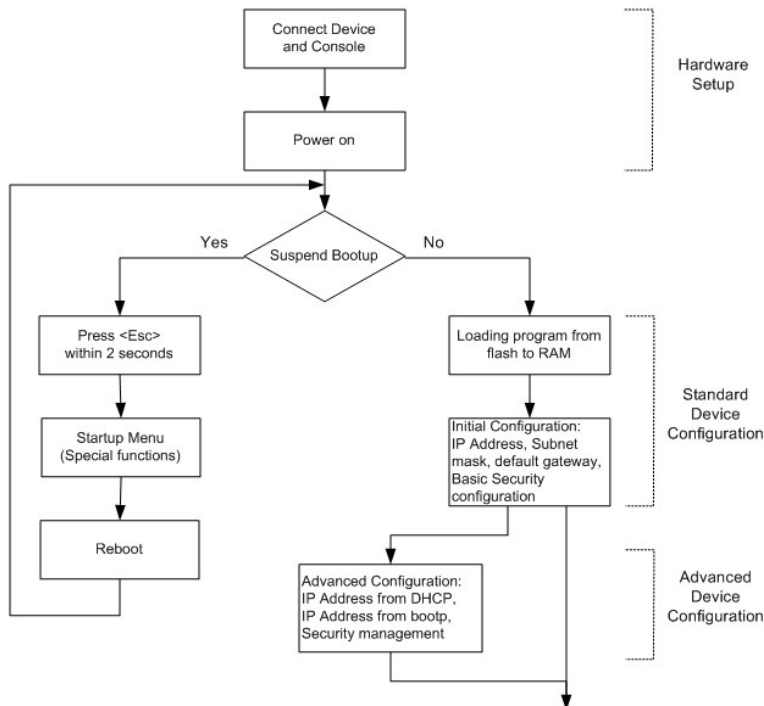

Instructions for setting up the device and hardware are provided in the preceding sections. For a first-time installation, the standard device installation is performed. There are other special functions which can be performed, but this suspends the installation process and results in a system reboot. This option is described later in this section.

General Configuration Information

Dell™ PowerConnect™ 3324/3348 is provided with pre-defined implemented features and setup configuration.

Auto-Negotiation

Auto-negotiation allows a device to advertise modes of operation and share information with another device that shares a point-to-point link segment. This automatically configures both devices to take maximum advantage of their abilities.

Auto-negotiation is performed completely within the physical layers during link initiation, without any additional overhead to either the MAC or higher protocol layers. Auto-negotiation allows the ports to do the following:

- 1 Advertise their abilities.
- 1 Acknowledge receipt and understanding of the common modes of operation that both devices share.
- 1 Reject the use of operational modes that are not shared by both devices.
- 1 Configure each port for the highest-level operational mode that both ports can support.

If connecting a port of the switch to the network interface controller (NIC) of a workstation or server that does not support auto-negotiation or is not set to auto-negotiation, both the switching port and the NIC must be manually set with the Web browser interface or CLI commands to the same speed and duplex mode.

 **NOTICE:** If the station on the other side of the link attempts to auto-negotiate with a port that is manually configured to full duplex, the auto-negotiation results in the station attempting to operate in half duplex. The resulting mismatch may lead to significant frame loss. This is inherent in the auto-negotiation standard.

Switching Port Default Settings

The following table describes the Port default settings.

Function	Default Setting
Port speed and mode	10/100M copper ports: auto-negotiation 1000M auto-negotiation
Port forwarding state	Enabled
Port tagging	No tagging
Head of line blocking prevention	On (Enabled)
Flow Control	Off
Back Pressure	Off

Port Default Settings

The following is an example for changing the port speed on port 1/e5 using CLI commands:

```
console> enable

console# configure

Console (config)# interface ethernet 1/e5

Console (config-if)# speed 100
```

The following is an example for enabling flow control on port 1/e5 using CLI commands:

```
console> enable
```

```
console# configure
```

```
Console (config)# interface ethernet 1/e5
```

```
Console (config-if)# flowcontrol on
```

The following is an example for enabling back pressure on port 1/e5 using CLI commands:

```
console> enable
```

```
console# configure
```

```
Console (config)# interface ethernet 1/e5
```

```
Console (config-if)# back-pressure
```

Baud Rate

The baud rates can be manually changed to any of the following values:

```
1 2400
```

```
1 4800
```

```
1 9600
```

```
1 19,200
```

```
1 38,400
```

```
1 57,600
```

```
1 115,200
```

 **NOTE:** The default baud rate is 9600.

 **NOTE:** Closing the device does not return the default baud rate. It must be specifically configured.

 **NOTE:** In order to enter configuration mode, you must specify administrative level 15 privileges.

The following is an example configuration for changing the default baud rate using CLI commands:

```
console> enable
```

```
console# configure
```

```
console(config)# line console
```

```
console(config-line)# speed 9600
```

```
console(config-if)# exit
```

```
console(config)# exit
```

Terminal Connection Configuration

The PowerConnect 3324/3348 requires the following Terminal Connection parameters for configuration:

- 1 no parity
 - 1 one stop bit
 - 1 8 data bits
-

Other Configuration Requirements

The following is required for downloading embedded software and configuring the device:

- 1 ASCII terminal (or emulation) connected to the Serial port in the back of the unit.
- 1 Assigned IP address for PowerConnect 3324/3348 for device remote control using with Telnet, SSH, etc.

 **NOTE:** The configuration process defines only one port.

Booting the Device

When power is turned on with the local terminal already connected, a device goes through POST (Power On Self Test). This built-in power-on test runs every time the device is initialized. The POST checks hardware components to determine if the device is fully operational before completing boot up.

If a critical problem is detected, the program flow stops. If POST passes successfully, the code is decompressed into the RAM memory.

The POST messages are displayed on the terminal and indicate test success or failure.

To boot the device:

1. Ensure the ASCII cable is connected to the terminal.
2. Connect the power supply to the device; the device begins booting up. The boot-up test first counts the device memory availability and then continues to boot-up. The following screen is an example of the displayed POST test:

```
----- Performing the Power-On Self Test (POST) -----
```

```
UART Channel Loopback Test.....PASS
```

```
Testing the System Cache.....PASS
```

```
Testing the System SDRAM.....PASS
```

Boot1 Checksum Test.....PASS

Boot2 Checksum Test.....PASS

Flash Image Validation Test.....PASS

Testing CPU PCI Bus Device Configuration...PASS

BOOT Software Version 1.30.11 Built 27-JAN-2003 10:06:03

Processor: MPC8245 Rev 0.12, 250 MHz (Bus: 100MHz), 32 MByte SDRAM.

I-Cache 16 KB, linesize 32.D-Cache 16 KB, linesize 32.

Cache Enabled.

Autoboot in 2 seconds - press RETURN or Esc. to abort and enter prom.

The auto-boot message that appears at the end of the POST (see the last lines) indicates that no problems were encountered during boot.

At this point, a user input can be entered to get the Startup menu if it is necessary to run special procedures that can be invoked from this menu. To enter the Startup menu, the <Esc> or <Enter> keys must be pressed within the first two seconds after the auto-boot message appears. For details regarding the Startup menu, see [Startup Menu Functions](#).

If no user input is entered, the system continues operation by decompressing the code into RAM. The code starts running from RAM and the list of available port numbers and their states (up or down) are displayed.

 **NOTE:** The following screen is an example configuration. Items such as addresses, versions, and dates may differ for each device.

Preparing to decompress.

Decompressing SW from RSCOD_2

85e000

OK

Running from RAM.

*****Running SW Ver. 3.30 Date 03-Feb-2003 Time 10:10:37

HW version is X.X

Base Mac address is: 00:01:02:03:04:05

Dram size is: 32M bytes

Dram first block size is: 20M bytes

Dram first PTR is: 0xB70000

Flash size is: 8M

STAND ALONE

The BCM5625_A1 0 initiate successfully

The BCM5625_A1 1 initiate successfully

02-Jan-2000 01:01:11%SSHD-W-NOHOSTKEY: SSHG_init: The SSH daemon cannot listen

for incoming connections, because a host key has not been generated.

The service will start automatically when a host key is generated.

01-Jan-2000 01:01:11 %INIT-I-InitCompleted: Initialization task is completed

console> 01-Jan-2000 01:01:12 %PS-I-PSUP: Power Supply #1 is up

01-Jan-2000 01:01:12%PS-W-PSDOWN: Power Supply #2 is down

01-Jan-2000 01:01:12%LINK-W-Up: 1/e1

01-Jan-2000 01:01:12%LINK-W-UP: 1/e2

01-Jan-2000 01:01:12%LINK-W-Up: 1/e3

01-Jan-2000 01:01:12%LINK-W-UP: 1/e4

01-Jan-2000 01:01:12%LINK-W-Up: 1/e5

01-Jan-2000 01:01:13%LINK-W-Up: 1/e9

After the device has been booted successfully, the system prompt appears (console>) and the configuration process can be started. The local terminal can be used for configuration.

Device Configuration Introduction

There are two types or levels of configuration. The initial configuration describes basic configuration functions with basic security considerations. The advanced configuration includes dynamic IP configuration and more advanced security considerations.

 **NOTICE:** After making any configuration changes, the new configuration must be saved before rebooting. To save the configuration, enter:

```
console> enable
```

```
console# copy running-config startup-config
```

Initial Configuration

Initial configuration starts after the device has booted successfully. The initial configuration scope for the device includes:

- 1 Static IP address and Subnet Mask
- 1 Default gateway
- 1 User name and privilege level must be configured to allow remote management.

If the device is to be managed from an SNMP-based management station, SNMP community strings must also be configured.

Static IP Address and Subnet Mask

In PowerConnect 3324/3348 devices, IP interfaces can be configured on each port and no limitation on the number of IP interfaces is imposed. After entering the configuration command, it is recommended to check if a port was configured with the IP address by entering the "show ip interface" command.

 **NOTICE:** Only one VLAN can be assigned an IP address. If you assign an address to any other VLAN, the new address overrides the original IP address.

To configure an interface on a VLAN, enter the commands at the system prompt as shown in the following configuration example:

```
console> enable
```

```
console# configure
```

```
console(config)# interface vlan 1
```

```
console(config-if)# ip address 100.1.1.1 /8
```

```
console(config-if)# exit
```

```
console(config)# exit
```



```
console# show ip interface
```

```
Gateway IP Address Activity status
```

```
-----
```

```
IP Address I/F
```

```
-----
```

```
100.1.1.1/8 vlan 1
```

```
console#
```

To configure an interface on a port, enter the commands at the system prompt as shown in the following configuration example:

```
console> enable
```

```
console# configure
```

```
console(config)# interface ethernet 1/e1
```

```
console(config-if)# ip address 10.1.1.1 255.0.0.0
```

```
console(config-if)# exit
```

```
console(config)# exit
```

```
console# show ip interface
```

```
Gateway IP Address Activity status
```

```
-----
```

```
IP Address I/F
```

```
-----  
10.1.1.1/8 1/e1
```

```
console#
```

Default Gateway

To manage a PowerConnect 3324/3348 device from a remote network, a default gateway, which is the gateway that a device uses if a specific gateway is not specified, must be configured. The configured gateway IP address must belong to the same subnet as one of the device IP interfaces.

To configure a default gateway, enter the command at the system prompt as shown in this configuration example:

```
console> enable
```

```
console# configure
```

```
console(config)# ip default-gateway 100.1.1.100
```

```
console(config)# exit
```

User Name, Password, and Privilege Level

IMPORTANT: To manage a device from a remote terminal or Web Management Interface, a user name, a password, and the highest privilege level (15) must be entered. (The highest level provides access to the CLI configure context.) For details about the privilege level, see the CLI Reference Guide.

The configured user name is entered as a login name for remote management sessions. To configure user name and privilege level, enter the command at the system prompt as shown in the configuration example:

```
console> enable
```

```
console# configure
```

```
console(config)# username admin password admin level 15
```

```
console(config)# exit
```

SNMP Community Strings

Simple Network Management Protocol (SNMP) provides a method for managing network devices. Devices supporting SNMP run a local software (agent). The SNMP agents maintain a list of variables, used to manage the device. The variables are defined in the Management Information Base (MIB). The MIB presents the variables controlled by the agent. The SNMP agent defines the MIB specification format, as well as the format used to access the information over the network. Access rights to the SNMP agents are controlled by access strings and SNMP community strings.

The device is SNMP-compliant. It contains an SNMP agent that supports a set of standard and private MIB variables. Developers of management stations require the exact structure of the MIB tree and receive the complete private MIBs information before being able to manage the MIBs.

All parameters are manageable from any SNMP management platform, except the SNMP management station IP address and community (community name and access rights). The SNMP management access to the device is disabled if no community strings exist. The device is delivered with no community strings configured.

The following screen displays the default device configuration:

```
console# enable

console# show snmp

Community-String Community-Access IP address
-----

Traps are enabled.

Authentication-failure trap is enabled.
```

The community-string, community-access and IP address can be set during the initial configuration procedure through the local terminal.

The SNMP configuration options are:

- 1 Community string
- 1 Access rights options: ro (read only), rw (read-and-write) or su (super).
- 1 An option to configure IP address or not: if IP address is not configured, it means that all community members having the same community name are granted the same access rights.

The accepted practice is to use two community strings for the device - one (public community) with read only access and the other (private community) with read-and-write access:

- 1 Public — Allow authorized management stations to retrieve MIB objects.
- 1 Private —Allow authorized management stations to retrieve and modify MIB objects.

During initial configuration, it is recommended to configure the device according to the network administrator requirements, in accordance with using an SNMP-based management station.

To configure SNMP station IP address and community string(s):

1. At the console prompt, type **Enable**. The prompt is displayed as #.
2. Type configure and press **<Enter>**.
3. In the configuration mode, type the SNMP configuration command with the parameters including community name (private), community access right (read and write) and IP address, as shown in the example below:

```
console> enable
```

```
config# configure
```

```
config(config)# snmp-server community private rw 11.1.1.2
```

```
config(config)# exit
```

```
config# show snmp
```

```
Community-String Community-Access IP address
```

```
-----
```

```
private readWrite 11.1.1.2
```

```
Traps are enabled.
```

```
Authentication-failure trap is enabled.
```

```
Trap-Rec-Address Trap-Rec-Community Version
```

```
-----
```

```
System Contact:
```

```
System Location:
```

This completes the initial configuration of the device from a local terminal. The configured parameters enable further device configuration from any remote location.

Advanced Configuration

This chapter contains information about dynamic allocation of IP addresses and security management based on the AAA (authentication, authorization and accounting) mechanism. The chapter includes the following topics:

- 1 Configuring IP Addresses through DHCP.
- 1 Configuring IP Addresses through BOOTP.
- 1 Security Management and Password Configuration.

When configuring/receiving IP addresses through DHCP and BOOTP, the configuration received from these servers includes IP address, and may include subnet mask and default gateway.

Retrieving an IP address from a DHCP Server

When using the DHCP protocol to retrieve an IP address, the device acts as a DHCP client.

To retrieve an IP address from a DHCP server:

1. Select and connect any port to a DHCP server or to a subnet which has a DHCP server on it, in order to retrieve the IP address.
2. Enter the following commands to use the selected port for receiving the IP address, as shown in the following example.

```
console> enable
```

```
console# configure
```

```
console(config)# interface vlan 1
```

```
console(config-if)# ip address dhcp hostname <string>
```

```
console(config-if)# exit
```

```
console(config)# exit
```

3. The device receives the IP address automatically.

To verify the IP address:

1. Type **show ip interface** at the system prompt. See the following display example.

```
console> enable
```

```
console# show ip interface
```

```
Gateway IP Address Activity status
```

```
-----
```

```
IP Address I/F
```

```
-----
```

```
10.1.1.1/8 vlan1
```

```
console#
```

 **NOTE:** The device configuration does not need to be deleted to retrieve an IP address for the DHCP server.

Receiving an IP address from a BOOTP Server

The standard BOOTP protocol is supported enabling the device to automatically download their IP host configuration from any standard BOOTP server in the internet. In this case, the device acts as a BOOTP client.

To retrieve an IP address from a BOOTP server:

1. Select and connect any port to a BOOTP server or subnet containing such a server, to retrieve the IP address.
2. At the system prompt, type in the delete startup configuration command to delete the Startup configuration from flash. The device reboots with no configuration and in 60 seconds starts sending BOOTP requests.
3. The device receives the IP address automatically.

 **NOTE:** Once the "delete startup configuration" begins, any input at the ASCII terminal or keyboard automatically aborts the configuration process before completion and the device does not receive an IP address from BOOTP.

The following example illustrates the process:

```
console> enable
```

```
console# delete startup-config
```

To verify the IP address, see the following display example.

```
console> enable
```

```
console# show ip interface
```

```
Gateway IP Address Activity status
```

```
-----
```

```
IP Address I/F
```

```
-----
```

```
10.1.1.1/8 vlan1
```

```
console#
```

Now the device is configured with an IP address.

The device configuration must be deleted to retrieve an IP address from the BOOTP server.

Security Management and Password Configuration

System security is handled through the AAA (Authentication, Authorization and Accounting) mechanism that manages user access rights, privileges and management methods. AAA uses both local and remote user databases. Data encryption is handled through the SSH mechanism.

The system is delivered with no default user name or password configured—all user names and passwords are user-defined. If a user-defined password is lost, a password recovery procedure can be invoked from the Startup menu. The procedure is applicable for the local terminal only and allows a one-time access to the device from the local terminal with no password entered.

 **NOTE:** Ensure that you always include administrative level 15 privileges when entering your user name and password.

Configuring Security Passwords

The security passwords can be configured for the following services:

- 1 Console
- 1 Telnet
- 1 SSH
- 1 HTTP
- 1 HTTPS

 **NOTE:** Passwords are user-defined.

 **NOTE:** When creating a user name, the default priority is "1", which allows access but not configuration rights. A priority of "15" must be specifically set to enable access and configuration rights to the device.

For more information about password limitation, see "[Configuring Network Security](#)".

Configuring an Initial Console Password

To configure an initial console password, enter the following commands:

```
console> enable

console# configure

console(config)# aaa authentication login default line

console(config)# aaa authentication enable default line

console(config)# line console

console(config-line)# login authentication default

console(config-line)# enable authentication default
```

```
console(config-line)# password console
```

```
console(config-line)# exit
```

```
console(config)# exit
```

- 1 When initially logging on to a device through a console session, enter `console` at the password prompt.
- 1 When changing a device's mode to enable, enter `console` at the password prompt.

Configuring an Initial Telnet Password

To configure an initial Telnet password, enter the following commands:

```
console> enable
```

```
console# configure
```

```
console(config)# aaa authentication login default line
```

```
console(config)# aaa authentication enable default line
```

```
console(config)# line telnet
```

```
console(config-line)# login authentication default
```

```
console(config-line)# enable authentication default
```

```
console(config-line)# password admin
```

```
console(config-line)# exit
```

```
console(config)# exit
```

- 1 When initially logging onto a device through a Telnet session, enter `admin`.
- 1 When changing a device mode to enable, enter `admin`.

Configuring an Initial SSH Password

To configure an initial SSH password, enter the following commands:

```
console> enable
```

```
console# configure
```



```
console(config)# aaa authentication login default line
```

```
console(config)# aaa authentication enable default line
```

```
console(config)# line ssh
```

```
console(config-line)# login authentication default
```

```
console(config-line)# enable authentication default
```

```
console(config-line)# password admin
```

```
console(config-line)# exit
```

```
console(config)# exit
```

1 When initially logging onto a device through a SSH session, enter admin as the password.

1 When changing a device's mode to enable, enter admin as the password.

Configuring an Initial HTTP Password

To configure an initial HTTP password, enter the following commands:

```
console> enable
```

```
console# configure
```

```
console(config)# ip http authentication local
```

```
console(config)# username admin password admin level 15
```

```
console(config)# exit
```

Configuring an Initial HTTPS Password

To configure an initial HTTPS password, enter the following commands:

```
console> enable
```

```
console# configure
```

```
console(config)# ip https authentication local
```

```
console(config)# username admin password admin level 15
```

```
console(config)# exit
```

Enter the following commands once when configuring a console, a telnet, or an SSH session in order to use an HTTPS session.

 **NOTE:** In the Web browser, enable SSL 2.0 or greater for the content of the page to appear.

```
console> enable
```

```
console# configure
```

```
console(config)# crypto certificate generate key-generate
```

```
console(config)# ip https server
```

```
console(config)# exit
```

When initially enabling an HTTP or HTTPS session, enter `admin` for user name and `user1` for password.

 **NOTE:** HTTP and HTTPS services require level 15 access and connect directly to the configuration level access.

Sample Configuration Process

The purpose of this chapter is to present the basic steps required in order to establish a remote network management connection with the PowerConnect 3324/3348 device. This chapter does not explain the various configurations available on the device or the relevant commands.

This chapter describes accessing a device for the first time—still with the factory configuration and definitions. If a previously entered configuration causes problems, the startup-configuration file (configuration of device when powered up) should be erased and device rebooted, see "[Device Default Settings](#)".

Device Setup Requirements

The following components are required for the purpose of this example:

- 1 PowerConnect 3324/3348 device
- 1 PC workstation with the following installed:
 - o A NIC (network adapter) card installed
 - o An ASCII terminal application (for example Microsoft® Windows® MS Hyper Terminal or Procomm Plus Terminal)
 - o A browser application
- 1 One Null Modem F2F cable.
- 1 Straight or cross UTP (cat 5) cable(s)

Initial Connection

The initial connection is as follows:

1. Connect the PowerConnect 3324/3348 device to the RS232 interface of a computer operating as an ASCII terminal.
2. Set the ASCII terminal with the following settings and select the appropriate COM port (In this example using Windows Hyper Terminal application):

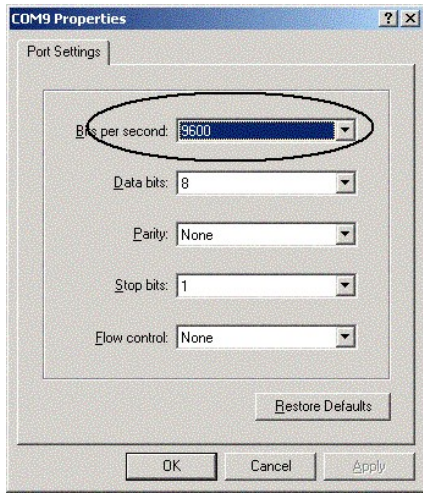

NOTE: 9600 is the default baud rate for new device. If using 9600 baud rate does not result in viewing the device terminal, try another baud rate setting (the device may be set at a different baud rate).

3. Use an F2F Null Modem cable to connect the PC running the ASCII terminal to the device.
4. Insert the device's power cord into an electrical outlet to power up the device. The following screen is displayed:

```

*****

***** SYSTEM RESET *****

*****

Booting...

----- Performing the Power-On Self Test (POST) -----

UART Channel Loopback Test.....PASS

Testing the System Cache.....PASS

Testing the System SDRAM.....PASS

Boot1 Checksum Test.....PASS

Boot2 Checksum Test.....PASS

```

Flash Image Validation Test.....PASS

Testing CPU PCI Bus Device Configuration.....PASS

BOOT Software Version 1.0.0.13 Built 11-May-2003 14:58:20

Processor: MPC8245 Rev 0.14, 250 MHz (Bus: 100MHz), 32 MByte SDRAM.

I-Cache 16 KB, linesize 32.D-Cache 16 KB, linesize 32.

Cache Enabled.

Autoboot in 2 seconds - press RETURN or Esc. to abort and enter prom.

Preparing to decompress...

After the Image file is decompressed the following screen showing device information, SW/HW version, and status (up/down) of all existing interfaces is displayed:

Decompressing SW from image-2

8cc000

OK

Running from RAM...

Update Host params for stand-alone

*** Running SW Ver. 1.0.0.52 Date 29-Jun-2003 Time 19:04:06 ***

HW version is 00.00.01

Base Mac address is: 00:06:5b:ff:59:4d

Dram size is : 32M bytes

Dram first block size is : 20M bytes

Dram first PTR is : 0xB20000

Flash size is: 8M

STAND ALONE

The BCM5615_A1 0 initiate successfully

01-Jan-2000 01:01:10 %SSHD-W-NOHOSTKEY: SSH has been enabled but an encryption key was not found.

For key generation use the 'crypto key generate' commands. The service will start automatically when a host key is generated.

01-Jan-2000 01:01:11 %INIT-I-InitCompleted: Initialization task is completed

console> 01-Jan-2000 01:01:11 %BOX-I-PSUP: Power Supply #1 is up

01-Jan-2000 01:01:11 %BOX-W-PSNOTPRES: Power Supply #2 is not present

01-Jan-2000 01:01:11 %LINK-W-Down: 1/e1

01-Jan-2000 01:01:11 %LINK-W-Down: 1/e2

01-Jan-2000 01:01:11 %LINK-W-Down: 1/e3

.....

.....

Jan-2000 01:01:13 %LINK-W-Down: 1/e22

01-Jan-2000 01:01:13 %LINK-W-Down: 1/e23

01-Jan-2000 01:01:13 %LINK-W-Down: 1/e24

```
01-Jan-2000 01:01:13 %LINK-W-Down: 1/g1
```

```
01-Jan-2000 01:01:13 %LINK-W-Down: 1/g2
```

```
01-Jan-2000 01:01:14 %LINK-I-Up: Vlan 1
```

```
01-Jan-2000 01:01:14 %LINK-I-Up: 1/e1
```

```
console>
```

The device is ready for configuration.

Device Default Settings

To return to device default settings use **delete startup-config** command at the privileged mode prompt (#), and reboot the device. Once device reloads—it is set with the default settings.

```
console>
```

```
console> enable
```

```
console# delete startup-config
```

```
Startup file was deleted
```

```
console# reload
```

This command will reset the whole system and disconnect your current

session. Do you want to continue (y/n) [n] ?

```
y
```

```
*****
```

```
***** SYSTEM RESET *****
```

```
*****
```

Remote Management Access

To allow remote device management (Telnet, Web etc.) perform the following:

1. Enter the command **enable** at the console to enter the Privileged EXEC screen mode as follows:

```
console>enable
```

```
console#
```

2. Connect the management station (PC) to the device via one of the Ethernet ports (or via a network connected to the device) using a CAT5 Cable, to port e1 in this example. Ensure (on the ASCII terminal) that the interface status changed to "up" and that the STP status is forwarding (after 30 seconds):

```
console>enable
```

```
Console#
```

```
01-Jan-2000 01:43:03 %LINK-I-Up: Vlan 1
```

```
01-Jan-2000 01:43:03 %LINK-I-Up: 1/e1
```

```
01-Jan-2000 01:43:34 %STP-I-PORTSTATUS: Port 1/e1: STP status Forwarding
```

3. Enter the command **configure** at the console to enter the Configuration screen mode as follows:

```
console> enable
```

```
console# configure
```

```
console(config)#
```

4. Enter the command **interface ethernet** at the console to enter the Device Configuration screen mode through VLAN1 as follows:

```
console> enable
```

```
console# configure
```

```
console(config)# interface vlan 1
```

```
console (config)# exit
```

5. Define an IP address on the device by assigning an IP address to the interface connected to the management station (in this example 50.1.1.1). If the management station is connected directly to the interface, the IP address on the interface must have the same subnet as the management station.

```
console> enable
```

```
console# configure
```

```
console(config)#
```

```
console(config-if)# ip address 50.1.1.2 /8
```

```
01-Jan-2000 01:48:37 %LINK-W-Down: Vlan 1
```

```
console(config-if)# exit
```

```
console(config)# exit
```

6. If the management station is not directly connected to the interface, that is a member of a remote network, define a default gateway on the device. The gateway configured IP address is the router interface IP connected to the device.

```
console> enable
```

```
console# configure
```

```
console(config-if)#
```

```
console(config-if)# exit
```

```
console(config)# ip default-gateway 50.1.1.100
```

```
console(config)# exit
```

7. Ping the management station from device to make sure that connectivity has been achieved (wait 30 seconds for port to be in STP forwarding before doing this). Management station IP is (in this example) 50.1.1.3:

```
console> enable
```

```
console# configure
```

```
console(config)#
```

```
console(config)# exit
```

```
console# ping 50.1.1.2
```



```
64 bytes from 50.1.1.2: icmp_seq=1. time=0 ms
```

```
64 bytes from 50.1.1.2: icmp_seq=2. time=0 ms
```

```
64 bytes from 50.1.1.2: icmp_seq=3. time=0 ms
```

```
64 bytes from 50.1.1.2: icmp_seq=4. time=0 ms
```

```
---50.1.1.2 PING Statistics---
```

```
4 packets transmitted, 4 packets received, 0% packet loss
```

```
round-trip (ms) min/avg/max = 0/0/0
```

```
console#
```

8. Define a username and password to allow full (privileged level 15) device access for a remote user (telnet, Web Server etc.). In this example the username and password is "Dell".

```
console#
```

```
console# configure
```

```
console(config)# username Dell password Dell level 15
```

```
console(config)#
```

9. Configure Console, Telnet, SSH, HTTP, and HTTPS security passwords:

```
console> enable
```

```
console# configure
```

```
console(config)# aaa authentication login default line
```

```
console(config)# aaa authentication enable default line
```

```
console(config)# line console
```

```
console(config-line)# login authentication default
```

```
console(config-line)# enable authentication default
```

```
console(config-line)# password admin
```

```
console(config-line)# exit
```

```
console(config)# aaa authentication login default line
```

```
console(config)# aaa authentication enable default line
```

```
console(config)# line telnet
```

```
console(config-line)# login authentication default
```

```
console(config-line)# enable authentication default
```

```
console(config-line)# password admin
```

```
console(config-line)# exit
```

```
console(config)# aaa authentication login default line
```

```
console(config)# aaa authentication enable default line
```

```
console(config)# line ssh
```

```
console(config-line)# login authentication default
```

```
console(config-line)# enable authentication default
```

```
console(config-line)# password admin
```

```
console(config-line)# exit
```

```
console(config)# ip http authentication local
```

```
console(config)# username admin password admin 15
```

```
console(config)# ip https authentication local
```

```
console(config)# username admin password admin 15
```

```
console(config)# crypto certificate generate key-generate
```

```
console(config)# ip https server
```

```
console(config)# exit
```

```
console# copy running-config startup-config
```

The device is now configured and is ready for running the Web Management Interface.

Start Running the Management Station

To start running the device perform the following:

1. Define an IP address for the PC which will be used as the remote management station. From the Windows start menu click **Start > Settings > Network and Dial-up Connections**.
2. Right click on the network connection which is used for management. The connection properties window is displayed.

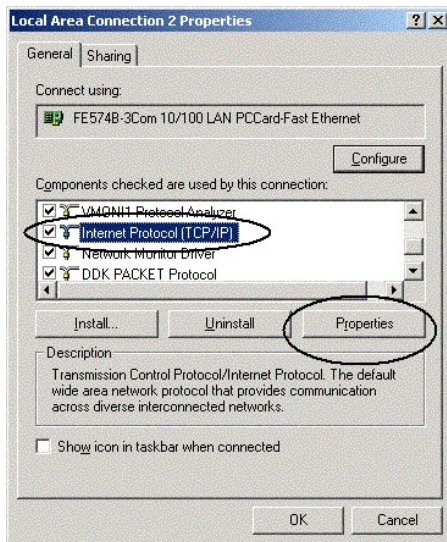

3. Select the option to configure the internet protocol (TCP/IP) and click **Properties**. The Internet Protocol (TCP/IP) properties window is displayed.

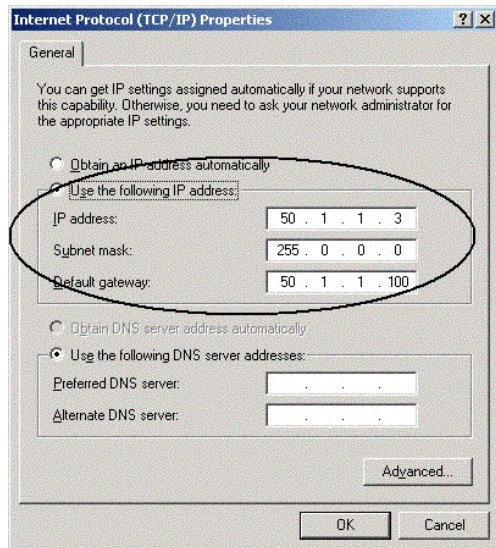

4. Select **Use the following IP address** option.
5. In the Internet Protocol (TCP/IP) properties windows define statically (not via DHCP) an IP address, Mask and default gateway for the PC.

 **NOTE:** If the PC is connected to a router and not directly to PowerConnect 3324/3348 device, the default gateway must be configured as the IP address of the router interface connected to the PC (which leads to the PowerConnect device).

Telnet access

Use windows/DOS command line or a telnet application to access the device via a telnet. Remember to enter the appropriate password. The connection is done with the IP address defined on the device.

Once Access is granted, command usage is the same as in direct device management:

1. Under Windows click **Start>Run** and enter the command cmd. The standard windows command line interface is displayed.
2. Enter the command **Telnet** and the device IP address.

```
Microsoft Windows 2000 [Version 5.00.2195]
```

```
(C) Copyright 1985-2000 Microsoft Corp.
```

```
C:\>telnet 50.1.1.2
```

```
01-Jan-2000 02:40:23 %MSCM-I-NEWTERM: New TELNET connection from 50.1.1.2
```

```
User Name:Dell
```

```
Password:****
```

```
console# show ip interface
```

Gateway IP Address Activity status

50.1.1.100 inactive

IP Address I/F

50.1.1.1/8 vlan 1

console#

Notice that Device indicates (In ASCII terminal) Telnet session status:

```
console> 01-Jan-2000 02:39:04 %MSCM-I-NEWTERM: New TELNET connection from 50.1.1.3
```

```
01Jan-2000 02:39:11 %MSCM-I-TERMTERMINATED: TELNET connection from 50.1.1.3 terminated
```

Web Access (HTTP server)

For web access to the device perform the following:

1. To prevent certain problems which may occur when using an HTTP proxy server, disable (unchecked) proxy setting on the browser (in Microsoft Internet Browser > Tools > Internet Options > Connections > LAN settings):

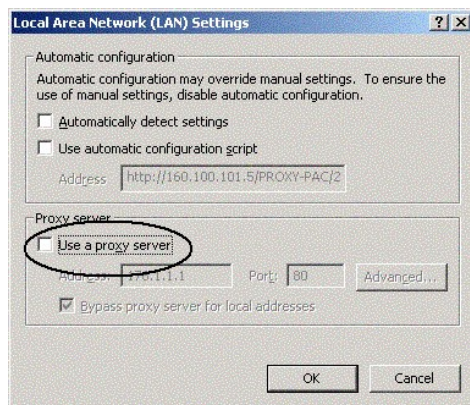

Disabling Proxy Window

2. In the browser window type the IP previously configured on the device (with or without http:// prefix):

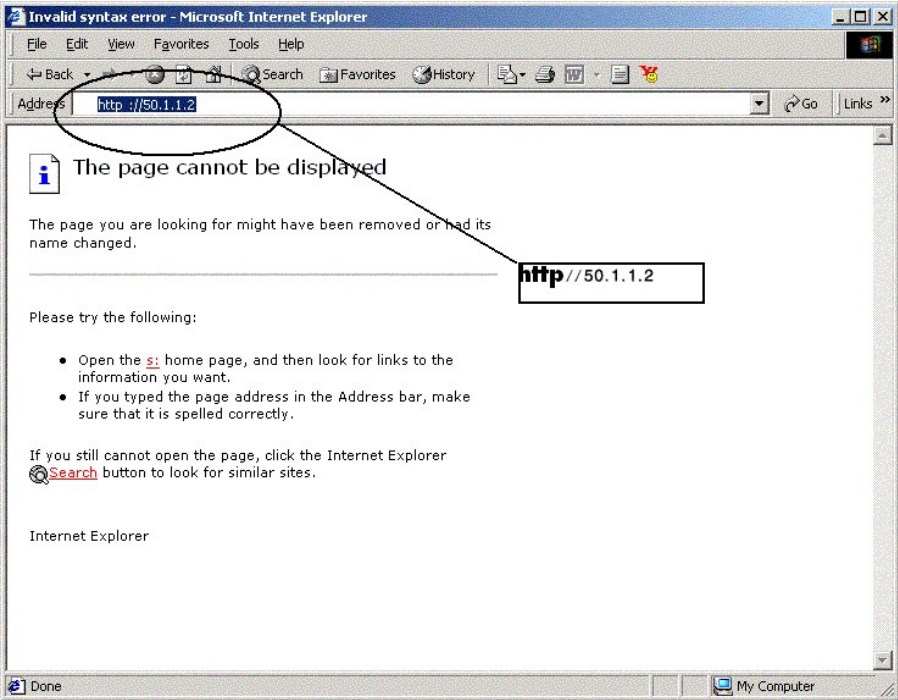

Logging on Interface

3. When the authentication window is displayed, enter the Username and password:



Password Prompt

The device Web Management Interface is displayed.

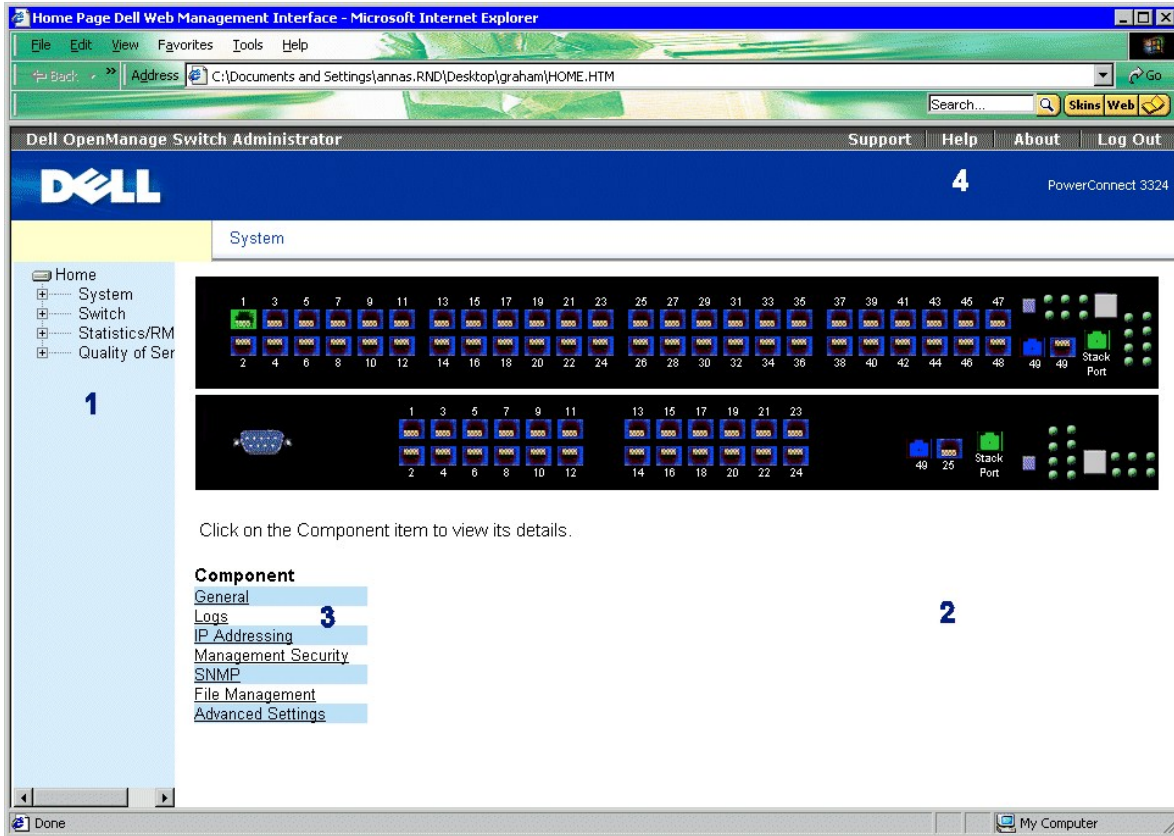

PowerConnect 3324/3348 Web Management Interface

The **PowerConnect 3324/3348 Interface Components Table** lists the interface components with their corresponding numbers:

Configuring Stacking

Stacking Introduction

Stacked PowerConnect 3324/3348 units act as a single system. Each stack has one Master unit, and up to five Member units. The Master unit:

- 1. Manages all member device setup.
- 1. Configures member ports.
- 1. Manages events that occur in the member context.

All stacked unit Event Logs are managed and reported by the selected Master unit. Member units are accessed via the Master unit, although each unit can be accessed through its ASCII terminal (RS-232 port).

Stacking Requirements

Perform the following stacking requirements before you build a stack:

- 1. Ensure each unit has a stack-link module inserted.
- 1. Ensure all cables are properly connected.

1. All units are powered up. After a few seconds, the Unit ID LEDs flashes.
1. Each Member unit has a unit ID. For more information about selecting Unit IDs, see "[Stack ID Button](#)".

Configuring a Stack

This section contains instructions for configuring a stack. To configure a stack:

 **NOTE:** The Stack Unit ID must be selected within 15 seconds.

1. Plug in the selected Master unit. The device begins to boot.
2. Select Unit 1 using the **Stack ID** button until Stacking LED 1 is selected. The LED stops flashing within 15 seconds when the selected unit is the Stack Master.

 **NOTE:** If the stacking LED continues flashing, the Master unit has not joined the group.

3. Plug in the selected Member unit. The device begins to boot.
4. Select Unit 2 using the **Stack ID** button within 15 seconds.
5. Repeat steps 3 and 4 for all stacking members.

 **NOTE:** Stack the units according to their Unit ID. For example, the Master Unit is stacked first, with Unit 2 directly below the Master Unit.

Expanding the Stack

This section contains instructions for adding stacking members. To expand a stack:

 **NOTE:** The Stack Unit ID must be selected within 15 seconds.

1. Ensure that the stack is operating correctly.
2. Connect the lower Stacking connector to the additional stacking Member unit.
3. Plug in new stacking unit. The device begins to boot.
4. Select the unit number using the **Stack ID** button within 15 seconds.
5. For each new member, open the existing ring and connect the new member's Stacking cable.

For information on replacing stacking members and reassigning Unit IDs, see "[Replacing Stack Members](#)".

Rebooting the Device

 **NOTE:** Before rebooting the device, save the device configuration. After the device is reset, all unsaved configuration changes are lost.

1. Enter the CLI mode. The following prompt displays:

```
Console > enable
```

2. Enter Reload. The following message displays:

```
>reload
```

```
This command will restart the whole system and disconnect your current session. Do you want to continue?
```

3. Enter `y`. The device reboots.

Startup Menu Functions

From the Startup Menu, additional device configuration functions are performed. The Startup Menu displays the following configuration functions:

- 1 [Downloading the Software](#)
- 1 [Erasing the FLASH File](#)
- 1 [Erasing FLASH Sectors](#)

The screen below illustrates the Startup Menu:

```
[1] Download Software

[2] Erase Flash File

[3] Erase Flash Sectors

[4] Password Recovery Procedure

[5] Enter Diagnostic Mode

[6] Back

Enter your choice or press 'ESC' to exit: Startup Menu
```

Downloading the Software

Using the Startup Menu

The device software can be downloaded via the Startup menu accessed during the boot process.

To begin downloading the software from the CLI mode:

1. Enter the CLI mode. The following prompt displays:

```
console>
```

2. Type reload. The following message displays:

```
console>reload
```

```
This command will reset the whole system and disconnect your current session. Do you want to continue (y/n)[n]?
```

3. Type y. The device reboots.
4. Press <Return> or <Esc> within 2 seconds. The **Startup** menu displays.

 **NOTE:** The <Return> or <Esc> key must be pressed within 2 seconds in order to display the **Startup** menu.

 **NOTE:** The device times out after 35 seconds if no selection is made. The time out periods can be reset using the CLI.

5. Type 1. The following prompt displays:

```
Downloading code using XMODEM.
```

6. Using any VT100 emulator, select the download file option. The **Send File** window is displayed. Click the **Send** button.

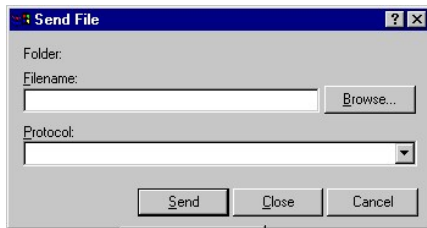

Send File Window

7. Enter the file path for the configuration file.
8. Ensure the protocol is defined as Xmodem.
9. Click **Send**. The software is downloaded.

The device reboots automatically.

 **NOTE:** The TFTP server must be configured before beginning to download the software.

Erasing the FLASH File

The device configuration can be erased using the ASCII terminal. If the configuration is erased, all IP host parameters and parameters configured via CLI, Web Management Interface or SNMP must be reconfigured.

To erase the device configuration:

1. Verify that the ASCII terminal is connected to the device.
2. Connect the power cable. The device boots and the **Startup** menu appears. The device begins to boot.
3. Press <Esc> to exit or <Enter> within two seconds. The **Startup** menu is displayed.
4. Type the number indicating your choice or press <Esc> to exit. Type 2 within two seconds. The following message is displayed:

```
Warning! About to erase the file from flash Are you sure (Y/N)?
```

5. Type Y. The following message is displayed.

```
? Flash file name (8 characters, Enter for none.)
```

6. Enter `config` as the FLASH file name. The configuration is erased and the switch reboots. The IP parameter configuration for a first-time configuration is described in [Device Configuration Introduction](#).

Erasing FLASH Sectors

The FLASH memory stores the executable image, CDB (MIB file), log file, and additional files.

 **NOTICE:** If the FLASH is erased, all software files must be downloaded and installed again.

1. Verify that the ASCII terminal is connected to the device.
2. Connect the power cable. The device boots, and the Startup menu appears.
3. Enter your choice or press <Esc> to exit. Type 3 within two seconds. The following message is displayed:

```
Warning! About to erase Flash Memory! FLASH size = 16252928. blocks = 64 Are you sure (Y/N)?
```

4. Confirm by typing `y`. The following message is displayed:

```
Enter First flash block (1 - 64):
```

5. Enter the first FLASH block to be erased and press <Enter>. The value range is 1-64. The following message is displayed:

```
Enter Last flash block (1 - 64):
```

6. Enter the last FLASH block to be erased and press <Enter>. The following message is displayed:

```
Are you sure (Y/N)?
```

7. Confirm by typing `y`. The following message is displayed:

```
Erasing flash blocks 1 - 1: Done.
```

Password Recovery

To recover an Access Method password:

1. Boot or reboot the device and press <Enter> within 2 seconds. The Startup menu displays. The following figure displays the Startup menu:

```
Startup menu
```

```
[1] Download sw
```

```
[2] Erase from flash
```

```
[3] Erase Flash
```

```
[4] Password Recovery Procedure
```

2. Type 4 and press <Enter>. The access method is reset.

 **NOTE:** To ensure device security, redefine the Console Access Method passwords.

For more information about configuring user passwords, see the *CLI User's Guide*.

Running Diagnostics

Contact Dell technical support before using this option. See "[Contacting Dell](#)".

Downloading the Software to Stacking Units

The software is downloaded from a TFTP server to all stacking units via one of the following methods:

- 1 Sequentially using the CLI
- 1 Individually using the CLI
- 1 Via the Dell OpenManage™ Switch Administrator

Downloading the Software Sequentially Using the CLI

1. Ensure that an IP address is assigned to at least one port on the Master unit.
2. Enter `console# show version` to verify which software version is currently running on each unit. The following is an example of the information which displays:

```
Unit SW version Boot version HW version
```

```
-----
```

```
1 1.0.0.52 1.0.0.13 00.00.01
```

```
2 1.0.0.52 1.0.0.13 00.00.01
```

Each unit's software version, boot version, and hardware version are displayed. In the above example, the units' boot versions and hardware versions differ, while the software version is the same.

3. Enter `console# show bootvar` to verify which image version is active on which unit. The following is an example of the information which displays:

```
Unit Active image Selected for next boot
```

```
-----
```

```
1 image-2 image-2
```

```
2 image-1 image-1
```

Both the active Image file and the Image file that is active after the device is reset are displayed for all units.

4. Enter `console# copy tftp://{tftp address}/{file name} image` to copy the software to the Master unit. The file is copied but does not become active until the file is selected as the Active Image file after the device is reset. The following is an example of the information that displays:

```
console# copy tftp://176.215.31.3/332448-10018.dos image
```

```
Erasing file image-1...done.
```

```
!!!!!!!!!!!!!!!!!!!!!!!!!!!!!!!!!!!!!!!!!!!!!!!!!!!!!!!!!!!!!!!!!!!!!!!!!!!!!!!!!!!!!!!!!!!!!!!!!!!!!!!!!!!!!!!!!!!!!!!!
```

 **NOTE:** Each ! indicates that ten packets were successfully transferred.

Copy: 2739187 bytes copied in 00:01:13 [hh:mm:ss]

5. Enter `console# copy tftp://50.1.1.2/332448-10018.dos unit://2/image`. The device software is copied to the Stacking member 2. unit: the `//2/image` indicates the Stacking member Unit ID to which the software is copied. The following is an example of the information that displays:

```
.....Unit 2: Erased image-1
```

```
!!!!!!!!!!!!!!!!!!!!!!!!!!!!!!!!!!!!!!!!!!!!!!!!!!!!!!!!!!!!!!!!!!!!!!!!!!!!!!!!!!!!!!!!!!!!!!!!!!!!!!!!!!!!!!!!!!!!!!!!!!!!!!!!!!!!!!!!
```

Copy: 2744590 bytes copied in 00:01:41 [hh:mm:ss]

```
console# 01-Jan-2000 01:01:55 %COPY-W-TRAP: The copy operation was completed successfully
```

6. Repeat step 5 for each Stacking member. Ensure that the software is copied to the correct Stacking member Unit ID.
7. Enter `console# boot system image-2` to set the Image file that is used after the device is reset.
8. Enter `console# boot system unit 2 image-1`. This indicates that the device is booted from Image 1 after the reboot.
9. Enter `console# reload`. The following message displays:

```
This command will reset the whole system and disconnect your current
```

```
session. Do you want to continue (y/n) [n]?
```

10. Enter `y`. The device reboots.
11. Repeat steps 2 and 3 to verify which Image files are active.

Downloading the Software Individually Using the CLI

This section contains instructions for individually downloading device software to each stacking member:

- 1 from a TFTP server to a Master Unit
 - 1 from the Master Unit to Member Units
1. Ensure that an IP address is assigned to at least one port on the Master unit.
 2. Enter `console# show version` to verify which software version is currently running on each unit. The following is an example of the information that displays:

```
Unit SW version Boot version HW version
```

```
-----
```

```
1 1.0.0.52 1.0.0.13 00.00.01  
  
2 1.0.0.52 1.0.0.13 00.00.01
```

Each unit's software version, boot version, and hardware version are displayed. In the above example, both units' boot versions and hardware versions differ, while the software version is the same.

3. Enter `console# show bootvar` to verify which image version is currently active on which unit. The following is an example of the information which displays:

This command will reset the whole system and disconnect your current

session. Do you want to continue (y/n) [n] ?

13. Enter `y`. The device reboots.
14. Repeat steps 2 and 3 to ensure the correct Image file is active.

Downloading the Software Via the PowerConnect 3324/3348 Dell OpenManage Switch Administrator

For instructions on downloading the software via the Dell OpenManage Switch Administrator, see "[Managing Files](#)".

Defining SNMP Settings

Simple Network Management Protocol (SNMP) provides a method for managing network devices. Devices supporting SNMP run local software (agent).

The SNMP agents maintain a list of variables, which are used to manage the device. The variables are defined in the Management Information Base (MIB). The MIB presents the variables controlled by the agent. The SNMP agent defines the MIB specification format as well as the format used to access the information over the network.

Access rights to the SNMP agents are controlled by access strings. To communicate with the device, the Embedded Web Server submits a valid community string for authentication.

The default community strings for the PowerConnect device are:

- 1 Public— Allows authorized management stations to retrieve MIB objects.
- 1 Private—Allows authorized management stations to retrieve and modify MIB objects.

If SNMP is not used:

- 1 Change the default community strings to prevent unauthorized access to the PowerConnect device.
- 1 Delete both of the default community strings. SNMP management access to the PowerConnect device is disabled if no community strings exist.

To delete the strings:

 **NOTE:** To use the configure context, users must be assigned a privilege level of 15.

1. Type `enable`. The prompt displays the "#" sign.
 2. Type `configure` and press `<Enter>`, if the Privileged Exec level global configuration context is not enabled.
 3. Type `no snmp-server community private` and then press `<Enter>` to delete the **private** community string.
 4. Type `no snmp-server community public` and then press `<Enter>` to delete the **public** community string.
 5. Type `exit`. The configuration context is exited.
 6. Type `copy running-config startup-config` and then press `<Enter>` to save the configuration changes.
-

Connecting Devices

After assigning IP addresses to the PowerConnect device, devices are connected to the RJ-45 connectors on the PowerConnect front panel.

 **NOTICE:** If auto negotiation is disabled for an RJ-45 port, the auto-MDI/MDI-X pin signal configuration is also disabled.

To connect a device to an SFP transceiver port:

1. Use the cabling requirements to select an appropriate SFP transceiver type.
2. Insert the SFP transceiver (sold separately) into the SFP transceiver slot.
3. Use the appropriate network cabling to connect a device to the connectors on the SFP transceiver.

 **NOTICE:** When the SFP transceiver acquires a link, the associated integrated 10/100/1000BASE-T port is disabled.

To switch off all equipment, the power supply cable is removed from the power supply socket. The power supply socket should be located near the equipment and should be easily accessible.

A protection mark B confirms that the equipment is in compliance with the protection usage requirements of standards PN-93/T-42107 and PN-EN 55022:1996.

[Back to Contents Page](#)

[Back to Contents Page](#)

Configuring Quality of Service

Dell™ PowerConnect™ 3324/3348 User's Guide

- [Quality of Service \(QoS\) Overview](#)
- [Defining QoS Global Parameters](#)
- [Mapping to Queues](#)

This section provides information for defining and configuring Quality of Service (QoS) parameters.

- 1 Click **Quality of Service** in the Tree View. The **Quality of Service** page opens.

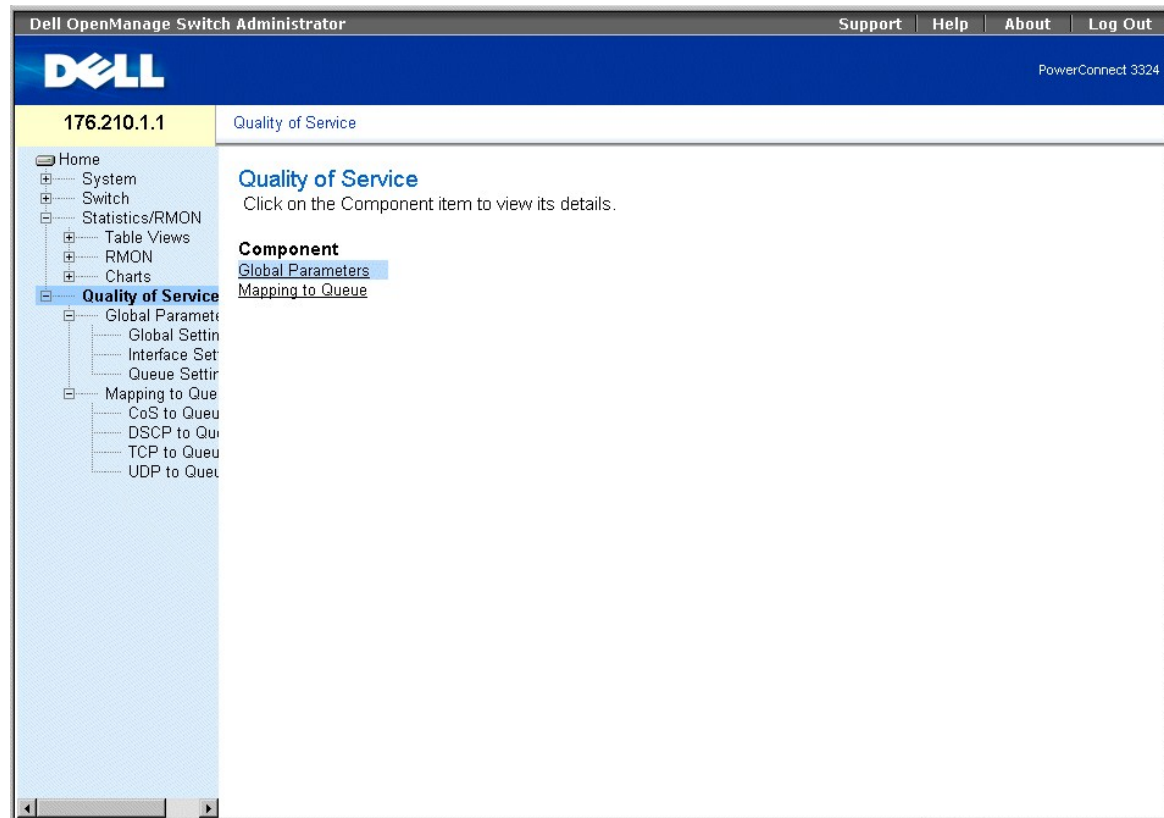

Quality of Service Page

This section includes the following topics:

- 1 [Quality of Service \(QoS\) Overview](#)
- 1 [Defining QoS Global Parameters](#)
- 1 [Mapping to Queues](#)

Quality of Service (QoS) Overview

Quality of Service (QoS) provides the ability to implement QoS and priority queuing within a network. QoS improves network traffic flow based on policies, frame counters, and context.

QoS includes traffic such as voice, video, and real-time traffic that can be assigned a high priority queue, while other traffic can be assigned a lower priority queue. The result is an improved traffic flow for traffic with high demand.

QoS is defined by:

- 1 Classification—Specifies which packet fields are matched to specific values. All packets matching the user-defined specifications are classified together.
- 1 Action—Defines traffic management where packets being forwarded are based on packet information, and packet field values such as VLAN priority (VPT) and DSCP (DiffServ Code Point).
- 1 Prioritization—Traffic is assigned a priority and queued on the appropriate queue for forwarding.

Class of Service (CoS) Information

Eight CoS values can be mapped to one of four forwarding queues (queue 1 to 4). Each queue has a different priority. The first queue has the lowest forwarding priority, while the fourth queue has the highest forwarding priority and is not mapped by default.

 **NOTE:** In a stacking configuration, Queue 4 is used for forwarding stacking traffic. Therefore, assigning additional traffic to Queue 4 may interfere with stack control.

There are three mapping tables:

- 1 CoS to Queue Mapping Table.
- 1 DSCP to Queue Mapping Table.
- 1 TCP/UDP to Queue Mapping Table. The TCP/UDP table is empty by default.

The **CoS to Queue Mapping Table** has default CoS mapping to forwarding queue values:

CoS Value	Forwarding Queue Values
0	q2
1	q1 (Lowest Priority = Best Effort)
2	q1 (Lowest Priority = Best Effort)
3	q2
4	q2
5	q3
6	q3
7	q3

CoS to Queue Mapping Table Default Values

CoS mapping is enabled on a per-system basis. The CoS value order is from zero to seven, where zero is the lowest priority and seven is the highest.

DSCP values can be mapped to priority queues. The **DSCP to Queue Mapping Table Default Values Table** contains the default DSCP mapping to forwarding queue values:

DSCP Value	Forwarding Queue Values
0-7	q1 (Lowest Priority)
8-15	q1
16-23	q2
24-31	q2
32-39	q2
40-47	q3
48-55	q3
55-63	q3 (Highest Priority)

DSCP to Queue Mapping Table Default Values

DSCP mapping is enabled on a per-system basis.

QoS Services

After packets are assigned to a specific queue, QoS services can be assigned to the queue(s). Output queues are configured with a scheduling scheme by one of the following methods:

- 1 Strict Priority—Ensures that time-sensitive applications are always forwarded via an expedited path. Strict priority allows network administrators to prioritize mission-critical, time-sensitive traffic over less time-sensitive applications. For example, under strict priority, voice-over-IP traffic is forwarded before FTP or e-mail (SMTP) traffic. The strict priority queue is emptied before the traffic in the remaining queues is forwarded.
- 1 Weighted Round Robin—Ensures that a single application does not dominate the forwarding capacity of PowerConnect 3324/3348. Weighted Round Robin (WRR) forwards entire queues in a round robin order. Queue priorities are defined by the queue length. The longer the queue length, the higher the queue's forwarding priority. For example, if four queues have queue weights of 1, 2, 3 and 4, packets with the highest forwarding priority are assigned to queue 4, and packets with the lowest forwarding priority are assigned to queue 1. By providing highest forwarding priority to queue 4, weighted round robin processes higher priority traffic and ensures that low-priority traffic is forwarded satisfactorily.

The scheduling scheme is enabled system-wide. Queues assigned to the strict priority policy are automatically assigned to the highest priority queue. By default, all values are set as strict priority. When changing to WRR mode, the default weight value is one. Queue weight values can be assigned in any order using WRR. WRR values can be assigned on a per-system basis. Best effort traffic is always assigned to the first queue. WRR values must be assigned so that Queue 1 remains best effort.

Defining QoS Global Parameters

Quality of Service global parameters are set from the QoS Global Parameter pages. To open the **QoS Global Parameters** page:

- 1 Select **Quality of Service > Global Parameters** in the Tree View. The **QoS Global Parameters** page opens.

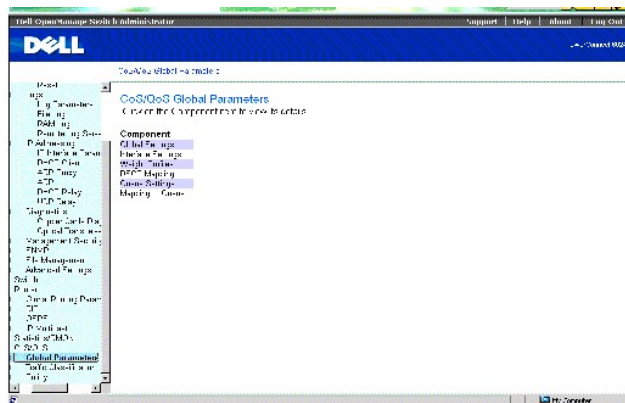

QoS Global Parameters Page

The **QoS Global Parameters** page contains links for:

- 1 [Configuring Global QoS Settings](#)
- 1 [Defining QoS Interface Settings](#)
- 1 [Defining Queue Settings](#)

Configuring Global QoS Settings

The **QoS Global Settings** page allows the user to enable or disable QoS. In addition, the user can select the **Trust** mode. This mode relies on predefined fields within the packet to determine the output queue, thus determining the service for the packet. To open the **QoS Global Settings** page:

- 1 Select **Quality of Service > Global Parameters > Global Settings** in the Tree View. The **QoS Global Settings** page opens.

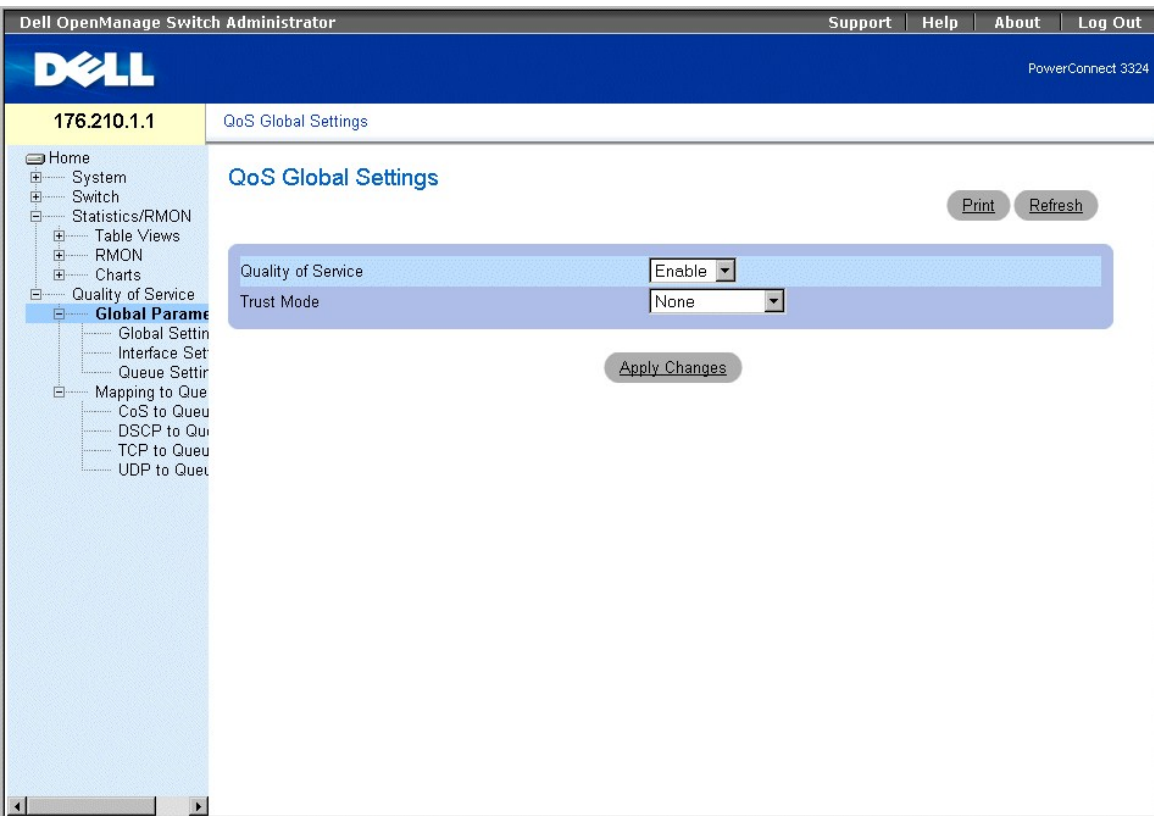

QoS Global Settings Page

The **QoS Global Settings** page contains the following fields:

1. **Quality of Service**—Enables managing network traffic using QoS. The field value options are:
 - o **Enable**—Enable QoS on the device.
 - o **Disable**—Disable QoS on the device.
1. **Trust Mode**—Determines which packet fields to use for classifying packets entering the switch. When no rules are defined the traffic containing the predefined packet field (CoS, DSCP or TCP/UDP port) is mapped according to the relevant trust modes table. Traffic not containing a predefined packet field is mapped to best effort. The possible trust mode field values are:
 - o **CoS**—Indicates the output queue assignment is determined by the IEEE802.1p VLAN priority tag (VPT) or by the default VPT assigned to a port.
 - o **DSCP**—Indicates the output queue assignment is determined by the DSCP field.
 - o **TCP/UDP**—Indicates the output queue is determined by the TCP/UDP port.

NOTE: The interface **Trust** setting overrides the global **Trust** setting.

Enabling Quality of Service:

1. Open the **QoS Global Settings** page.
2. Select **Enable** in the **Quality of Service** field.
3. Click **Apply Changes**. **Quality of Service** is enabled on the device.

Enabling Trust:

1. Open the **QoS Global Settings** page.
2. Select the Trust setting in the **Trust Mode** field.
3. Click **Apply Changes**. Trust is enabled/disabled on the device.

Enabling Trust Using the CLI Commands

The following table summarizes the equivalent CLI commands for configuring fields in the **QoS Global Settings** page.

CLI Command	Description
<code>qos trust [cos dscp tcp-udp-port]</code>	Configures the system to basic mode and the trust state.
<code>qos</code>	Enables QoS on the device.
<code>no qos trust</code>	Returns to the non-trust state.

The following is an example of the CLI commands:

```
Console (config)# qos
```

```
Console (config)# qos trust dscp
```

Defining QoS Interface Settings

The **QoS Interface Settings** page enables the user to define, per interface, if the selected Trust mode is to be activated. The default priority for incoming untagged packets is also selected in the **QoS Interface Settings** page. To open the **QoS Interface Settings** page:

- 1 Click **Quality of Service > Global Parameters > Interface Settings** in the Tree View. The **QoS Interface Settings** page opens.

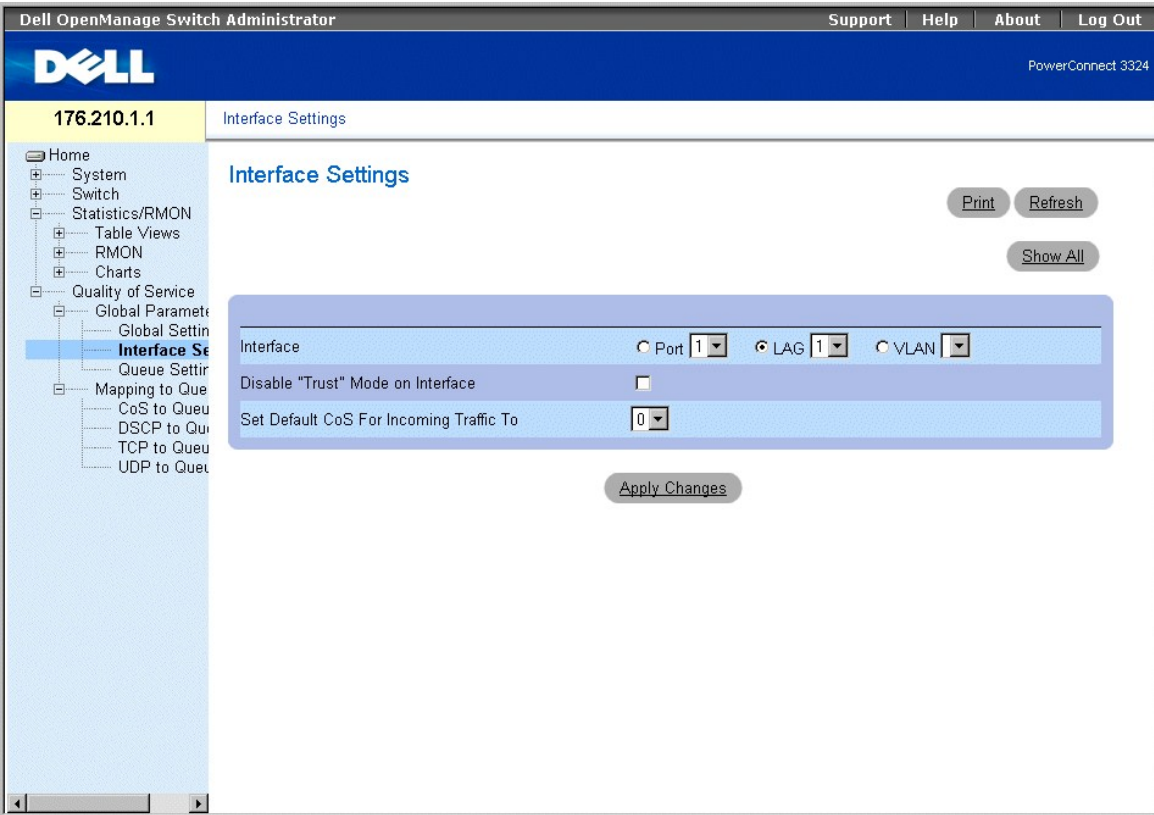

Interface Settings Page

The **QoS Interface Settings** page contains the following fields:

1. **Interface**—Indicates the specific interface to which the Trust mode is applied. The trust mode is applied to:
 - o **Port**—Indicates the port number.
 - o **LAG**—Indicates the LAG number.
 - o **VLAN**—Indicates the VLAN number.
1. **Disable "Trust" Mode on Interface**—Disables Trust values on the device. For more information about Trust settings, see "[Configuring Global QoS Settings](#)".
1. **Set Default CoS For Incoming Traffic To**—Sets the default CoS tag value untagged packets. The CoS tag values are 0-7. The default value is 0.

Assigning QoS/CoS settings for an interface:

1. Open the **QoS Interface Settings** page.
2. Select an interface in the **Interface** field.
3. If trust mode is to be disabled on the specific interface, check the **Disable "Trust" Mode on Interface** check box.
4. Set **Default CoS For Incoming Traffic** to the required value.
5. Click **Apply Changes**. The QoS/CoS settings are assigned to the interface.

Assigning QoS/CoS Interfaces Using the CLI Commands

The following table summarizes the equivalent CLI commands for configuring fields in the **QoS Interface Settings** page.

CLI Command	Description
qos trust	Enables trust state for each.

<code>qos cos default-cos</code>	Configures the default port CoS value.
<code>no qos trust</code>	Disables Trust state on each port.

The following is an example of the CLI commands:

```
Console (config)# interface ethernet 1/e5
```

```
Console (config-if)# qos trust
```

```
Console (config-if)# qos cos 3
```

Defining Queue Settings

The **Queue Settings** page allows network administrators to configure Weighted Round Robin (WRR), as well as assign bandwidth values for queues. Each queue is configured with different WRR and Weighted Random Early Detection (WRED) values. To open the **Queue Settings** page:

- 1 Select **Quality of Service > Global Parameters > Queue Settings** in the Tree View. The **Queue Settings** page opens.

The screenshot shows the Dell OpenManage Switch Administrator interface. The top navigation bar includes 'Support', 'Help', 'About', and 'Log Out'. The main header displays the Dell logo and 'PowerConnect 3324'. The left sidebar shows a tree view with 'Queue Settings' selected. The main content area is titled 'Queue Settings' and contains a table with the following data:

Queue	Strict Priority	WRR Weight (1-255)	% of WRR Bandwidth
1	<input checked="" type="checkbox"/>	<input type="text"/>	<input type="text"/>
2	<input checked="" type="checkbox"/>	<input type="text"/>	<input type="text"/>
3	<input checked="" type="checkbox"/>	<input type="text"/>	<input type="text"/>
4	<input checked="" type="checkbox"/>	<input type="text"/>	<input type="text"/>

Buttons for 'Print', 'Refresh', and 'Apply Changes' are visible on the page.

Queue Setting Page

The **Queue Settings** page contains the following fields:

- 1 **Queues**—Indicates the queue number.

NOTE: Overloading a queue may cause network congestion.

- 1 **Strict Priority**—Specifies if traffic scheduling is based strictly on the queue priority. The default is enabled.
- 1 **WRR**—Specifies if traffic scheduling for the queue is based on the WRR scheme.

- 1 **WRR Weight**—Assigns WRR weights to egress queues. The possible field values are 1–255, where 1 is the lowest value and 255 is the highest value.
- 1 **% of WRR Bandwidth**—Indicates the amount of bandwidth assigned to the WRR.

Defining the Queue Settings:

1. Open the **Queue Settings** page.
2. Define **Scheduling**, **WRR Weight**, and **Bandwidth** fields.
3. Click **Apply Changes**. The **Queue Settings** page and the device are updated.

Assigning Queue Setting Using the CLI Commands

The following table summarizes the equivalent CLI commands for configuring fields in the **Queue Settings** page.

CLI Command	Description
<code>wrr-queue bandwidth weight1 weight2 . weight_n</code>	Assigns Weighted Round Robin (WRR) weights to egress queues.
<code>show qos interface [interface-id] [queuing]</code>	Displays interface QoS data.

The following is an example of the CLI commands:

```
Console (config)# wrr-queue bandwidth 10 20 30 40
```

```
Console (config)# exit
```

```
Console # exit
```

```
Console> show qos interface ethernet 1/e3 queuing
```

```
Ethernet 1/e3
```

```
wrr bandwidth weights and EF priority:
```

```
qid-weights EF - Priority
```

```
1 - 10 dis- N/A
```

```
2 - 20 dis- N/A
```

```
3 - 30 dis- N/A
```

```
4 - 1 dis- N/A
```

```
Cos-queue map:
```

```
cos-qid
```

0 - 2

1 - 1

2 - 1

3 - 2

4 - 2

5 - 3

6 - 3

7 - 3

Mapping to Queues

The **Mapping to Queue** page contains links to pages for mapping CoS and DSCP values, as well as TCP and UDP ports to QoS queues. To open the **Mapping to Queue** page:

1. Select **Quality of Service > Mapping to Queue**. The **Mapping to Queue** page opens.

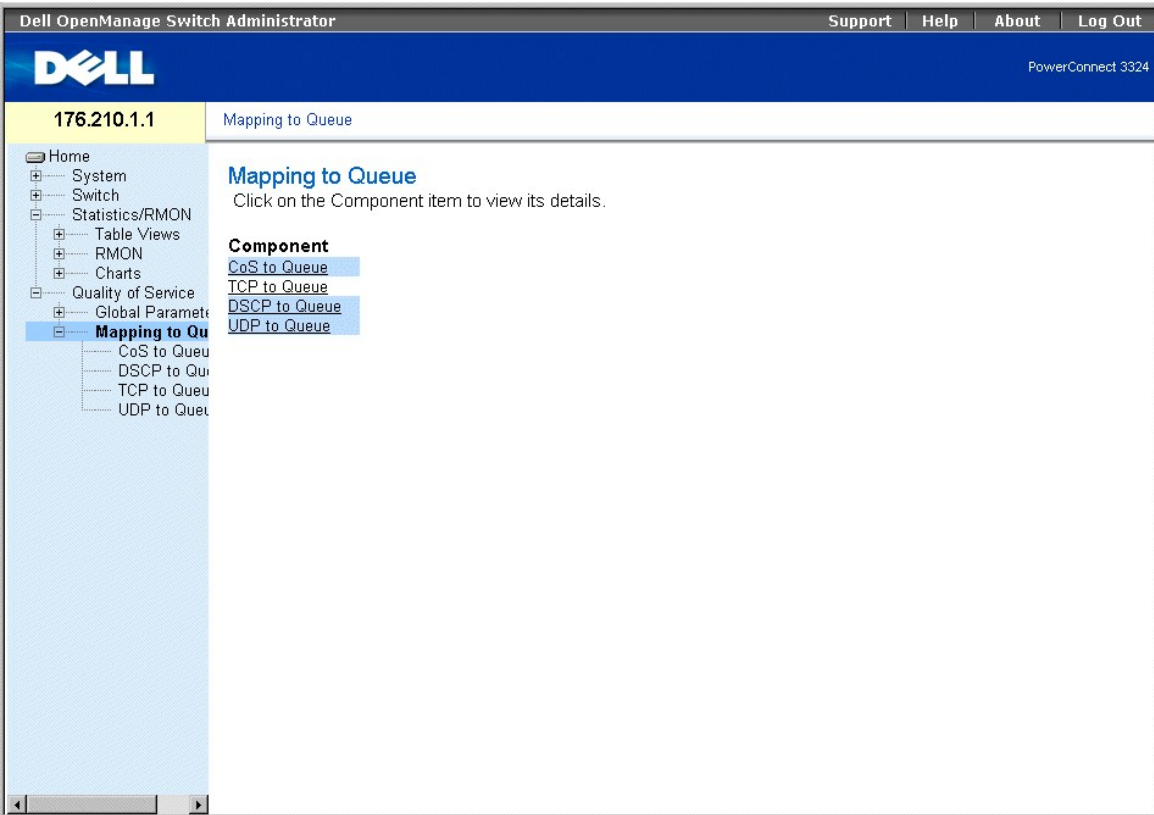

Mapping to Queue Page

The **Mapping to Queue** page includes links to the following topics:

- 1 [Mapping CoS Values to Queues](#)
- 1 [Mapping TCP Port Values to Queues](#)
- 1 [Mapping DSCP Values to Queues](#)
- 1 [Mapping UDP Port Values to Queues](#)

Mapping CoS Values to Queues

The **CoS to Queue** page allows network administrators to classify CoS settings to traffic queues. To open the **CoS to Queue Mapping Table** page:

- 1 Select **Quality of Service > Mapping to Queue > CoS to Queue** in the Tree View. The **CoS to Queue Mapping Table** page opens.

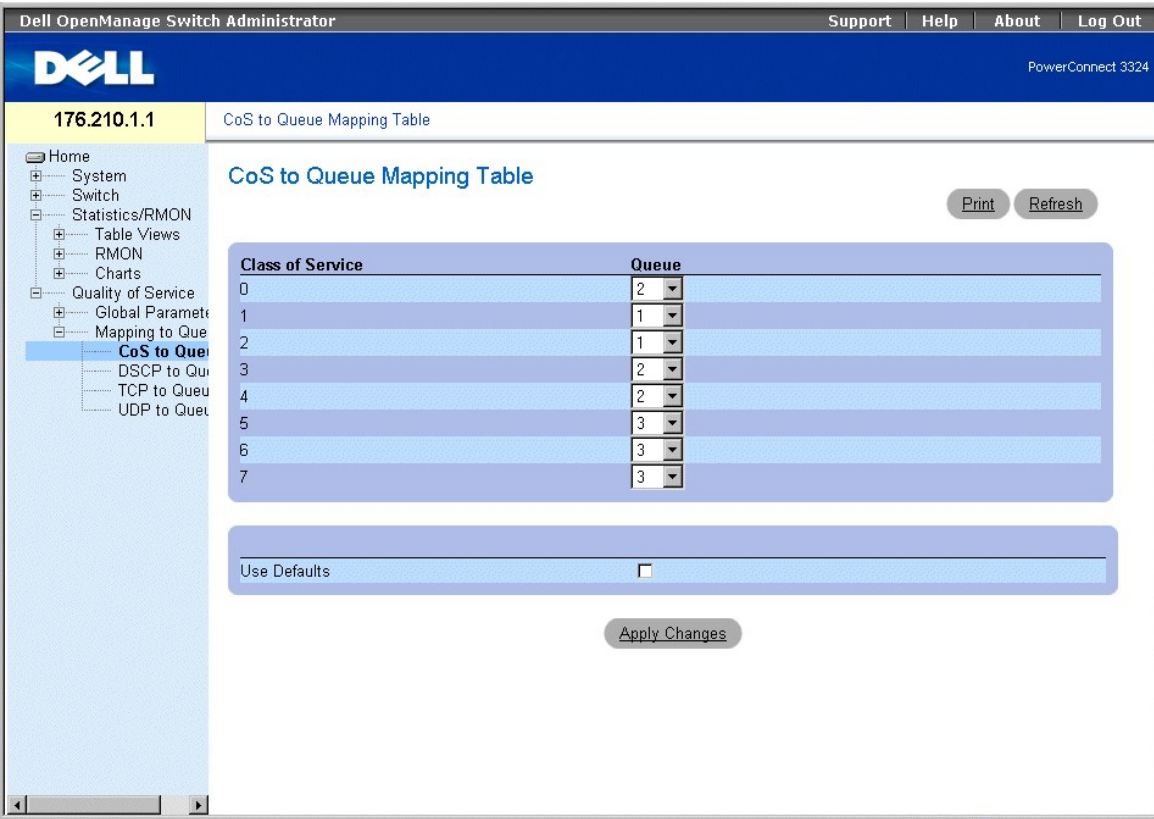

CoS to Queue Mapping Table Page

The **CoS to Queue Mapping Table** page contains the following fields:

- 1 **Class of Service**—Specifies the CoS priority tag values, where zero is the lowest and seven is the highest.
- 1 **Queue**—Indicates the traffic forwarding queue to which the CoS priority is mapped. Four traffic priority queues are supported.

NOTE: In a stacking configuration, Queue 4 is used for forwarding stacking traffic. Therefore, assigning additional traffic to Queue 4 may interfere with stack control.

- 1 **Use Defaults**—Uses the device defaults for mapping CoS values to a forwarding queue.

Mapping a CoS value to a Queue:

1. Open the **CoS to Queue** page.
2. Select a CoS entry.
3. Define the queue number in the **Queue** field.
4. Click **Apply Changes**. The CoS value is mapped to a queue, and the device is updated.

Assigning CoS Values to Queues Using the CLI Commands

The following table summarizes the equivalent CLI commands for configuring fields in the **Mapping CoS Values to Queues Table**.

CLI Command	Description
<code>wrr-queue cos-map queue-id cos1.cosn</code>	Maps assigned CoS values to the egress queues.

The following is an example of the CLI commands:

```
Console (config)# wrt queue cos-map 4 7
```

Mapping DSCP Values to Queues

The **DSCP Mapping** page allows network managers to determine the output queue that is assigned per a specific DSCP field. To open the **DSCP Mapping** page:

 **NOTE:** See DSCP to Queue Mapping Table Default Values for the list of DSCP default queue settings.

1. Select **Quality of Service > Global Parameters > Global Settings > DSCP Mapping** in the Tree View. The **DSCP Mapping** page opens.

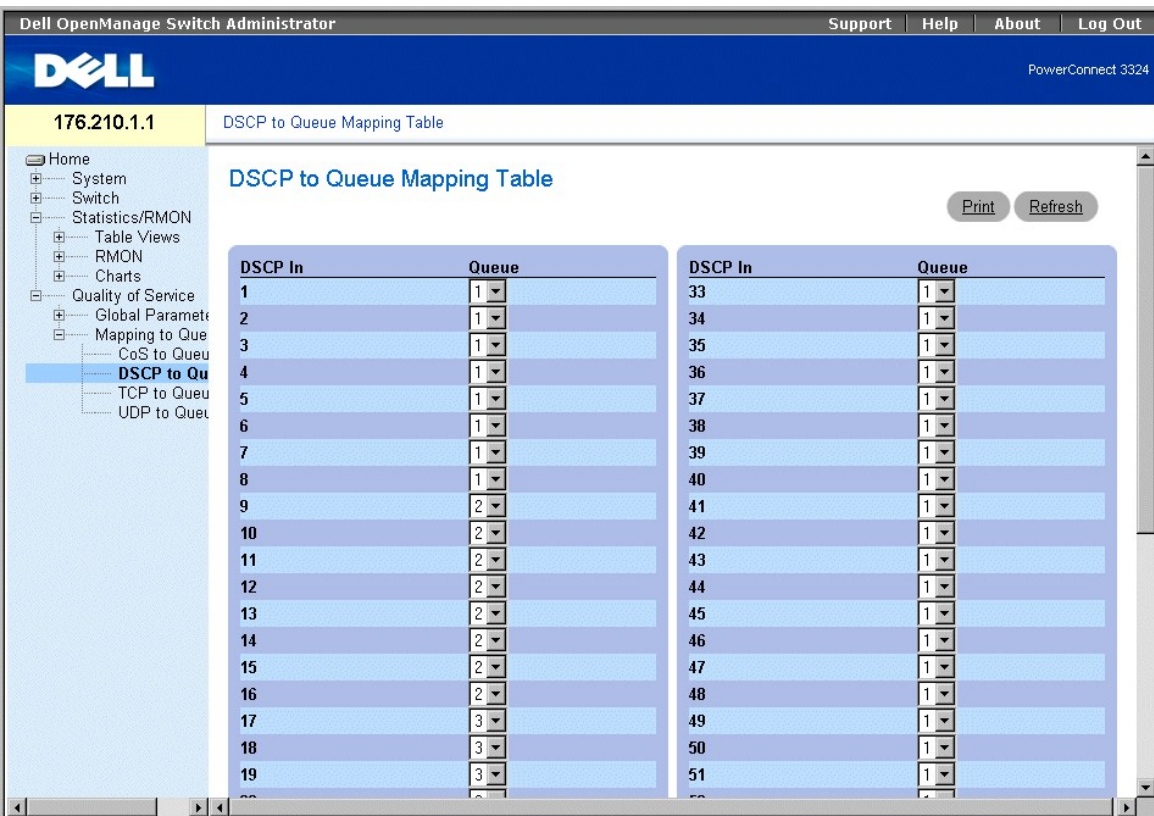

Dell OpenManage Switch Administrator

Support Help About Log Out

PowerConnect 3324

176.210.1.1 DSCP to Queue Mapping Table

DSCP to Queue Mapping Table

Print Refresh

DSCP In	Queue	DSCP In	Queue
1	1	33	1
2	1	34	1
3	1	35	1
4	1	36	1
5	1	37	1
6	1	38	1
7	1	39	1
8	1	40	1
9	2	41	1
10	2	42	1
11	2	43	1
12	2	44	1
13	2	45	1
14	2	46	1
15	2	47	1
16	2	48	1
17	3	49	1
18	3	50	1
19	3	51	1

DSCP Mapping Page

The For the list of the DSCP default queue settings, contains the following fields:

 **NOTE:** In a stacking configuration, Queue 4 is used for forwarding stacking traffic. Therefore, assigning additional traffic to Queue 4 may interfere with stack control.

1. **DSCP In**—Indicates the values of the DSCP field within the incoming packet.
1. **Queue**—Indicates the queue to which packets with the specific DSCP value are assigned. The values are 1-4, where one is the lowest and four is the highest value.

Mapping a DSCP value and assigning priority queue:

1. Open the **DSCP Mapping** page.

2. Select a value in the **DSCP In** column.
3. Define the **Queue** fields.
4. Click **Apply Changes**. The DSCP is not overwritten, and the value is assigned a forwarding queue.

Assigning DSCP Values Using the CLI Commands

The following table summarizes the equivalent CLI commands for configuring fields in the **DSCP Mapping** page.

CLI Command	Description
<code>qos map dscp-queue dscp-list to queue-id</code>	Modifies the DSCP to queue mapping.

The following is an example of the CLI commands:

```
Console (config)# qos map dscp-queue 33 40 41 to 1
```

Mapping TCP Port Values to Queues

The **TCP to Queue** page allows network managers to classify specific TCP destination port traffic to queues. To open the **TCP to Queue** page:

1. Select **Quality of Service > Mapping to Queue > TCP to Queue** in the Tree View. The **TCP to Queue** page opens.

The screenshot shows the Dell OpenManage Switch Administrator interface. The top navigation bar includes 'Support', 'Help', 'About', and 'Log Out'. The main header displays the Dell logo and 'PowerConnect 3324'. The left sidebar shows a tree view with 'Quality of Service' expanded to 'Mapping to Queue', where 'TCP to Queue' is selected. The main content area is titled 'TCP to Queue' and contains the following elements:

- Buttons: Print, Refresh, Show All
- Form:
 - Radio button selected: Select TCP Port from List (FTP-21)
 - Radio button: Insert TCP Port
 - Text input: Map to Queue (1)
- Remove button
- Apply Changes button

TCP to Queue Page

The **TCP to Queue** page contains the following information:

- 1 **Select TCP Port from List**—Provides a drop-down list of predefined commonly used TCP ports.
- 1 **Insert TCP Port**—Enables defining a new TCP port.
- 1 **Map to Queue**—Indicates the traffic queue to which the TCP port is assigned.

 **NOTE:** In a stacking configuration, Queue 4 is used for forwarding stacking traffic. Therefore, assigning additional traffic to Queue 4 may interfere with stack control.

- 1 **Remove**—Removes a TCP port mapping.
 - o **Checked**—Removes a specific TCP port mapping.
 - o **Unchecked**—Maintains a TCP port mapping.

Assigning a TCP port to a Traffic Queue:

1. Open the **TCP to Queue** page.
2. Select a port in the **TCP Port List**.

Or

Check the **Insert TCP Port** check box. The **New TCP Port** field is enabled. Define a new TCP port.

3. Select a queue number in the **Map to Queue** drop-down list.
4. Click **Apply Changes**. The TCP port is assigned a forwarding queue.

Modifying a TCP Port to Traffic Queue Setting:

1. Open the **TCP to Queue** page.
2. Select a port in the **TCP Port List** drop-down list. The queue to which the port is assigned displays in the **Map to Queue** drop-down list.
3. Select a new traffic queue in the **Map to Queue** drop-down list.
4. Click **Apply Changes**. The TCP port is reassigned to a different traffic queue.

Displaying the TCP to Queue Mapping Table:

1. Open the **TCP to Queue** page.
2. Click **Show All**. The **TCP to Queue Mapping Table** opens.

TCP to Queue Mapping Table

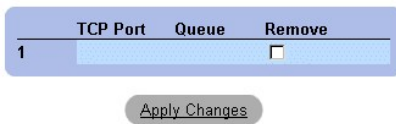

TCP Port	Queue	Remove
1		<input type="checkbox"/>

[Apply Changes](#)

TCP to Queue Mapping Table

Removing a TCP port mapping from the **TCP to Queue Mapping Table**:

1. Open the **TCP to Queue** page.
2. Click **Show All**. The **TCP to Queue Mapping Table** opens.
3. Select a port in the **TCP Port List** drop-down list. The queue to which the port is assigned displays in the **Map to Queue** drop-down list.
4. Check the **Remove** check box.
5. Click **Apply Changes**. The TCP port is removed from the traffic queue.

Assigning TCP Ports to Queues Using the CLI Commands

The following table summarizes the equivalent CLI commands for configuring fields in the **TCP to Queue** page.

CLI Command	Description
<code>qos map tcp-port-queue port1.port8 to queue-id</code>	Modifies the TCP-Port to queue.
<code>show qos map tcp-port-queue</code>	Displays the TCP-Port to queue.
<code>no qos map tcp-port-queue</code>	Removes the TCP port from a queue.

The following is an example of the CLI commands:

```
Console (config)# qos map tcp-port-queue 6001 to 2
```

```
Console (config)# exit
```

```
Console # exit
```

```
Console (config)# show qos map tcp-port-queue
```

```
Tcp port-queue map:
```

```
Port queue
```

```
-----
```

```
6000 1
```

```
6001 2
```

```
6002 3
```

Mapping UDP Port Values to Queues

The **UDP to Queue** page allows network managers to classify specific UDP port traffic to queues. To open the **UDP to Queue** page:

- 1 Select **Quality of Service > Mapping to Queue > UDP to Queue** in the Tree View. The **UDP to Queue** page opens.

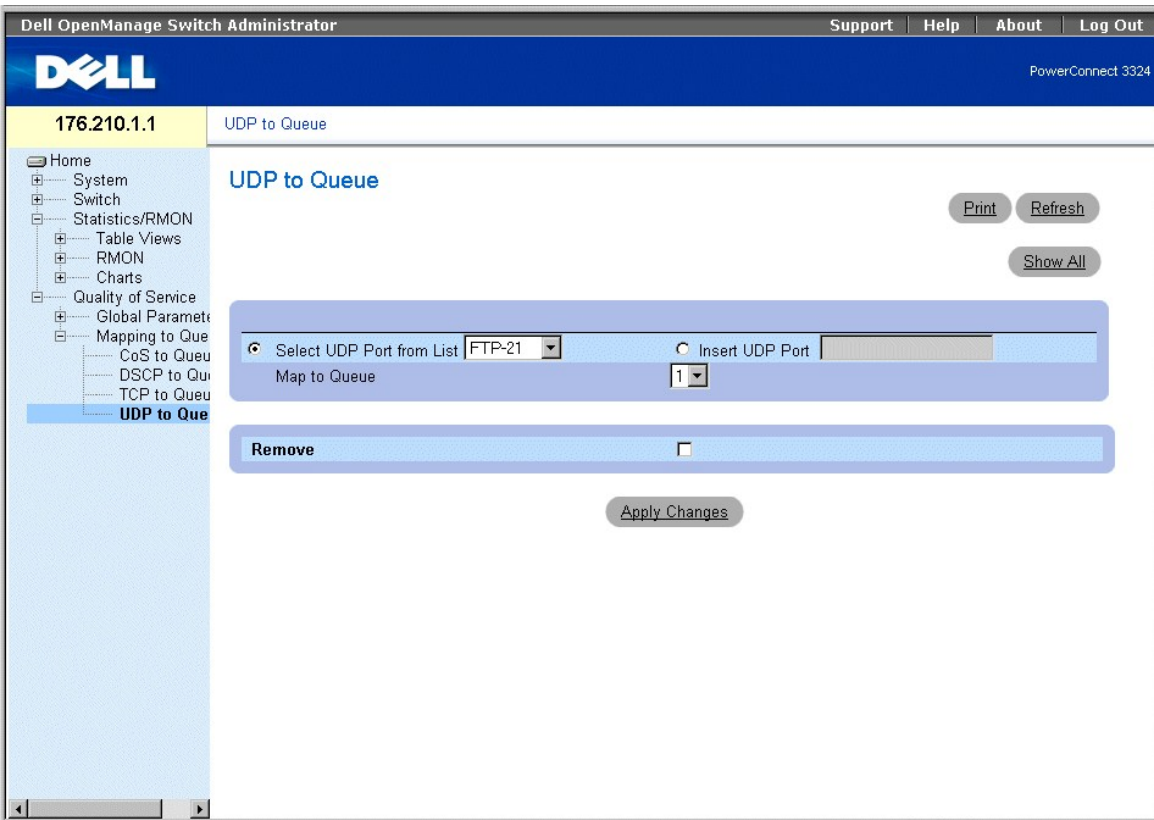

UDP to Queue Page

The **UDP to Queue** page contains the following fields:

- 1 **Select UDP from the List**—Provides a drop-down list of predefined commonly used UDP ports.
- 1 **Insert UDP Port**—A new UDP port may be defined.
- 1 **Map to Queue**—Indicates the traffic queue to which the UDP port is assigned.

 **NOTE:** In a stacking configuration, Queue 4 is used for forwarding stacking traffic. Therefore, assigning additional traffic to Queue 4 may interfere with stack control.

- 1 **Remove**—Removes UDP port mapping.
 - o **Checked**—Removes a UDP port mapping.
 - o **Unchecked**—Maintains a UDP port mapping.

Assigning a UDP port to a Traffic Queue:

1. Open the **UDP to Queue** page.
 2. Select a port in the **UDP Port List**.
- Or
- Check the **Insert UDP Port** check box. The **New UDP Port** field is enabled.
- Define a new UDP port.
3. Select a queue number in the **Map to Queue** drop-down list.
 4. Click **Apply Changes**. The UDP port is assigned a forwarding queue.

Modifying a UDP Port to Traffic Queue Setting:

1. Open the **UDP to Queue** page.

2. Select a port mapping in the **UDP Port List** drop-down list. The queue to which the port is assigned displays in the **Map to Queue** drop-down list.
3. Select a new traffic queue in the **Map to Queue** drop-down list.
4. Click **Apply Changes**. The UDP mapping is reassigned to a different traffic queue.

Removing a UDP port mapping from a UDP to Traffic Mapping Table:

1. Open the **UDP to Queue** page.
2. Select a port mapping in the **UDP Port List** drop-down list. The queue to which the port is assigned displays in the **Map to Queue** drop-down list.
3. Check the **Remove** check box.
4. Click **Apply Changes**. The UDP port mapping is removed from the UDP to the Traffic Mapping Table.

Assigning UDP Ports to Queues Using the CLI Commands

The following table summarizes the equivalent CLI commands for configuring fields in the **UDP to Queue** page.

CLI Command	Description
<code>qos map udp-port-queue <i>port1.port8</i> to <i>queue-id</i></code>	Modifies the UDP-Port to queue.
<code>show qos map udp-port-queue</code>	Displays the UDP-Port to queue.
<code>no qos map udp-port-queue</code>	Removes the UDP port from a queue.

The following is an example of the CLI commands:

```
Console (config)# qos map udp-port-queue 2000 80 to 2
```

```
Console (config)# show qos map udp-port-queue
```

[Back to Contents Page](#)

[Back to Contents Page](#)

Configuring Switch Information

Dell™ PowerConnect™ 3324/3348 User's Guide

- [Configuring Network Security](#)
- [Configuring Ports](#)
- [Configuring Address Tables](#)
- [Configuring GARP](#)
- [Configuring the Spanning Tree Protocol](#)
- [Configuring VLANs](#)
- [Aggregating Ports](#)
- [Multicast Forwarding Support](#)

This section provides all system operation and general information for configuring network security, ports, Address tables, GARP, VLANs, Spanning Tree, Port Aggregation, and Multicast Support.

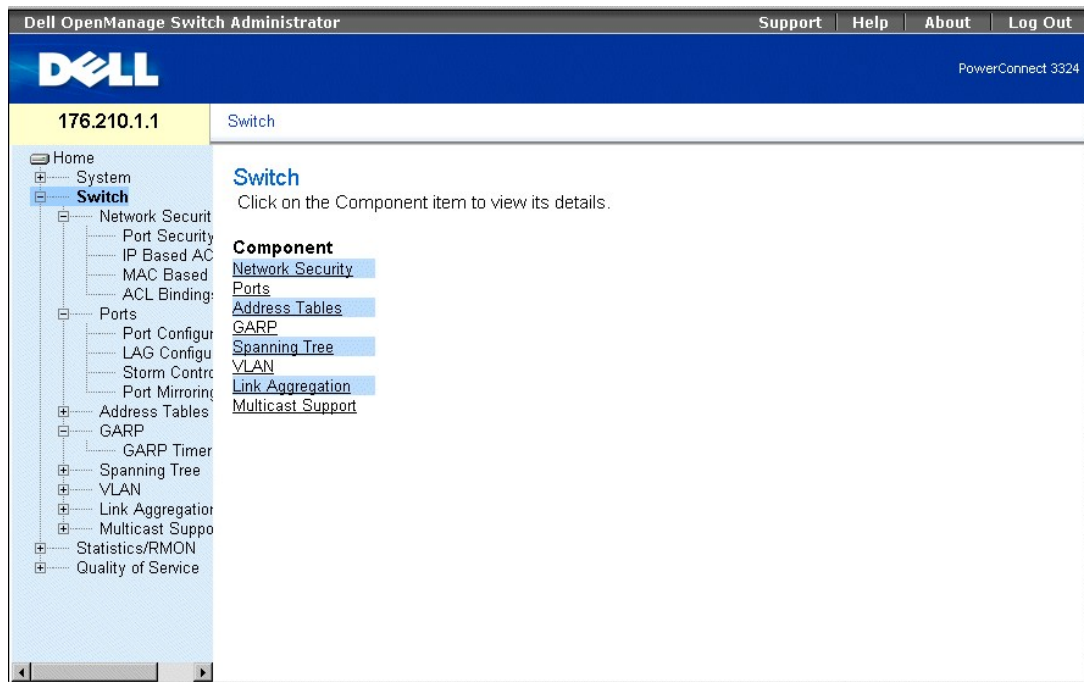

Switch Page

Configuring Network Security

Dell™ PowerConnect™ 3324/3348 allows network managers to set network security through both Access Control Lists and Locked Ports.

To open the **Network Security** page:

1. Select Switch > **Network Security**. The **Network Security** page opens.

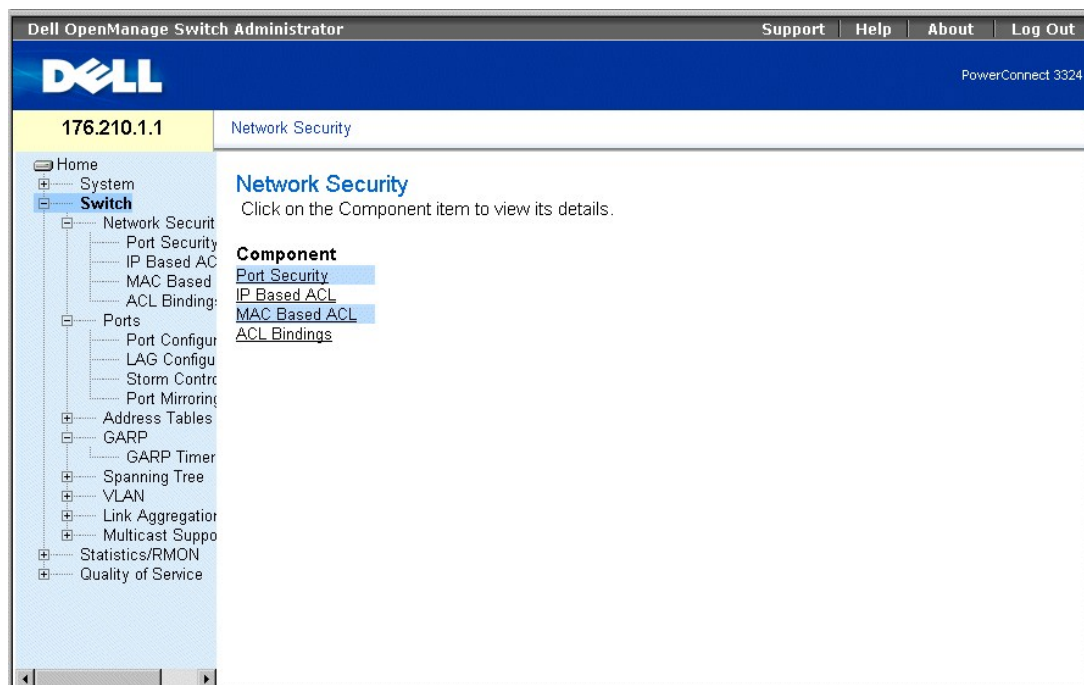

Network Security Page

The **Network Security** page contains links to the following topics:

- 1 [Network Security Overview](#)
- 1 [Configuring Port Security](#)
- 1 [Defining IP-Based ACLs](#)
- 1 [Defining MAC-Based ACLs](#)
- 1 [Binding ACLs](#)

Network Security Overview

Access Control Lists (ACLs) allow network managers to define classification actions and rules for specific ingress ports. ACLs contain multiple classification rules and actions. Each classification rule and action is an Access Control Element (ACE). ACEs are the filters that determine traffic classifications. Packets are matched by the following ACEs:

- 1 Protocol
- 1 Destination Port
- 1 Source IP Address
- 1 Destination IP Address
- 1 Wild Card Masks
- 1 Match DSCP
- 1 Match IP-Precedence
- 1 Source MAC Address
- 1 Destination MAC Address
- 1 VLAN ID

For example, a network administrator may define an ACL rule that states that port number 20 can receive TCP packets; however, if a UDP packet is received, the packet is dropped.

A single ACL can contain more than one ACE. The ACEs within an ACL are applied in a first fit manner. The ACEs are processed sequentially, starting with the

first ACE. When a packet is matched to an ACE classification, the ACE action is taken, and the ACL processing stops. If a match is not found, the packet is dropped as a default action. If several ACLs are to be processed, the default action is applied only after processing all the ACLs. The default drop action forwards all permitted traffic, including management traffic such as Telnet, HTTP, or SNMP, to the switch.

Network managers can define two types of ACLs:

- 1 IP ACL—Applies only to IP packets. All classification fields are related to IP packets.
- 1 MAC ACL—Applies to any packet, including non-IP. Classification fields are based on L2 fields only.

Packets entering an ingress port with an active ACL are:

- 1 Forwarded.
- 1 Discarded and a trap is sent.
- 1 Discarded, a trap is sent, and the ingress port is disabled.

PowerConnect 3324/3348 supports up to 128 ACLs. PowerConnect 3324/3348 supports up to 248 ACEs per FE port and up to 120 ACEs per GE port can be defined.

Configuring Port Security

Network users can be limited to specific ports or LAGs with Locked Ports. Locked Port is restricted to users with specific MAC addresses. Locked ports can only be enabled on static MAC addresses. In addition, the Locked Port security option enables storing a list of MAC addresses in the Configuration file. The MAC address list can be restored after the device has been reset. MAC addresses are learned either dynamically or statically.

Packets arriving at a locked port are either forwarded, dropped, or the packet is dropped, a trap is sent, and the ingress port is disabled. Disabled ports are activated from the **Port Parameters** page. See "[Defining Port Parameters](#)". To open the **Port Security** page:

- 1 Select **Switch > Network Security > Port Security**. The **Port Security** page opens.

The screenshot shows the Dell OpenManage Switch Administrator interface. The top navigation bar includes 'Support', 'Help', 'About', and 'Log Out'. The main header displays the Dell logo and 'PowerConnect 3324'. The left sidebar shows a navigation tree with 'Switch' expanded to 'Network Security' > 'Port Security'. The main content area is titled 'Port Security' and contains the following configuration fields:

Interface	<input checked="" type="radio"/> Port 1 <input type="radio"/> LAG
Current Port Status	Locked
Set Port	Unlocked
Action on Violation	Discard
Trap	Disable
Trap Frequency (1-1000000)	10 (Sec)

Buttons for 'Print', 'Refresh', 'Show All', and 'Apply Changes' are also visible.

Port Security Page

The **Port Security** page contains the following fields:

- 1 **Interface**—Indicates the selected interface type on which locked port is enabled.
 - o **Port**—Indicates the selected interface type is a port.
 - o **LAG**—Indicates the selected interface type is a stack member.
- 1 **Current Port Status**—Indicates the current port status.
- 1 **Set Port**—Indicates that the port is either locked or unlocked. The possible field values are:
 - o **Unlocked**—Unlocks Port. This is the default value.
 - o **Locked**—Locks Port.
- 1 **Action on Violation**—Indicates the action to be applied to packets arriving on a locked port. The possible field values are:
 - o **Forward**—Forwards the packets from an unknown source; however, the MAC address is not learned.
 - o **Discard**—Discards the packets from any unlearned source. This is the default value.
 - o **Shutdown**—Discards the packet from any unlearned source and locks the port. Ports remain locked until activated or the device is reset.
- 1 **Trap**—Enables sending a trap. The possible field values are:
 - o **Enable**—Enables traps being sent when a packet is received on a locked port.
 - o **Disable**—Disables traps being sent when a packet is received on a locked port. This is the default value.
- 1 **Trap Frequency (1-1000000)**—Indicates the amount of time (in seconds) between traps. This field only applies to locked ports. The default value is 10 seconds.

Defining a Locked Port:

1. Open the **Port Security** page.
2. Select an interface type and number.
3. Define the **Set Port**, **Action on Violation**, and **Trap** fields.
4. Click **Apply Changes**. The locked port is added to the **Port Security Table**, and the device is updated.

Displaying the Locked Port Table:

1. Open the **Port Security** page.
2. Click **Show All**. The **Port Security Table** page opens. The fields in the **Port Security Table** are the same as the fields in the **Port Security** page. Locked Ports can also be defined from the **Locked Ports Table** as well as the **Port Security** page.

Port Security Table

Unit No.

Copy Parameters from Port LAG

Port	Locked Port Status	Set Locked Port	Action	Trap	Trap Frequency	Copy to Select All
1	Enable	Enable	Forward	Enable	<input type="text"/>	<input type="checkbox"/>
1	Enable	Enable	Forward	Enable	<input type="text"/>	<input type="checkbox"/>

Port Security Table Page

In addition to the fields displayed in the [Port Security Page](#), the **Port Security Table** page contains the following additional field:

- 1 **Unit No.**—Indicates the unit number for which the port security information is displayed.

Configuring Locked Port Security with CLI Commands

The following table summarizes the equivalent CLI commands for configuring Locked Port security as displayed in the [Port Security Page](#).

CLI Command	Description
<code>shutdown</code>	Disables interfaces.
<code>set interface active { ethernet <i>interface</i> port-channel <i>port-channel-number</i> }</code>	Reactivates an interface that is shutdown due to port security reasons.
<code>port security <options> trap <i>frequency</i></code>	Locks learning of new addresses on an interface.
<code>show ports security</code>	Displays port lock status.

The following is an example of the CLI commands:

```
From 18.1.16 Console # show ports security
```

```
Port Action Trap Frequency Counter
```

```
-----
```

```
5/7 Discard Enable 100 88
```

```
7/8 Discard Disable
```

Defining IP-Based ACLs

The **Add ACE to IP Based ACL** page allows network administrators to define IP-based Access Control Lists (ACLs) and Access Control Entries (ACEs). ACEs act as filters to match packets to forwarding criteria. To open the **Add ACE to IP Based ACL** page:

- 1 Select **Switch > Network Security > IP based ACL**. The **Add ACE to IP Based ACL** page opens.

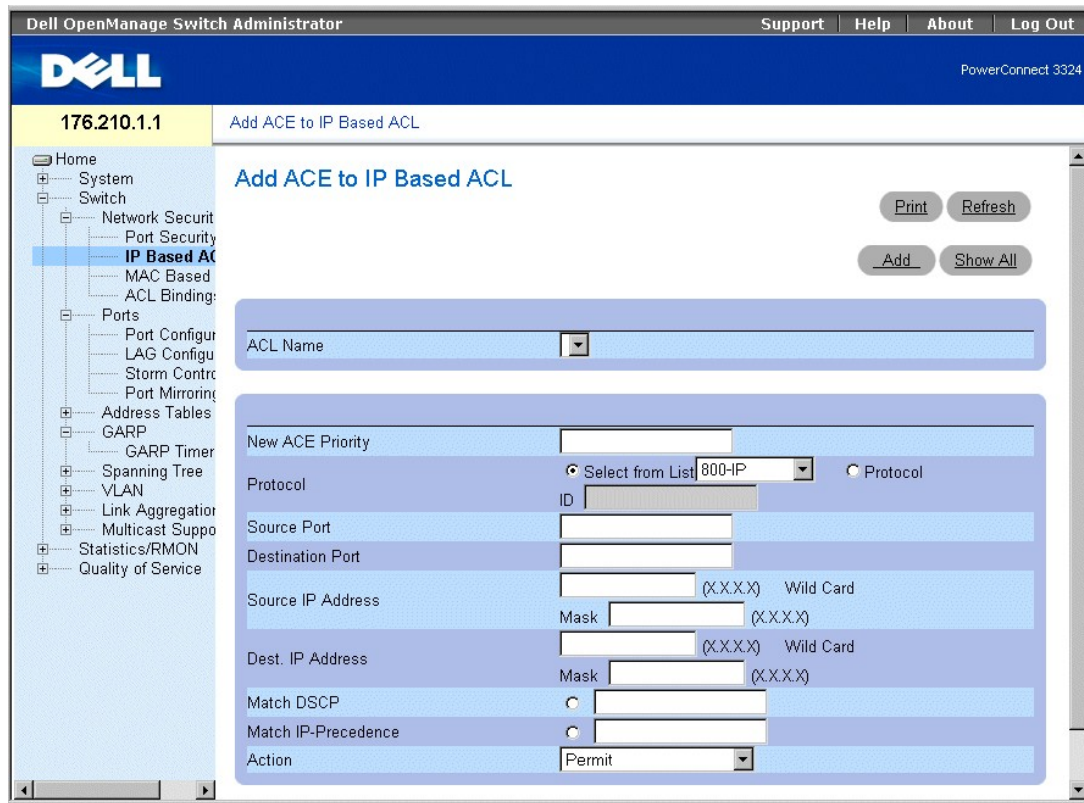

Add ACE to IP Based ACL Page

The **Add ACE to IP Based ACL** page contains the following fields:

- 1 **ACL Name**—Contains a list of user-defined ACLs.
- 1 **New ACE Priority**—Defines the ACE priority. ACEs are checked on the first fit basis. The ACE priority defines the ACE order in the ACL list.
- 1 **Protocol**—Enables creating an ACE based on a specific protocol.
- 1 **Source Port**—Indicates the source port that is matched packets. Enabled only when TCP or UDP are selected in the Protocol list.
- 1 **Destination Port**—Indicates the destination port that is matched packets. Enabled only when TCP or UDP are selected in the Protocol list.
- 1 **Source IP Address**—Matches the source IP address to which packets are addressed to the ACE.
- 1 **Wild Card Mask**—Indicates the source IP Address wild card mask. Wild cards are used to mask all or part of a source IP Address. Wild card masks specify which bits are used and which bits are ignored. A wild card mask of 255.255.255.255 indicates that no bit is important. A wildcard of 00.00.00.00 indicates that all bits are important. For example, if the source IP address 149.36.184.198 and the wildcard mask is 255.36.184.00, the first two bits of the IP address are ignored, while the last two bits are used.
- 1 **Dest. IP Address**—Matches the destination IP address to which packets are addressed to the ACE.
- 1 **Wild Card Mask**—Indicates the destination IP Address wild card mask. Wild cards are used to mask all or part of a destination IP Address. Wild card masks specify which bits are used and which bits are ignored. A wild card mask of 255.255.255.255 indicates that no bit is important. A wildcard of 00.00.00.00 indicates that all bits are important. For example, if the destination IP address 149.36.184.198 and the wildcard mask is 255.36.184.00, the first two bits of the IP address are used, while the last two bits are ignored.
- 1 **Match DSCP**—Matches the packet DSCP value to the ACE. Either the DSCP value or the IP Precedence value is used to match packets to ACEs.
- 1 **Match IP-Precedence**—Matches the packet IP Precedence value to the ACE. Either the DSCP value or the IP Precedence value is used to match packets to ACEs.
- 1 **Action**—Indicates the ACE forwarding action. The possible field values are:
 - o **Permit**—Forwards packets which meet the ACE criteria.
 - o **Deny**—Drops packets which meet the ACE criteria.
 - o **Deny and Disable Port**—Drops packet that meet the ACE criteria, and disables the port to which the packet was addressed. Ports are reactivated from the Port Configuration; see ["Defining Port Parameters"](#).

Adding IP-based ACLs:

1. Open the **Add ACE to IP Based ACL** page.

2. Click **Add**. The **Add ACE to IP Based ACL** page opens.

Refresh

Add IP Based ACL

ACL Name

New ACE Priority

Protocol Select from List 800-IP Protocol ID

Source Port

Destination Port

Source IP Address (X.X.X.X) Wild Card Mask (X.X.X.X)

Dest. IP Address (X.X.X.X) Wild Card Mask (X.X.X.X)

Match DSCP

Match IP-Precedence

Action

Apply Changes

Add IP Based ACL Page

3. Define the **ACL Name**, **New Ace Priority**, **Protocol**, **Source and Destination Port**, **Source and Destination IP Address**, **Match DSCP** or **Match IP Precedence**, and **Action** fields.
4. Click **Apply Changes**. The IP-based ACLs are defined. If a new ACE priority was defined, it is added to the new ACL.

Assigning ACEs to a IP-based ACL:

1. Open the **Add ACE to IP Based ACL** page.
2. Select an ACL in the **ACL Name** drop-down list.
3. Define the **New ACE Priority** field.
4. Define the **ACE No.**, **Protocol**, **Source and Destination Port**, **Source and Destination IP Address**, **Match DSCP** or **Match IP Precedence**, and/or **Action** fields.
5. Click **Apply Changes**. The ACE is assigned to the IP-based ACL.

Displaying ACL-specific ACEs:

1. Open the **Add ACE to IP Based ACL** page.
2. Click **Show All**. The **ACEs Associated with IP-ACL** page opens.

ACEs Associated with IP ACL

ACL Name

Remove ACL

Priority	Protocol	Source Port	Destination Port	Source IP Address	Destination IP Address	Match DSCP	Match IP.Precedence	Action	Remove
<input type="text"/>	<input type="text"/>	<input type="text"/>	<input type="text"/>	<input type="text"/>	<input type="text"/>	<input type="text"/>	<input type="text"/>	Permit <input type="text"/>	<input type="checkbox"/>

ACEs Associated with IP-ACL

Modifying an IP-based ACE:

1. Open the **Add ACE to IP Based ACL** page.
2. Click **Show All**. The **ACEs Associated with IP-ACL** page opens.
3. Modify the **ACL Name**, **New Ace Priority**, **Protocol**, **Source and Destination Port**, **Source and Destination IP Address**, **Match DSCP** or **Match IP Precedence**, and **Action** fields.
4. Click **Apply Changes**. The IP-based ACEs is modified, and the device is updated.

Removing ACLs:

1. Open the **Add ACE to IP Based ACL** page.
2. Click **Show All**. The **ACEs Associated with IP-ACL** page opens.
3. Select an ACL.
4. Check the **Remove ACL** check box.
5. Click **Apply Changes**. The IP-based ACL is removed, and the device is updated.

Removing ACEs:

1. Open the **Add ACE to IP Based ACL** page.
2. Click **Show All**. The **ACEs Associated with IP-ACL** page opens.
3. Select an ACE.
4. Check the **Remove** check box.
5. Click **Apply Changes**. The IP-based ACE is removed, and the device is updated.

Assigning IP-based ACEs to ACLs Using the CLI Commands

The following table summarizes the equivalent CLI commands for assigning IP-based ACEs to ACLs as displayed in the **Add ACE to IP Based ACL** page.

CLI Command	Description
<code>ip access-list name</code>	Enters to IP-Access list configuration mode.
<code>permit {any protocol} {any {source source-wildcard}} {any {destination destination-wildcard}} [dscp dscp number ip-precedence ip-precedence]</code>	Allows traffic if the conditions defined in the permit statement are matched.
<code>deny [disable-port] {any protocol} {any {source source-wildcard}} {any {destination destination-wildcard}} [dscp dscp number ip-precedence ip-precedence]</code>	Denies traffic if the conditions defined in the deny statement are matched.

The following is an example of the CLI commands:

```
Permit 00:00:00:11:11:11 0:0:0:0:0:0 any VLAN 4
```

```
deny 00:00:00:11:11:11 0:0:0:0:0:0 any VLAN 4
```

Defining MAC-Based ACLs

The **Add ACE to MAC Based ACL** page allows network administrators to define MAC-based **Access Control Entry (ACE)** and **Access Control Lists (ACLs)**. ACEs act as filters to match packets to forwarding criteria. To open the **Add ACE to MAC Based ACL**:

1. Select **Switch > Network Security > MAC Based ACL**. The **Add ACE to MAC Based ACL** page opens.

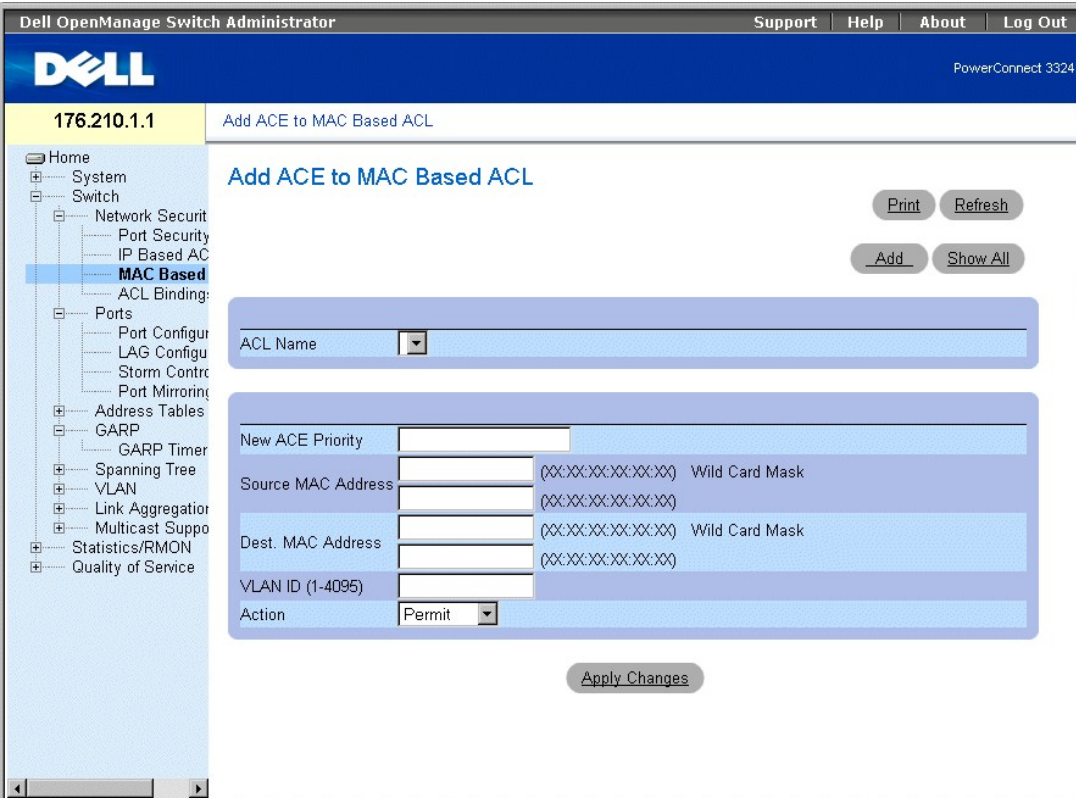

Add ACE to MAC Based ACL Page

The **Add ACE to MAC Based ACL** page contains the following fields:

1. **ACL Name**—Contains a list of user-defined ACLs.
1. **New ACE Priority**—Enables creating a new ACE and indicates the ACE priority.
1. **Source MAC Address**—Matches the source MAC address from which packets are addressed to the ACE.
1. **Wild Card Mask**—Indicates the source MAC Address wild card mask. Wild cards are used to mask all or part of a source MAC address. Wild card masks specify which bits are used and which are ignored. A wild card mask of FF:FF:FF:FF:FF:FF indicates that no bit is important. A wildcard of 00:00:00:00:00:00 indicates that all bits are important. For example, if the source MAC address is E0:3B:4A:C2:CA:E2 and the wildcard mask is 00:3B:4A:C2:CA:FF, the first two bits of the MAC are used, while the last two bits are ignored.
1. **Destination MAC Address**—Matches the destination MAC address to which packets are addressed to the ACE.
1. **Wild Card Mask**—Indicates the destination MAC Address wild card mask. Wild cards are used to mask all or part of a destination MAC address. Wild card masks specify which bits are used and which are ignored. A wild card mask of FF:FF:FF:FF:FF:FF indicates that no bit is important. A wild card mask of 00:00:00:00:00:00 indicates that all bits are important. For example, if the destination MAC address is E0:3B:4A:C2:CA:E2 and the wildcard mask is 00:3B:4A:C2:CA:FF, the first two bits of the MAC are used, while the last two bits are ignored.
1. **VLAN ID**—Matches the packet's VLAN ID to the ACE.
1. **Action**—Indicates the ACE forwarding action. The possible field values are:
 - o **Permit**—Forwards packets which meet the ACE criteria.
 - o **Deny**—Drops packets which meet the ACE criteria.
 - o **Shutdown**—Drops packet that meet the ACE criteria, and disables the port to which the packet was addressed. Ports are reactivated from the Port Configuration, see ["Defining Port Parameters"](#).

Adding a MAC-based ACL:

1. Open the **Add ACE to MAC Based ACL** page.
2. Click **Add**. The **Add MAC Based ACL** page opens.

Refresh

Add MAC Based ACL

ACL Name	<input type="text"/>
New ACE	<input type="text"/>
Priority	<input type="checkbox"/>
Source MAC Address	<input type="text"/> (XX:XX:XX:XX:XX:XX) Wild Card Mask <input type="text"/> (XX:XX:XX:XX:XX:XX)
Dest. MAC Address	<input type="text"/> (XX:XX:XX:XX:XX:XX) Wild Card Mask <input type="text"/> (XX:XX:XX:XX:XX:XX)
VLAN ID (1-4095)	<input type="text"/>
Action	Permit <input type="text"/>

ACEs Associated with Mac-Based ACLs

3. Define the **ACL Name**, **Source and Destination Address**, and **Action** fields.
4. Click **Apply Changes**. The MAC-based ACL is defined and the device is updated.

Assigning ACEs to a MAC-based ACL:

1. Open the **Add ACE to MAC Based ACL** page.
2. Select an ACL in the **ACL Name** drop-down list.
3. Define the **New ACE Priority** field.
4. Define the **ACL Name**, **VLAN ID**, **Source and Destination Address**, and **Action** fields.
5. Click **Apply Changes**. The ACE is assigned to the MAC based ACL.

Displaying ACL-specific ACEs:

1. Open the **Add ACE to MAC Based ACL** page.
2. Click **Show All**. The **ACEs Associated with MAC ACL** page opens.

ACEs Associated with MAC ACL

ACL Name	<input type="text"/>				
Remove ACL	<input type="checkbox"/>				
Priority	Action	Source Address	Destination Address	VLAN ID	Remove
<input type="text"/>	Permit <input type="text"/>				<input type="checkbox"/>

ACEs Associated with MAC ACL

Modifying a MAC-based ACE:

1. Open the **Add ACE to MAC Based ACL** page.
2. Click **Show All**. The **ACEs Associated with MAC ACL** page opens.
3. Modify the **ACL Name**, **Source and Destination Address**, and **Action** fields.
4. Click **Apply Changes**. The MAC-based ACEs is modified, and the device is updated.

Removing ACLs:

1. Open the **Add ACE to MAC Based ACL** page.
2. Click **Show All**. The **ACEs Associated with MAC ACL** page opens.
3. Select an ACL.
4. Check the **Remove ACL** check box.
5. Click **Apply Changes**. The MAC-based ACL is removed, and the device is updated.

Removing ACEs:

1. Open the **Add ACE to MAC Based ACL** page .
2. Click **Show All**.The **ACEs Associated with MAC ACL** page opens.
3. Select an ACE.
4. Check the **Remove** check box.
5. Click **Apply Changes**. The MAC-based ACE is removed, and the device is updated.

Assigning MAC-Based ACEs to ACLs Using the CLI Commands

The following is an example. Station A is connected to port 5, and Station B is connected to port 9. Station A has the MAC address 00-0B-CD-35-6A-00 (ip address: 10.0.0.1 255.255.255.0). Station B has the MAC address 00-06-6B-C7-A1-D8 (ip address: 10.0.0.2 255.255.255.0).

To implement a MAC ACL on port 5 to allow all traffic to move from Station A to Station B, enter the following CLI commands

```
permit source mac address destination mac address

permit 00-0B-CD-35-6A-00 0.0.0.0.0.0 00-06-6B-C7-A1-D8 0.0.0.0.0.0
```

All traffic that matches the ACL passes the traffic, and all other traffic is denied. (There is an additional promiscuous `deny all` entered at the end of the ACL.)

For the above example, Station A is trying to send ICMP ECHO to Station B. The ICMP fails, even if it is permitted by the MAC ACL. The problem is that Station A is trying to send the ICMP ECHO to Station B, but it does not have an entry in the ARP table. Station A tries to get the MAC address of Station B by ARP request that is the broadcast frame with the source MAC of Station A (00-0B-CD-35-6A-00) and destination broadcast (FF.FF.FF.FF.FF.FF). This frame is silently dropped because it does not match the MAC ACL that was set up on port 5.

To solve this issue, the user has to enter the additional `permit` line that allows the broadcast frame:

```
permit 00-0B-CD-35-6A-00 0.0.0.0.0.0 FF.FF.FF.FF.FF.FF 0.0.0.0.0.0
```



NOTE: Even though a user intends to permit traffic from MAC address A to MAC address B, the user cannot succeed with simple traffic like ICMP, because the additional broadcast is not taken into consideration.

The following table summarizes the equivalent CLI commands for assigning MAC based ACEs to ACLs as displayed in the **Add ACE to MAC Based ACL** page.

CLI Command	Description
<code>mac access-list name</code>	Creates Layer 2 MAC ACLs, and enters to MAC-Access list configuration mode.
<code>permit {any {host source source-wildcard} any {destination destination-wildcard}} [vlan vlan-id]</code>	Allows traffic if the conditions defined in the permit statement are matched.
<code>deny [disable-port] {any {source source-wildcard} any {destination destination-wildcard}} [vlan vlan-id]</code>	Allows traffic if the conditions defined in the permit statement are matched.

The following is an example of the CLI commands:

```
Console (config)# mac access-list dell
```

```
Console (config-mac-a1)# permit 6.6.6.6.6 0.0.0.0.0.0 any vlan 4
```

```
Console (config-mac-a1)# deny 6.6.6.6.6 0.0.255.255.255.255
```

Binding ACLs

The **ACL Bindings** page allows network managers to assign ACL Lists to interfaces. To open the **ACL Bindings** page:

- 1 Select **Switch > Network Security > ACL Bindings**. The **ACL Bindings** page opens.

 **NOTE:** ACLs have no effect unless attached to an interface.

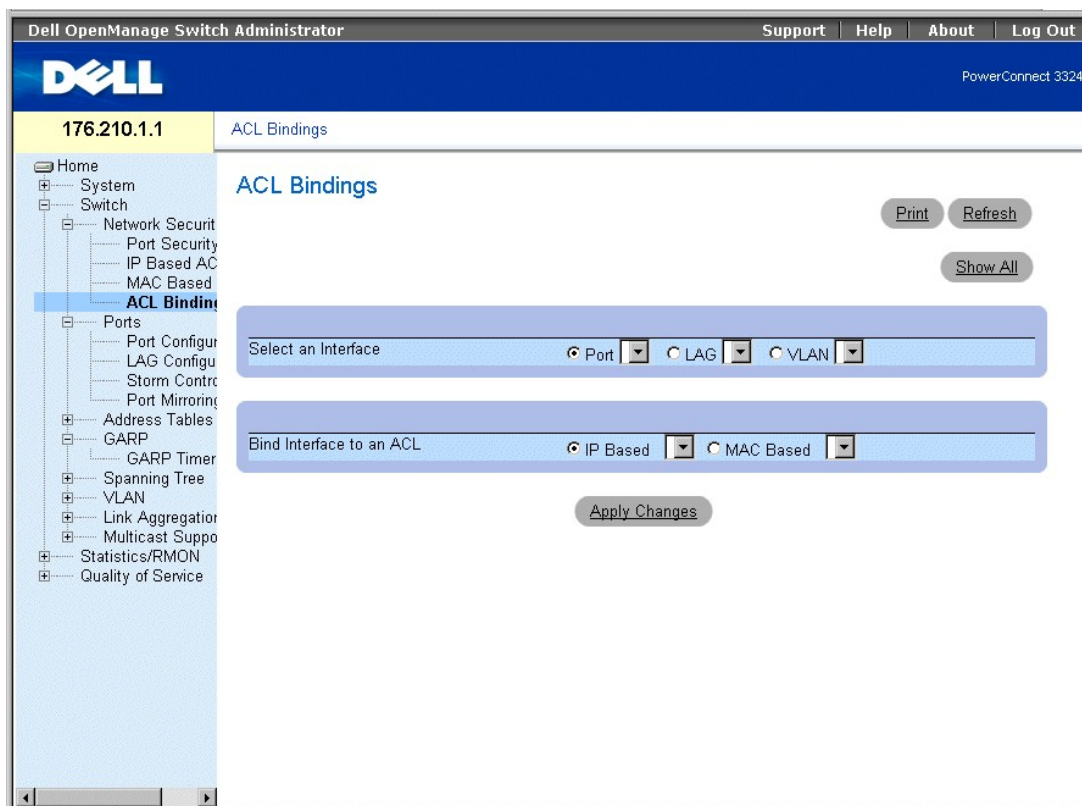

ACL Bindings Page

The **ACL Bindings** page contains the following fields:

- 1 **Select an Interface**—Indicates the interface and interface type to which the ACL is attached. The possible field values are:
 - o **Port**—Indicates the port number to which the ACL is attached.
 - o **LAG**—Indicates the LAG to which the ACL is attached.
 - o **VLAN**—Indicates the VLAN to which the ACL is attached.
- 1 **Bind Interface to ACL**—Indicates the ACL name to which incoming packets are matched. Packets can be matched to either IP-based ACLs or MAC Address based ACLs. The possible field values are:

- o **IP Based**—Indicates that incoming packets are matched to IP-based ACLs.
- o **MAC Based**—Indicates that incoming packets are matched to MAC based ACLs.

Assigning an ACL to an Interface:

1. Open the **ACL Bindings** page.
2. Select the ACL type in the **Select ACL** fields.
3. Define the interface to which the ACL is attached in the **Attach ACL to an Interface** field.
4. Click **Apply Changes**. The ACL is attached to the interface.

Assigning ACL Membership Using the CLI Commands

The following table summarizes the equivalent CLI commands for assigning ACL membership as displayed in the **ACL Bindings** page.

CLI Command	Description
<code>class-map <i>class-map-name</i> [match-all match-any]</code>	Creates class maps and enters the class-map configuration mode.
<code>match access-group ACL <i>name</i></code>	Defines the match criterion to classify traffic.
<code>show class-map [<i>class-map-name</i>]</code>	Displays all the class maps configured on the device.

The following is an example of the CLI commands:

```
Console (config)# class-map class1 match-any
```

```
Console (config-cmap)# match access-group dell
```

```
Console (config-cmap)# exit
```

```
Console (config)# exit
```

```
Console # exit
```

```
Console> show class-map class1
```

```
Class Map match-any class1 (id4)
```

Configuring Ports

This section provides an explanation and instruction for configuring port functionality including advanced features, such as Storm Control and Port Mirroring. To open the **Ports** page:

1. Select **Switch > Ports**. The **Ports** page opens.

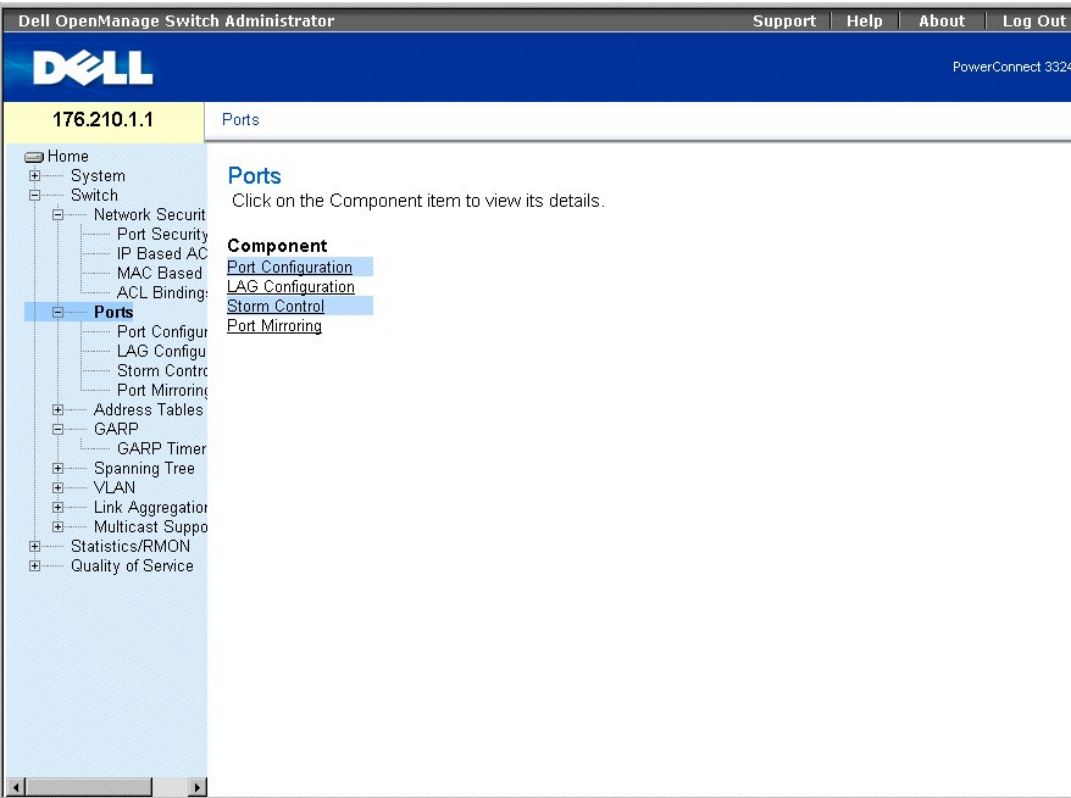

Ports Page

This section includes the following topics:

- 1 [Defining Port Parameters](#)
- 1 [Defining LAG Parameters](#)
- 1 [Enabling Storm Control](#)
- 1 [Defining Port Mirroring Sessions](#)

Defining Port Parameters

The **Port Configuration** page allows network administrators to define port parameters. To open the **Port Configuration** page:

- 1 Click **Switch > Ports > Port Configuration** in the Tree View. The **Port Configuration** page opens.

Dell OpenManage Switch Administrator Support Help About Log Out

PowerConnect 3324

176.210.1.1 Port Configuration

- Home
- System
- Switch
 - Network Security
 - Port Security
 - IP Based AC
 - MAC Based
 - ACL Binding
 - Ports**
 - Port Configur
 - LAG Configu
 - Storm Contr
 - Port Mirring
 - Address Tables
 - GARP
 - GARP Timer
 - Spanning Tree
 - VLAN
 - Link Aggregat
 - Multicast Suppo
 - Statistics/RMON
 - Quality of Service

Port Configuration

Print Refresh
Show All

Port	1
Description	
Port Type	
Admin Status	Up
Current Port Status	Up
Re-Activate Suspended Port	<input type="checkbox"/>
Operational Status	Suspended
Admin Speed	10M
Current Port Speed	100M
Admin Duplex	Full
Current Duplex Mode	Full
Auto Negotiation	Enable
Back Pressure	Enable
Flow Control	Enable
MDI/MDIX	Auto
Current MDI/MDIX	
LAG	

Port Configuration

The **Port Configuration** page contains the following fields:

- 1 **Port**—Specifies the port number.
- 1 **Description**—Provides a brief interface description, for example Ethernet.
- 1 **Port Type**—Indicates the port type. The possible field values are:
 - o Ethernet
 - o Fast Ethernet
 - o GE
- 1 **Admin Status**—Controls the selected port traffic. By default, this parameter is set to **Enable**. The possible field values are:
 - o **Up**—Enables traffic forwarding through the port.
 - o **Down**—Disables traffic forwarding through the port.
- 1 **Current Port Status**—Specifies the port operational status. The possible field values are:
 - o **Up**—Indicates the port is currently operating.
 - o **Down**—Indicates the port is currently non-operational.
- 1 **Re-Activate Suspended Port**—Reactivates a port if the port has been disabled through the **Locked Port** or **ACL** security options.
- 1 **Operational Status**—Indicates the port operational status.
- 1 **Admin Speed**—Specifies at what rate the port is running. This value can be specified only if the port is disabled. The possible field values are:
 - o 10M
 - o 100M
 - o 1000M
- 1 **Current Port Speed**—Specifies the synchronized port speed in bps. The possible field values are:
 - o **10M**
 - o **100M**
 - o **1000M**

- 1 **Admin Duplex**—Specifies the synchronized port duplex mode in bps. When Admin Duplex is set to full, Head-of-Line blocking is operational on the selected port. The possible fields values are:
 - o **Full**—The interface supports transmission between the device and the client in both directions simultaneously. This is the default value.
 - o **Half**—The interface supports transmission between the device and the client in only one direction at a time.
- 1 **Current Duplex Mode**— Specifies the synchronized port duplex mode. The possible field values are:
 - o **Full**
 - o **Half**
- 1 **Auto Negotiation**—Enables Auto Negotiation on the device. Auto-negotiation is a protocol between two link partners that enables a port to advertise its transmission rate, duplex mode, and flow control abilities to its partner. The possible field values are:
 - o **Enable**—Enables auto negotiation on the port.
 - o **Disable**—Disables auto negotiation on the port. This is the default value.
 - o **Current Auto Negotiation**—Indicates the Auto Negotiation operational status.
- 1 **Back Pressure**—Enables Back Pressure mode on the device. Back Pressure mode is used with Half Duplex mode to disable ports from receiving messages. When Back Pressure is enabled, Head-of-Line blocking is not operational, even if it is set to enable.
 - 1 The possible field values are:
 - o **Enable**—Enables back pressure on the port.
 - o **Disable**—Disable back pressure on the port. This is the default value.
 - o **Current Back Pressure**—Indicates the back pressure operational status.
- 1 **Flow Control**—Indicates if Flow Control is enabled on the port. Flow control is enabled if the device is in Duplex mode. In addition, when Flow Control is enabled, Head-of-Line is disabled on the selected port. When Flow Control is enabled, Head-of-Line blocking is not operational, even if it is set to enable. The possible field values are:
 - o **Enable**—Indicates that Flow Control is enabled on the device.
 - o **Disable**—Indicates that Flow Control is disabled on the device. This is the default value.
 - o **Current Flow Control**—Indicates the Flow Control operational status.
 - o **Auto-negotiation**—Enables auto negotiation of Flow Control on the port.
 - o **Tx Only**—Enables auto negotiation for egress ports.
 - o **Rx Only** —Enables auto negotiation for ingress ports.
- 1 **MDI/MDIX**—Allows the device to decipher between crossed and uncrossed cables. Hubs and switches are deliberately wired the opposite way end stations are wired, so that when a hub or switch is connected to an end station, a straight through Ethernet cable can be used, and the pairs match up properly. When two hubs/switches are connected to each other, or two end stations are connected to each other, a crossover cable is used to make sure that the correct pairs are connected. The standard cable wirings are:
 - o Media Dependent Interface with Crossover (MDIX) for hubs and switches
 - o Media Dependent Interface (MDI) for end stations

 **NOTE:** Auto MDIX does not operate on FE ports when auto negotiation is disabled.

The following table describes the parameter combination settings required to configure ports. These settings ensure that configuration functionalities are maintained.

	Auto Negotiation	
	Enabled	Disabled
Auto	legal	illegal
MDI	legal	legal
MDIX	legal	legal

- 1 **Current MDI/MDIX**—Indicates the MDIX operational status. The possible field values are:
 - o **MDI**
 - o **MDIX**
 - o **Auto**—Indicates that the value is set automatically.
- 1 **LAG**—Specifies if the port is part of a LAG.

Defining Port Parameters:

1. Open the **Port Configuration** page.
2. Select a port in the **Port** field.
3. Define the **Description**, **Admin Status**, **Admin Speed**, **Admin Duplex**, **Auto Negotiation**, **Back Pressure**, **Admin Auto MDIX** and/or **Admin Flow Control** fields.
4. Click **Apply Changes**. The port parameters are saved to the device.

Modifying Port Parameters:

1. Open the **Port Configuration** page.
2. Select a port in the **Port** field.
3. Modify the **Description**, **Admin Status**, **Admin Speed**, **Admin Duplex**, **Auto Negotiation**, **Back Pressure**, **Admin Auto MDIX** and/or **Admin Flow Control** fields.
4. Click **Apply Changes**. The port parameters are saved to the device.

Displaying the Port Configuration Table:

1. Open the **Port Configuration** page.
2. Click **Show All**. The **Port Configuration Table** opens.

Unit Number

Port	Port Type	Port Status	Port Speed	Duplex Mode	Auto Negotiation	Back Pressure	Flow Control	Auto MDIX	LAG
1	Ethernet	Up Up	100M 100M	Full Full	Enable Enable	Enable Enable	Enable On	MDI Auto	

Ports Configuration Table

In addition to the **Port Configuration** page fields, the **Port Configuration Table** also displays the following field:

1. **Unit Number**—Indicates the stacking unit number for which the port information is displayed.

Configuring Ports with CLI Commands

The following examples describe how to set a port to MDIX or MDI mode. To set a port to MDIX mode, enter the following at the system prompt:

```
console(config-if)# mdix on
```

The following message displays:

```
console # show inter config ethernet 1/e1

Flow Admin Back MdiX
Port Type Duplex Speed Neg Control State Pressure Mode
.....

1/e1 100M-Copper Enabled Off Up Disabled On
```

To set a port to MDI mode, enter the following at the system prompt:

```
console(config)# inter eth 1/e1
```

```
console(config-if)# no mdix
```

The following message displays:

```
console # show inter config ethernet 1/e1
```

```
Flow Admin Back Mdx  
Port Type Duplex Speed Neg Control State Pressure Mode
```

```
.....
```

```
1/e1 100M-Copper Enabled Off Up Disabled Off
```

The following table summarizes the equivalent CLI commands for configuring ports as displayed in the **Port Configuration**.

CLI Command	Description
<code>interface ethernet <i>interface</i></code>	Enters the interface configuration mode to configure an ethernet type interface.
<code>description <i>string</i></code>	Adds a description to an interface configuration.
<code>shutdown</code>	Disables interfaces that are part of the currently set context.
<code>set interface active {ethernet <i>interface</i> port-channel <i>port-channel-number</i>}</code>	Reactivates an interface that is shut down due to security reasons.
<code>speed {10 100 1000}</code>	Configures the speed of a given ethernet interface when not using auto negotiation.
<code>duplex {half full}</code>	Configures the full/half duplex operation of a given ethernet interface when not using auto negotiation.
<code>negotiation</code>	Enables auto negotiation operation for the speed and duplex parameters of a given interface.
<code>back-pressure</code>	Enables Back Pressure on a given interface.
<code>flowcontrol {auto on off rx tx}</code>	Configures the Flow Control on a given interface.
<code>mdix {on auto}</code>	Enables automatic crossover on a given interface or Port-channel.
<code>show interfaces configuration [ethernet <i>interface</i> port-channel <i>port-channel-number</i>]</code>	Displays the configuration for all configured interfaces.
<code>show interfaces status [ethernet <i>interface</i> port-channel <i>port-channel-number</i>]</code>	Displays the status for all configured interfaces.
<code>show interfaces description [ethernet <i>interface</i> port-channel <i>port-channel-number</i>]</code>	Displays the description for all configured interfaces.

The following is an example of the CLI commands:

```
Console (config)# interface ethernet 1/e5
```

```
Console (config-if)#
```

```
Console (config-if)# description RD SW#3
```

```
Console (config-if)# shutdown
```

```
Console (config-if)# no shutdown
```

```
Console (config-if)# speed 100
```

Console (config-if)# **duplex full**

Console (config-if)# **negotiation**

Console (config-if)# **back-pressure**

Console (config-if)# **flowcontrol on**

Console (config-if)# **mdix auto**

Console (config-if)# **exit**

Console (config)# **exit**

Console# **show interfaces configuration**

Port Type Duplex Speed Neg Flow Back MDIX Admin

Cont Pres Mode State

1/e1 1g-combo-c Full 1000 Auto On Enable Auto Up

2/e1 100-copper Full 1000 Off Off Disable off Up

2/e2 1g-Fiber Full 1000 Off Off Disable on Up

Neg : Negotiation

Flow Cont: Flow Control

Back Pres: Back Pressure

Console# **show interfaces status**

Port Port Duplex Speed Neg Flow Back MDI Link

Cont Pres Mode State

2/e1 100-copper Full 1000 off Off Disable Off Down*

Legend

Neg : Negotiation

Flow Cont: Flow Control

Back Pres: Back Pressure

*: The interface was suspended by the system.

Router# **show interfaces description**

Port Description

1/e1 Port that should be used for management only

2/e1

2/e2

Port Channel Description

1 dell

2 projects

Defining LAG Parameters

The **LAG Configuration** page allows network managers to configure parameter for configured LAGs. PowerConnect 3324/3348 supports up to 8 ports per LAG, and 6 LAGs per system. The system provides 6 permanent LAGs. For information about Link Aggregated Groups (LAGs) and assigning ports to LAGs, see "[Aggregating Ports](#)".

To open the **LAG Configuration** page:

NOTE: If port configuration is modified while the port is a LAG member, the configuration change is only effective after the port is removed from the LAG.

- 1 Click **Switch > Ports > LAG Configuration** in the Tree View. The **LAG Configuration** page displays.

The screenshot shows the Dell OpenManage Switch Administrator interface. The top navigation bar includes 'Support', 'Help', 'About', and 'Log Out'. The main header displays the IP address '176.210.1.1' and the page title 'LAG Configuration'. On the left, a tree view shows the navigation structure, with 'LAG Config' highlighted under the 'Ports' section. The main content area is titled 'LAG Configuration' and contains a table of configuration parameters for LAG 1. The parameters and their values are: LAG (1), Description (empty), LAG Type (empty), Admin Status (Up), Current LAG Status (Up), Admin Auto Negotiation (Enable), Current Auto Negotiation (Enable), Admin Speed (10M), Current LAG Speed (10M), Admin Flow Control (On), and Current Flow Control (On). Buttons for 'Print', 'Refresh', 'Show All', and 'Apply Changes' are located around the configuration table.

LAG Configuration Page

The **LAG Configuration** page contains the following fields:

- 1 **LAG**—Indicates the LAG number.
- 1 **Description**—Provides a user-defined LAG description.
- 1 **LAG Type**—Indicates the LAG maximum speed capacity.
- 1 **Admin Status**—Controls the traffic from the selected LAG. By default, this parameter is set to **Up**. The possible field values are:
 - o **Up**—Enables traffic forwarding through the LAG.
 - o **Down**—Disables traffic forwarding through the LAG.
- 1 **Current LAG Status**—Specifies the LAG status. The possible field values are:
 - o **Up**—Indicates the LAG is currently operating.
 - o **Down**—Indicates the LAG is currently non-operational.
- 1 **Admin Auto Negotiation**—Enables Auto Negotiation on the LAG. Auto-negotiation is a protocol between two link partners that enables a LAG to advertise its transmission rate, duplex mode, and flow control (the flow control default is disabled) abilities to its partner. The possible field values are:
 - o **Enable**—Enables auto negotiation on the LAG.
 - o **Disable**—Disables auto negotiation on the LAG.
- 1 **Current Auto Negotiation**—Indicates the current Auto Negotiation setting. The possible field values are:
 - o **Enable**
 - o **Disable**

- 1 **Admin Speed**—Indicates the speed at which the LAG is operating. This value can be entered only if the LAG is disabled. The possible field values are:
 - o **10M**
 - o **100M**
 - o **1000M**
- 1 **Current LAG Speed**—Specifies the synchronized LAG speed in bps. The possible field values are:
 - o **10M**
 - o **100M**
 - o **1000M**
- 1 **Current Duplex Mode**—Specifies the LAG conversation type. The current field values are:
 - o **Full**—The interface supports transmission between the device and the client in both directions simultaneously.
 - o **Half**—The interface supports transmission between the device and the client in only one direction at a time.
- 1 **Admin Current Duplex Mode**—Specifies the LAG conversation type. The current field values are:
 - o **Full**—The interface supports transmission between the device and the client in both directions simultaneously.
 - o **Half**—The interface supports transmission between the device and the client in only one direction at a time.
- 1 **Flow Control**—Indicates if Flow Control is enabled on the LAG. The possible values are:
 - o **Off**—Disables Flow Control on the LAG. This is the default value.
 - o **On**—Enables Flow Control on the LAG.
 - o **Auto-negotiation**—Enables auto negotiation of Flow Control on the LAG.
- 1 **Current Flow Control**—Indicates the current Flow Control setting. The possible values are:
 - o **Off**
 - o **On**
 - o **Auto-negotiation**

Defining LAG parameters:

1. Open the **LAG Configuration** page.
2. Select a LAG in the **LAG** field.
3. Define the **Description**, **Admin Status**, **Port Speed**, **Admin Auto Negotiation**, **Admin Speed**, and/or **Admin Flow Control** fields.
4. Click **Apply Changes**. The LAG parameters are saved to the device.

Modifying LAG parameters:

1. Open the **LAG Configuration** page
2. Select a LAG in the **LAG** field.
3. Modify the **Description**, **Admin Status**, **Port Speed**, **Admin Auto Negotiation**, **Admin Speed**, and/or **Admin Flow Control** fields.
4. Click **Apply Changes**. The LAG parameters are saved to the device.

Displaying the LAG Configuration Table:

1. Open the **LAG Configuration** page.
2. Click **Show All**. The **LAG Configuration Table** opens.

LAG Configuration Table

LAG	Description	LAG Type	LAG Status	LAG Speed	Auto Negotiation	Flow Control
1			Up	100M	Enable	On
			Up	100M	Enable	On
2			Up	100M	Enable	On
			Up	100M	Enable	On
3			Up	100M	Enable	On
			Up	100M	Enable	On
4			Up	100M	Enable	On
			Up	100M	Enable	On
5			Up	100M	Enable	On
			Up	100M	Enable	On
6			Up	100M	Enable	On
			Up	100M	Enable	On

LAG Configuration Table

Configuring LAGs with CLI Commands

The following is an example of how to set up LAG with auto-negotiation disabled, 100Full.

At the system prompt, enter the following to set up static link aggregation:

```
console> en

console# config

console(config)# interface port-channel 1

console(config-if)# no neg

console(config-if)# speed 100

console(config-if)# exit

console(config)# interface range ethernet 1/e23-24

console(config-if)# no mdix

console(config-if)# no neg

console(config-if)# speed 100

console(config-if)# duplex full

console(config-if)# channel-group 1 mode on
```



```
console(config-if)# end
```

The following message displays:

```
console# sh interfaces status port-channel 1

Flow Link Back
ch Type Duplex Speed Neg Control State Pressure
.....

chl 100M Full 100 Disabled Off Up Disabled
```

The following table summarizes the equivalent CLI commands for configuring LAGs as displayed in the **LAG Configuration** page.

CLI Command	Description
<code>interface port-channel <i>port-channel-number</i></code>	Creates a port-channel and enters port-channel configuration mode.
<code>channel-group <i>port-channel-number</i> mode {on auto}</code>	Associates a port with a port-channel.
<code>show interfaces port-channel [<i>port-channel-number</i>]</code>	Displays Port-channel information (which ports are members of a Port-channel, and whether they are currently active or not).

The following is an example of the CLI commands:

```
Console (config)# interface ethernet 1/e5

Console (config-if)# channel-group 1 mode on

Console (config-if)# exit

Console (config-if)# exit

Console # show interfaces port-channel

Channel Port
-----

1 Active 1/e5, 2/e2 Inactive 3/e3

2 Active 1/e2

3 Inactive 3/e8
```

Enabling Storm Control

A Broadcast Storm is a result of an excessive amount of broadcast messages simultaneously transmitted across a network by a single port. Forwarded message responses are loaded onto the network, straining network resources or causing the network to time out.

Storm Control is enabled for all fast Ethernet ports or for Giga ports by defining the packet type and the rate the packets are transmitted. Ports can also be grouped to provide Storm protection for the entire group.

The system measures the incoming Broadcast, Multicast, and Unknown frame rate separately on each port, and discards frames when the rate exceeds a user-defined rate.

The **Storm Control** page allows network managers to enable and configure Storm Control. To open the **Storm Control** page :

- 1 Click **Switch > Ports > Storm Control** in the Tree View to open the **Storm Control** page.

The screenshot shows the Dell OpenManage Switch Administrator interface. The top navigation bar includes 'Support', 'Help', 'About', and 'Log Out'. The main header displays the IP address '176.210.1.1' and the title 'Storm Control'. On the left, a tree view shows the navigation path: Home > System > Switch > Ports > Storm Control. The main content area is titled 'Storm Control' and contains the following configuration fields:

- Interface:** A radio button for 'All Fast Ethernet Ports' (selected) and a radio button for 'Gigabit Ethernet Port' with a dropdown menu.
- Unknown Unicast Control:** A dropdown menu set to 'Disable'.
- Unknown Multicast Control:** A dropdown menu set to 'Disable'.
- Broadcast Control:** A dropdown menu set to 'Disable'.
- Rate Threshold (250-148000):** A text input field containing '0' followed by '(fps)'.

Buttons for 'Print', 'Refresh', 'Show All', and 'Apply Changes' are also visible.

Storm Control Page

The **Storm Control** page contains the following fields:

- 1 **Interface**—Indicates the interface on which storm control is being configured.
 - o **All Fast Ethernet Ports**—Indicates that storm control is enabled for all FE ports. Storm control can be applied individually to GE ports.
 - o **Gigabit Ethernet Port**—Indicates that storm control is enabled for the selected Gigabit Ethernet port. Storm control is either enabled or disabled for ALL FE ports.
- 1 **Unknown Unicast Control**—Enables moderating unknown Unicast packets on the device. The possible field values are:
 - o **Enable**—Enables moderating unknown Unicast packets on the device.
 - o **Disable**—Disables moderating unknown Unicast packets on the device.
- 1 **Unknown Multicast Control**—Enables moderating unknown Multicast packet on the device. The possible field values are:

- o **Enable**—Enables moderating unknown Multicast packets on the device.
 - o **Disable**—Disables moderating unknown Multicast packets on the device.
- 1 **Broadcast Control**—Enables moderating unknown broadcast packets. The possible field values are:
 - o **Enable**—Enables moderating Broadcast packets.
 - o **Disable**—Disables moderating Broadcast packets.
 - 1 **Rate Threshold (250-148000)**—Sets the broadcast packet rate limit for storm control. For FE ports, the range is 250-148,000. For GE ports the range is 250-262,143 packets. The default for FE ports is 148000, and for GE ports the default is 262,143.

Enabling Storm Control on the device:

1. Open the **Storm Control** page
2. Select an interface on which to implement storm control.
3. Define the **Unknown Unicast Control**, **Unknown Multicast Control**, **Broadcast Control**, and the **Rate Threshold (250-148000)** fields.
4. Click **Apply Changes**. Storm control is enabled on the device.

Modifying Storm Control port parameters:

1. Open the **Storm Control** page.
2. Modify the **Unknown Unicast Control**, **Unknown Multicast Control**, **Broadcast Control**, and the **Rate Threshold (250-148000)** fields.
3. Click **Apply Changes**. The storm control port parameters are saved to the device.

Displaying the Port Parameters Table:

1. Open the **Storm Control** page .
2. Click **Show All**. The **Storm Control Settings Table** opens.

Storm Control Settings Table

Fast Ethernet Ports	Unicast	Multicast	Broadcast	Rate Threshold
	Disable ▾	Disable ▾	Disable ▾	

Gigabit Ethernet Ports	Unicast	Multicast	Broadcast	Rate Threshold
	Disable ▾	Disable ▾	Disable ▾	

Storm Control Settings Table

Configuring Storm Control with CLI Commands

The following table summarizes the equivalent CLI commands for configuring storm control as displayed in the **Storm Control** page.

CLI Command	Description
<code>port storm-control enable {unknown broadcast multicast} {fastethernet gigaehternet interface}</code>	Enables broadcast storm control for Unicast, Multicast, and Broadcast packets.
<code>port storm-control rate gigaehternet interface rate.</code>	Configures the maximum broadcast rate.
<code>show ports storm-control</code>	Displays the storm control configuration.

The following is an example of the CLI commands:

```
Console(config)# port storm-control rate fastethernet 300
```

```
Console(config)# port storm-control enable fastethernet
```

```
Console# show ports storm-control
```

```
Port Unknown Broadcast Multicast Rate
```

```
[Packets/sec]
```

```
-----
```

```
GigaEthernet 1 Enabled Disabled Enabled 2000
```

```
GigaEthernet 2 Enabled Enabled Enabled 2000
```

```
FastEthernet Enabled Enabled Enabled 1000
```

Defining Port Mirroring Sessions

Port mirroring monitors and mirrors network traffic by forwarding copies of incoming and outgoing packets from one port to a monitoring port. Port mirroring can be used as a diagnostic tool and/or debugging feature. Port mirroring also enables switch performance monitoring.

Network administrators configure port mirroring by selecting a specific port to copy all packets, and different ports from which the packets are copied. Before configuring port mirroring, note the following:

- 1 Monitored ports cannot operate faster than the monitoring ports.
- 1 All the RX/TX packets should be monitored to the same port.
- 1 PowerConnect 3348 mirrors between ports 1-24 and ports 25-48 in the same unit. Mirroring is also possible to and from ports 25-48, and to and from ports 25-48 of a different PowerConnect 3348 or any PowerConnect 3324 port.
- 1 PowerConnect 3348 can mirror to any PowerConnect 3324 unit as long as the source port is not the G2 port. PowerConnect 3348 can mirror to and from another PowerConnect 3348 unit as long as the port is in the PowerConnect 25-48 port range.

The following restrictions apply to ports configured to be destination ports:

- 1 Ports cannot be configured as a source port.
- 1 Ports cannot be a LAG member.
- 1 IP interfaces are not configured on the port.
- 1 GVRP is not enabled on the port.
- 1 The port is not a VLAN member.
- 1 Only one destination port can be defined.

The following restrictions apply to ports configured to be source ports:

- 1 Source ports cannot be a LAG member.
- 1 Ports cannot be configured as a destination port.
- 1 All packets are tagged when they are transmitted from the destination port.

The following restriction applies to ports configured as source ports:

- 1 If any packet is received untagged on the source port, the packet is tagged with the default PVID of the source port when it is sent to the port mirroring destination port.

All the RX/TX packets should be monitored to the same port.

To open the **Port Mirroring** page:

1. Click **Switch > Ports > Port Mirroring** in the Tree View. The **Port Mirroring** page opens.

 **NOTE:** When a port is set to be a target port for a port-mirroring session, all normal operations on this port are suspended. These operations include Spanning Tree and LACP.

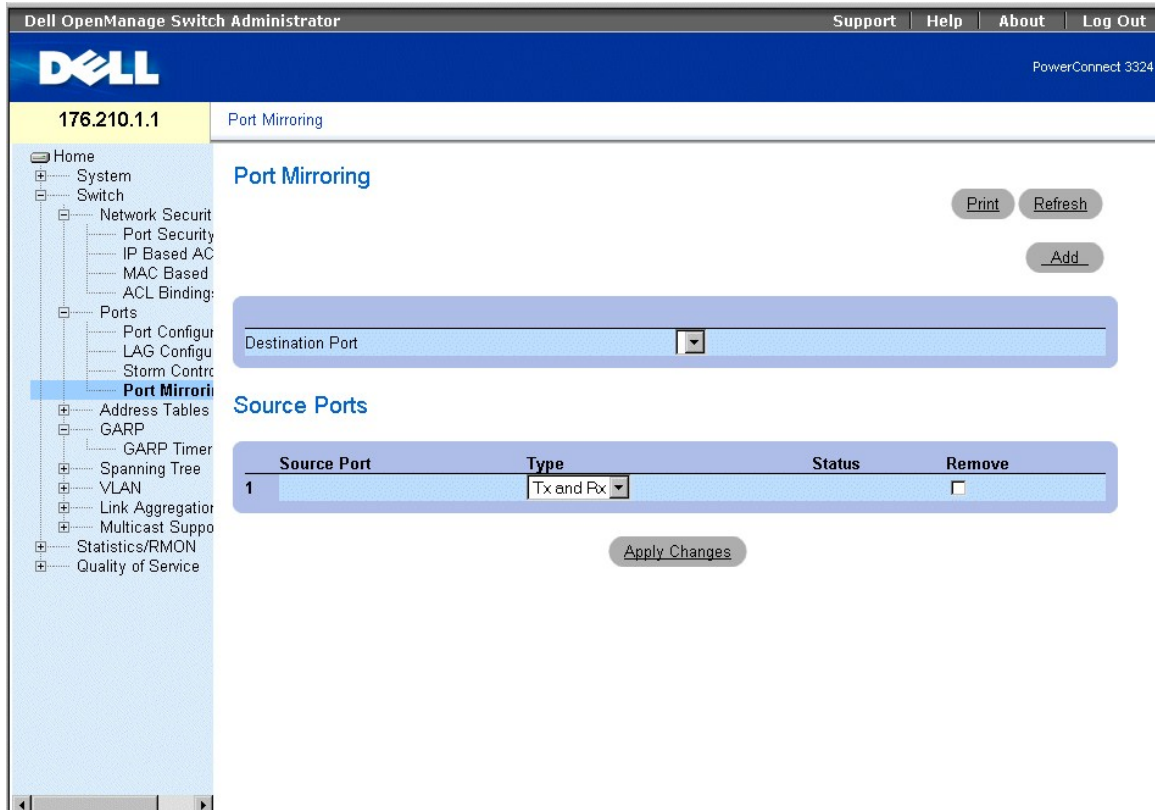

The screenshot shows the Dell OpenManage Switch Administrator interface. The top navigation bar includes 'Support', 'Help', 'About', and 'Log Out'. The main header displays the Dell logo and 'PowerConnect 3324'. The left sidebar shows a tree view with 'Port Mirroring' selected. The main content area is titled 'Port Mirroring' and contains a 'Destination Port' dropdown menu, a 'Source Ports' table, and buttons for 'Print', 'Refresh', 'Add', and 'Apply Changes'.

Source Port	Type	Status	Remove
1	Tx and Rx	Active	<input type="checkbox"/>

Port Mirroring Page

1. **Destination Port**—Defines the port number to which port traffic is mirrored. A copy port cannot mirror itself, cannot be a VLAN member other than the source port VLAN, and cannot be configured with an IP interface. All traffic on the source port is tagged.
1. **Source Port**—Defines the port number from which port traffic is copied. A maximum of 8 ports can be mirrored to one mirroring port.
1. **Type**—Specifies the port traffic type that is mirrored. The possible field values are:
 - o **RX**—Indicates that incoming traffic is mirrored.
 - o **TX**—Indicates that outgoing traffic is mirrored.
 - o **Both**—Indicates that both incoming and outgoing traffic is mirrored.
1. **Status**—Indicates the port state. The possible field values are:
 - o **Active**—Indicates the port is enabled, and receiving/ forwarding network traffic.
 - o **Not Active**—Indicates that the port is disabled, and is not receiving/forwarding network traffic.
1. **Remove**—Removes the port mirroring session. The possible field values are:
 - o **Checked**—Removes the port mirroring session.
 - o **Unchecked**—Maintains the port mirroring session.

Adding a port mirroring session:

1. Open the **Port Mirroring** page.
2. Click **Add**. The **Add Source Port** page opens.

Add Source Port

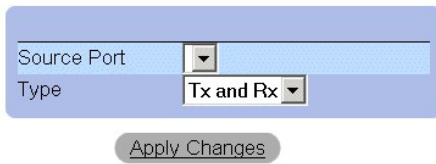

Source Port

Type

Add Source Port

3. Define the **Source Port** and **Type** fields.
4. Click **Apply Changes**. The new source port is defined, and the device is updated.

Deleting a copy port from a port mirroring session:

1. Open the **Port Mirroring** page.
2. Check the **Remove** check box.
3. Click **Apply Changes**. The port mirroring session is deleted, and the device is updated.

Configuring a Port Mirroring Session Using CLI Commands

The following table summarizes the equivalent CLI commands for configuring a Port Mirroring session as displayed in the **Port Mirroring** page.

CLI Command	Description
<code>port monitor src-interface [rx tx]</code>	Displays the port copy status.
<code>show ports monitor</code>	Starts a port monitoring session.

The following is an example of the CLI commands:

```
Console(config)# interface ethernet 1/e1
```

```
Console(config-if)# port monitor 1/e8
```

```
Console# show ports monitor
```

```
Source port Destination Port Type Status
```

```
-----
```

```
1/e1 1/e8 RX, TX Active
```

```
1/e2 1/e8 RX Active
```

Configuring Address Tables

MAC addresses are stored in either the Static Address or the Dynamic Address databases. A packet addressed to a destination stored in one of the databases is forwarded immediately to the port. The Static and Dynamic Address Tables can be sorted by interface, VLAN, and interface type. MAC addresses are dynamically learned as packets from sources arrive at the switch. Addresses are associated with ports by learning the ports from the frame's source address. Frames addressed to a destination MAC address that is not associated with any port are flooded to all ports of the relevant VLAN. Static addresses are manually configured by the user. In order to prevent the bridging table from overflowing, dynamic MAC addresses, are erased if they do not experience any traffic after a certain time period.

To open the **Address Tables** page:

- 1 Click **Switch > Address Tables** in the Tree View. The **Address Tables** page opens.

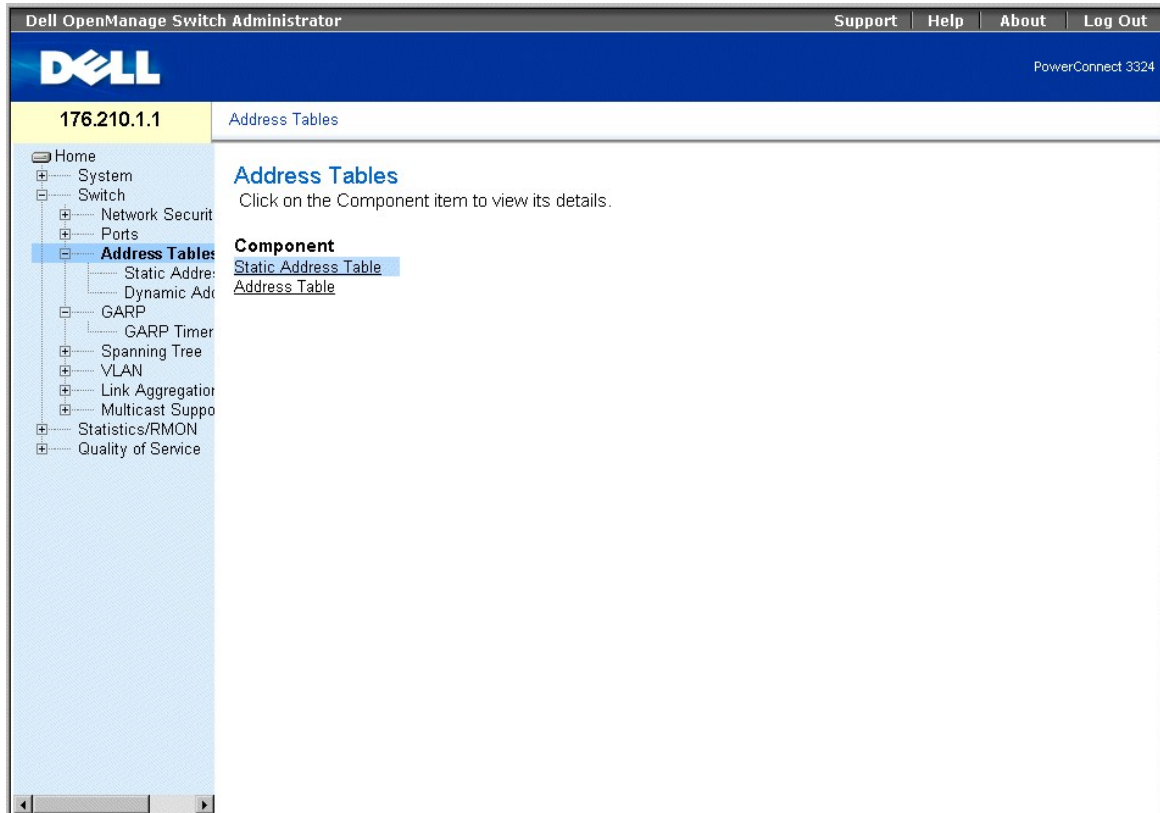

Address Tables Page

The **Address Tables** page contains links to the following:

- 1 [Defining Static Addresses](#)
- 1 [Viewing Dynamic Addresses](#)

Defining Static Addresses

The **Static MAC Address** page contains a list of static MAC addresses. Static addresses can be added and removed from the **Static MAC Address** page. In addition, several MAC addresses can be defined for a single port. To open the **Static MAC Address** page:

- 1 Click **Switch > Address Tables > Static Address** in the Tree View. The **Add Static MAC Address** page opens.

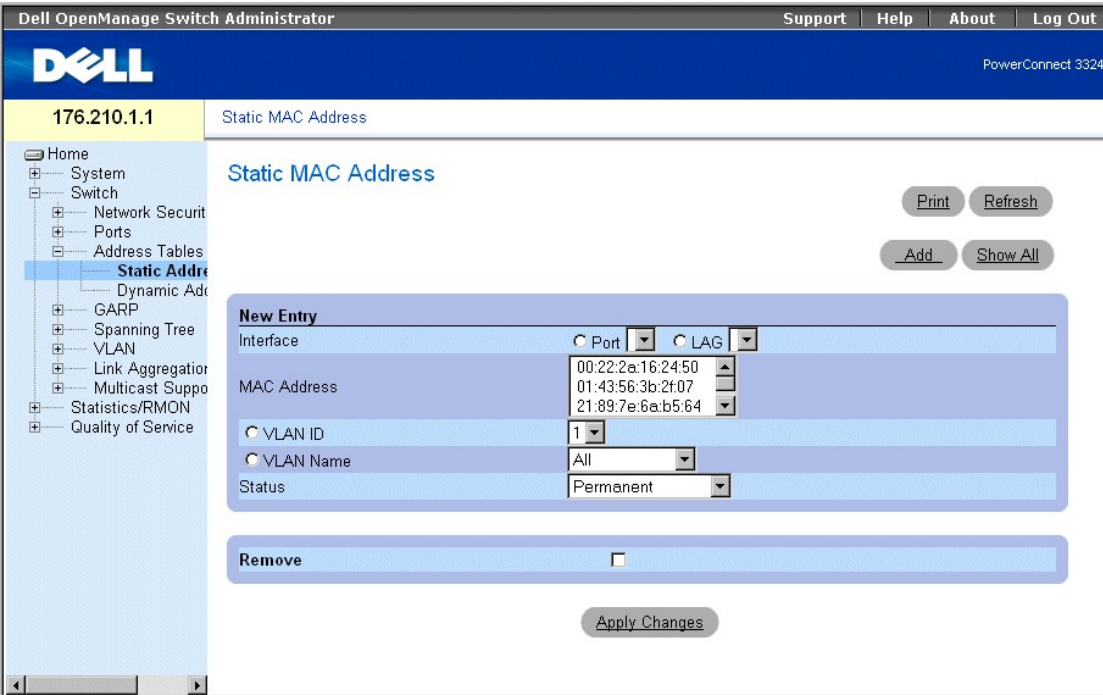

Add Static MAC Address Page

The **Add Static MAC Address** page contains the following fields:

- 1 **Interface**—Indicates the specific interface for which a static MAC address is added. The possible field values are:
 - o **Port**—Indicates the specific port for which a MAC address is added.
 - o **LAG**—Indicates the specific LAG for which a MAC address is added.
- 1 **MAC Address**—Specifies the MAC address listed in the **Current Static Address List**.
- 1 **VLAN ID**—Indicates the value of the VLAN ID attached to the MAC Address.
- 1 **VLAN Name**—Indicates the user-defined VLAN name.
- 1 **Status**—Defines the Static MAC address status. The possible field values are:
 - o **Permanent**—Indicates the MAC address is permanent.
 - o **Delete on Reset**—Indicates the MAC address is deleted when the device is reset.
 - o **Timeout**—Indicates the MAC address is deleted when the device times out.
 - o **Secure**—Guarantees that a Locked Port MAC address is not deleted. A secure MAC address is deleted from the [Port Security Page](#).

Adding a static address to the Static Address Table:

1. Open the **Static Address Table**.
2. Click **Add**. The **Add Static MAC Address** page opens.

Add Static MAC Address

Interface	<input type="radio"/> Port <input type="radio"/> LAG
MAC Address	<input type="text"/> (XX:XX:XX:XX:XX:XX)
<input type="radio"/> VLAN ID	1
<input type="radio"/> VLAN Name	Finance
Status	Permanent

Add Static MAC Address Page

3. Define the **Interface**, **MAC Address**, **VLAN ID** or **VLAN Name**, and the **Status** fields.
4. Click **Apply Changes**. The new static address is added to the Static Address table, and the device is updated.

Modifying a static address in the Static Address Table:

1. Open the **Static Address Table**.
2. Modify the **Port**, **MAC Address**, and the **VLAN** field.
3. Click **Apply Changes**. The static address is modified, and the device is updated.

Displaying the Static MAC Address Table:

1. Open the **Static Address Table**.
2. Click **Show All**. The **Static MAC Address Table** opens.

Static MAC Address Table

MAC	VLAN ID	Interface	Status	Remove
1			Permanent	<input type="checkbox"/>

Static MAC Address Table

Removing a static address from the Static Address Table:

1. Open the **Static Address Table**.
2. Click **Show All** to open the **Static MAC Address Table**.
3. Select a single or multiple table entries.
4. Check the **Remove** check box.
5. Click **Apply Changes**. The selected static addresses are deleted, and the device is updated.

Configuring Static Address Parameters Using CLI Commands

The following table summarizes the equivalent CLI commands for configuring static address parameters as displayed in the **Add Static MAC Address** page.

CLI Command	Description
<code>bridge address mac-address {ethernet interface port-channel port-channel-number} [permanent delete-on-reset delete-on-timeout secure]</code>	Adds a static MAC-layer station source address to the bridge table.

```
show bridge address-table static [vlan vlan] [ethernet interface | port-channel port-channel-number]
```

Displays classes of statically entered entries in the bridge-forwarding database.

The following is an example of the CLI commands:

```
Console (config-vlan)# bridge address 168.210.0.10 ethernet 1/e8 permanent
```

```
Console# show bridge address table static
```

```
Aging time is 300 sec
```

```
vlan mac address port type
```

```
-----
```

```
200 0010.0D48.37FF 5/9 delete-on-reset
```

Viewing Dynamic Addresses

The **Dynamic Address** page contains information about querying the **Dynamic Address Table**, including the interface type, MAC addresses, VLAN, and table sorting. Packets forwarded to an address stored in the Address Table are forwarded directly to those ports. To open the **Dynamic Address Page**:

- 1 Click **Switch > Address Tables > Dynamic Addresses** in the **Tree View**. The **Dynamic Address Table Page** page opens.

The screenshot shows the Dell OpenManage Switch Administrator interface. The top navigation bar includes 'Support', 'Help', 'About', and 'Log Out'. The main header displays the Dell logo and 'PowerConnect 3324'. The left sidebar shows a navigation tree with 'Dynamic Address Table' selected. The main content area is titled 'Dynamic Address Table' and contains the following configuration options:

- Address Aging (15-415):** A text input field containing '300' with '(Sec)' to its right.
- Apply Changes:** A button below the aging field.
- Query by:** A section with three checkboxes:
 - Port: A dropdown menu showing '1'.
 - MAC Address: A text input field with a placeholder '(XX:XX:XX:XX:XX:XX)'.
 - VLAN ID: A dropdown menu showing '1'.
- Address Table Sort Key:** A dropdown menu showing 'Address'.
- Query:** A button below the sort key.
- Current Address Table:** A table with the following structure:

VLAN ID	MAC	Port	Type
1			

Dynamic Address Table Page

The **Dynamic Address** page contains the following fields:

1. **Address Aging**—Specifies the amount of time the MAC Address remains in the **Dynamic Address Table** before it is timed out if no traffic from the source is detected. The default value is 300 seconds.
1. **Port**—Specifies the port numbers for which the table is queried.
1. **MAC Address**—Specifies the MAC address for which the table is queried.
1. **VLAN ID**—Indicates the VLAN ID for which the table is queried.
1. **Address Table Sort Key**—Specifies the method by which the Dynamic Address Table is sorted. The possible field values are:
 - o **Address**—Sorts the query results for a designated MAC address.
 - o **VLAN**—Sorts the query results by VLAN ID.
 - o **Interface**—Sorts the query results by interface, and displays all MAC addresses that have been learned on the designated port.

The **Query Results Table** contains the following columns:

1. **VLAN ID**—Indicates the VLAN Tag value.
1. **MAC**—Indicates the MAC address.
1. **Port**—Indicate the port that is attached to the dynamic MAC address.
1. **Type**—Indicates the MAC address type.

Redefining the Aging Time:

1. Open the **Dynamic Address Table**.
2. Define the **Aging Time** field.
3. Click **Apply Changes**. The aging time is modified, and the device is updated.

Querying the Dynamic Address Table:

1. Open the **Dynamic Address Table**.
2. Define the parameter by which to query the **Dynamic Address Table**. The **Dynamic Address Table** entries can be queried by interface, MAC Address, or VLAN.
3. Click **Query**. The **Dynamic Address Table** is queried. The query results are sorted by the selected **Address Table Sort Key** field value.

Querying and Sorting Dynamic Addresses Using CLI Commands

The following table summarizes the equivalent CLI commands for querying and sorting dynamic addresses as displayed in the **Dynamic Address Table** page.

CLI Command	Description
<code>bridge aging-time <i>seconds</i></code>	Sets the address table aging time.
<code>show bridge address-table [vlan <i>vlan</i>] [ethernet <i>interface</i> port-channel <i>port-channel-number</i>]</code>	Displays classes of dynamically created entries in the bridge-forwarding database.

The following is an example of the CLI commands:

```
Console (config)# bridge aging-time 250
```

```
Console (config)# exit
```

```
Console# show bridge address table
```

```
Aging time is 250 sec
```

```
vlan mac address port type
```

```
-----
```

```
1 0060.704C.73FF 5/e8 dynamic
```

```
1 0060.708C.73FF 5/e8 dynamic
```

```
200 0010.0D48.37FF 5/e9 static
```

Configuring GARP

Generic Attribute Registration Protocol (GARP) protocol is a general-purpose protocol that registers any network connectivity or membership-style information. GARP defines a set of devices interested in a given network attribute, such as VLAN or multicast address. To open the **GARP** page:

1. Click **Switch > GARP** in the Tree View. The **GARP** page opens.



176.210.1.1 GARP

- Home
 - System
 - Switch
 - Network Secur
 - Ports
 - Address Table
 - GARP**
 - GARP Timer
 - Spanning Tree
 - VLAN
 - Link Aggregati
 - Multicast Supp
 - Statistics/RMON
 - Quality of Service

GARP

Click on the Component item to view its details.

Component

[GARP Timers](#)

GARP Page

This section includes the following topic:

- 1 [Defining GARP Timers](#)

Defining GARP Timers

The **GARP Timers** page contains parameters for enabling GARP on the device. To open the **GARP Timers** page:

- 1 Click **Switch > GARP > GARP Timers** in the Tree View. The **GARP Timers** page opens.

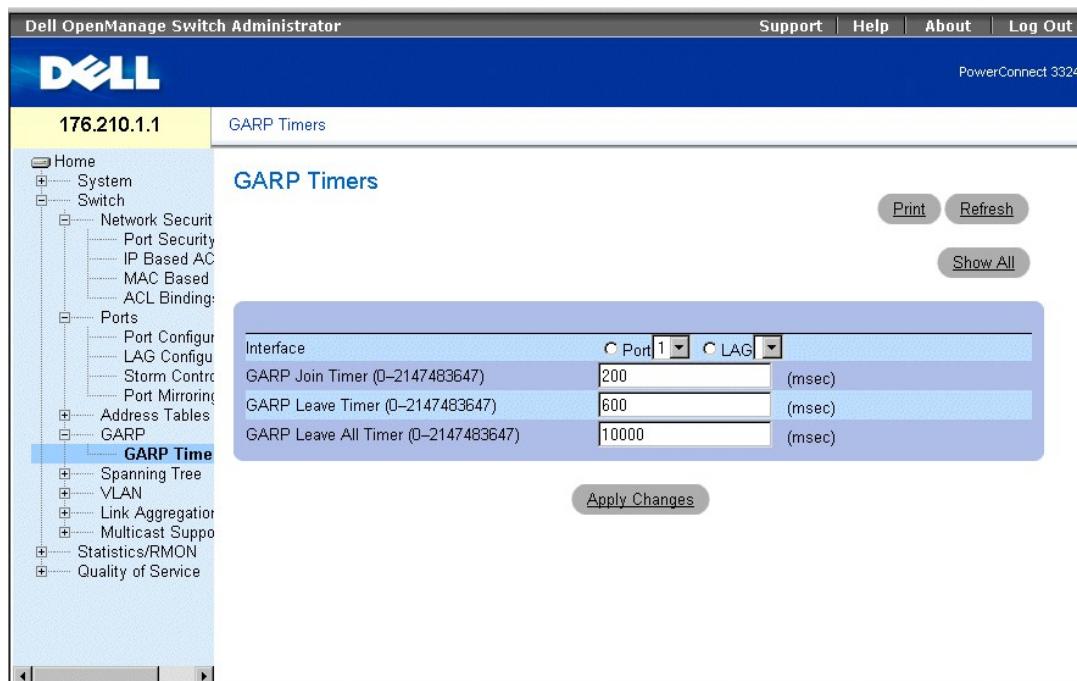

GARP Timers Page

The **GARP Timers** page contains the following fields:

- 1 **Interface**—Indicates the type of interface on which GARP Timers are shown. The possible field values are:
 - o **Port**—Indicates the port for which GARP Timers are displayed.
 - o **LAG**—Indicates the LAG for which GARP Timers are displayed.
- 1 **GARP Join Timer (10-2147483647)**—Indicates the time in milliseconds that PDUs are transmitted.
- 1 **GARP Leave Timer (10-2147483647)**—Indicates the time lapse in milliseconds that the device waits before leaving its GARP state. The **Leave Time** is activated by a **Leave All Time** message sent/received, and cancelled by the **Join** message received. The default is 600 milliseconds.
- 1 **GARP Leave All Timer (10-2147483647)**—Used to confirm the port within the VLAN. The time in milliseconds between messages sent. The default is 10000 milliseconds.

NOTE: The following relationships between the various timer values must be maintained: Leave time must be greater than or equal to three times the join time. Leave-all time must be greater than the leave time.

Defining GARP Timers:

1. Open the **GARP Timers** page.
2. Define the **Interface**, **GARP Join Time**, **GARP Leave Timer**, and **GARP Leave All Timer**.
3. Click **Apply Changes**. The GARP parameters are saved to the device.

Displaying the GARP Timers Table:

1. Open the **GARP Timers** page.
2. Click **Show All**. The **GARP Timers Table** opens.

GARP Timers Table

Unit No.

Copy Parameters from Port LAG

Interface	GARP Join Timer	GARP Leave Timer	GARP Leave All Timer	Copy to Select All
1	<input type="text"/>	<input type="text"/>	<input type="text"/>	<input type="checkbox"/>
2	<input type="text"/>	<input type="text"/>	<input type="text"/>	<input type="checkbox"/>

GARP Timers Table

In addition to the **GARP Timers** page fields, the **GARP Timers Table** page also displays the following fields:

- 1 **Unit No.**—Indicates the stacking unit number.
- 1 **Copy From**—Copies the port GVRP parameters to interfaces specified in the **Copy to** field.
- 1 **Copy To**—Indicates the interfaces to which the GVRP Timers are copied.

Copying GARP Information:

1. Open the **GARP Timers** page.
2. Click **Show All**. The **GARP Timers Table** opens.
3. Select an interface in the **Copy Parameters from** field.
4. Select the interfaces to which the GARP Timers information is copied in the **Copy To** fields.

Defining GARP Timers Using CLI Commands

The following table summarizes the equivalent CLI commands for defining GARP timers as displayed in the **GARP Timers** page.

CLI Command	Description
<code>garp timer {join leave leaveall} timer_value</code>	Sets the GARP application join, leave, and leaveall GARP timer values.

The following is an example of the CLI commands:

```
Console (config)# interface ethernet 1/e8
```

```
Console (config-if)# garp timer leave 900
```

Configuring the Spanning Tree Protocol

The Spanning Tree Protocol (STP) provides a single path between end stations on a Layer 2 network, thereby eliminating loops.

Loops occur when alternate routes exist between hosts. Loops in an extended network may cause bridges to forward traffic indefinitely, resulting in increased traffic and a reduction in network performance. To open the **Spanning Tree** page:

- 1 Click **Switch > Spanning Tree** in the Tree View. The **Spanning Tree** page opens.

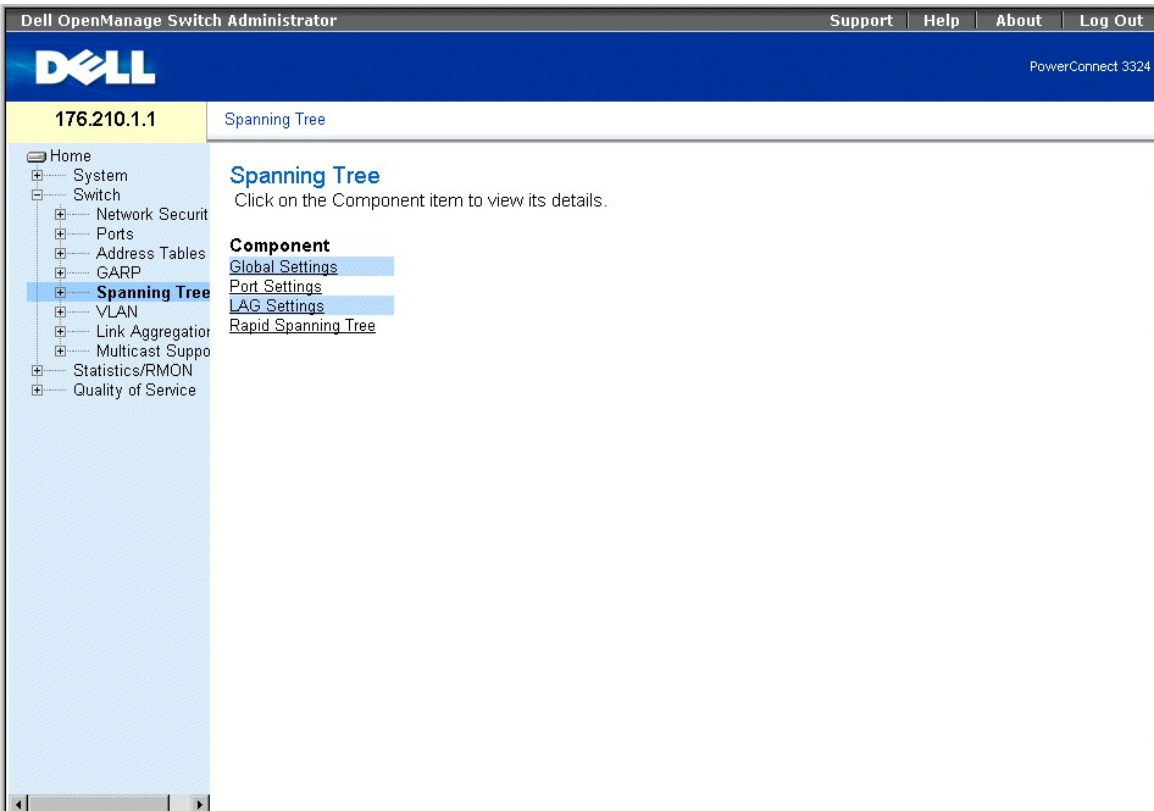

Spanning Tree Page

This section contains the following topics:

- 1 [Defining STP Global Settings](#)
- 1 [Defining STP Port Settings](#)
- 1 [Defining STP LAG Settings](#)
- 1 [Configuring Rapid Spanning Tree](#)

Defining STP Global Settings

The **Spanning Tree Global Parameters** page contains parameters for enabling and configuring STP operation on the device. To open the **Spanning Tree Global Parameters** page:

- 1 Click **Switch > Spanning Tree > Global Settings** in the Tree View. The **Spanning Tree Global Parameters** page opens.

The screenshot shows the Dell OpenManage Switch Administrator interface. The top navigation bar includes 'Support', 'Help', 'About', and 'Log Out'. The main header displays the Dell logo and 'PowerConnect 3324'. The left sidebar shows a navigation tree with 'Spanning Tree' selected. The main content area is titled 'Spanning Tree Global Settings' and contains the following configuration sections:

- Spanning Tree State:** Enable (dropdown)
- STP Operation Mode:** Rapid STP (dropdown)
- Bridge Settings:**
 - Priority (0-65535): [text input]
 - Hello Time (1-10): 2 (Sec)
 - Max Age (6-40): 20 (Sec)
 - Forward Delay (4-30): 15 (Sec)
- Designated Root:**
 - Bridge ID: [text input]
 - Root Bridge ID: [text input]
 - Root Port: [text input]
 - Root Path Cost: [text input]
 - Topology Changes Counts: [text input]
 - Last Topology Change: (D/H/M/S)

Buttons for 'Print', 'Refresh', and 'Apply Changes' are located at the bottom of the configuration area.

Spanning Tree Global Settings Page

The **Spanning Tree Global Parameters** page contains the following fields:

- 1 **Spanning Tree State**—Enables STP on the device. The possible field values are:
 - o **Enable**—Enables STP on the device.
 - o **Disable**—Disables STP on the device.
- 1 **STP Operation Mode**—Indicates the STP mode by which STP is enabled on the device. The possible field values are:
 - o **Classic STP**—Enables Classic STP on the device (IEEE 802.1D).
 - o **Rapid STP**—Enables Rapid STP is enabled on the device (IEEE 802.1w). For more information on Rapid STP, see "[Configuring Rapid Spanning Tree](#)".
- 1 **Priority (0-65535)**—Specifies the bridge priority value. When switches or bridges are running STP, each is assigned a priority. After exchanging BPDUs, the switch with the lowest priority value becomes the Root Bridge. The default value is 32768. The port priority value is incremented in multiples of 16; for example, 16, 32, 64, 80, and so on.
- 1 **Hello Time (1-10)**—Specifies the switch Hello Time. The Hello Time indicates the amount of time in seconds a root bridge waits between configuration messages. The default is 2 seconds.
- 1 **Max Age (6-40)**—Specifies the switch Maximum Age Time. The Maximum Age Time indicates the amount of time in seconds a bridge waits before sending configuration messages. The default maximum age time is 20 seconds.
- 1 **Forward Delay (4-30)**—Specifies the switch forward delay time. The Forward Delay Time indicates the amount of time in seconds a bridge remains in a listening and learning state before forwarding packets. The default is 15 seconds.
- 1 **Bridge ID**—Identifies the Bridge priority and MAC address.
- 1 **Root Bridge ID**—Identifies the Root Bridge priority and MAC address.
- 1 **Root Port**—Indicates the port number that offers the lowest cost path from this bridge to the Root Bridge. It is significant when the Bridge is not the Root. The default is zero.
- 1 **Root Path Cost**—The cost of the path from this bridge to the root.
- 1 **Topology Changes Counts**—Specifies the total amount of STP state changes that have occurred.
- 1 **Last Topology Change**—Indicates the amount of time that has elapsed since the bridge was initialized or reset, and the last topographic change occurred. The time is displayed in a day hour minute second format, for example, 2 days 5 hours 10 minutes and 4 seconds.

Defining STP Global Parameters:

1. Open the **Spanning Tree Global Parameters** page.
2. Select **Enable** in the **Spanning Tree State** field.
3. Select the **Classic STP** in the **STP Operation Mode** field.
4. Click **Apply Changes**. STP is enabled on the device.

Modifying STP Global Parameters:

1. Open the **Spanning Tree Global Parameters** page.
2. Define the **STP Operation Mode**, **Bridge Priority**, **Hello Time (Sec)**, **Max Age (Sec)**, and the **Forward Delay (Sec)** fields.
3. Click **Apply Changes**. The STP parameters are modified, and the device is updated.

Defining STP Global Parameters Using CLI Commands

The following table summarizes the equivalent CLI commands for defining STP Global Parameters as displayed in the **Spanning Tree Global Settings** page.

CLI Command	Description
<code>spanning-tree</code>	Enables spanning tree functionality.
<code>spanning-tree mode {stp rstp}</code>	Configures the spanning tree protocol currently running.
<code>spanning-tree priority <i>priority</i></code>	Configures the spanning tree priority.
<code>spanning-tree hello-time <i>seconds</i></code>	Configures the spanning tree bridge Hello Time, which is how often the switch broadcasts Hello messages to other switches.
<code>spanning-tree max-age <i>seconds</i></code>	Configures the spanning tree bridge maximum age, which determines the amount of time protocol information received on a port is stored by the switch.
<code>spanning-tree forward-time <i>seconds</i></code>	Configures the spanning tree bridge forward time, which is the amount of time a port remains in the listening and learning states before entering the forwarding state.
<code>show spanning-tree [ethernet <i>interface</i> port-channel <i>port-channel-number</i>]</code>	Displays spanning tree configuration.

The following is an example of the CLI commands:

```
Console(config)# spanning-tree
```

```
Console(config)# spanning-tree mode rstp
```

```
Console(config)# spanning-tree priority 12288
```

```
Console(config)# spanning-tree hello-time 5
```

```
Console(config)# spanning-tree max-age 10
```

```
Console(config)# spanning-tree forward-time 25
```

```
Console(config)# exit
```

```
Console# show spanning-tree
```

```
Spanning tree enabled mode RSTP
```

Root ID Priority 32768

Address X.X.X.X.X

Cost 57

Port 1/e1

Hello Time 2 sec Max Age 20 sec Forward Delay 15 sec

Bridge ID Priority 32769

Address X.X.X.X.X

Hello Time 2 sec Max Age 20 sec Forward Delay 15 sec

Number of topology changes 2 last change occurred 00:23:56 ago

Times: hold 1, topology change 35, notification 2

hello 2, max age 20, forward delay 15

Interface Port ID Designated Port ID

Name Prio Cost Sts Cost Bridge ID Prio.Nbr

1/e1 128 19 FWD 38 8000 00:30:94:41:62c1 80 001

1/e2 128 19 FWD 57 8000 00:02:4b:29:7a:00 80 002

chl 128 19 FWD 57 8000 00:02:4b:29:7a:00 80 003

Defining STP Port Settings

The **STP Port Settings** page allows network managers to assign STP properties to individual ports. To open the **STP Port Settings** page:

- 1 Click **Switch > Spanning Tree > Port Settings** in the Tree View. The **STP Port Settings** page opens.

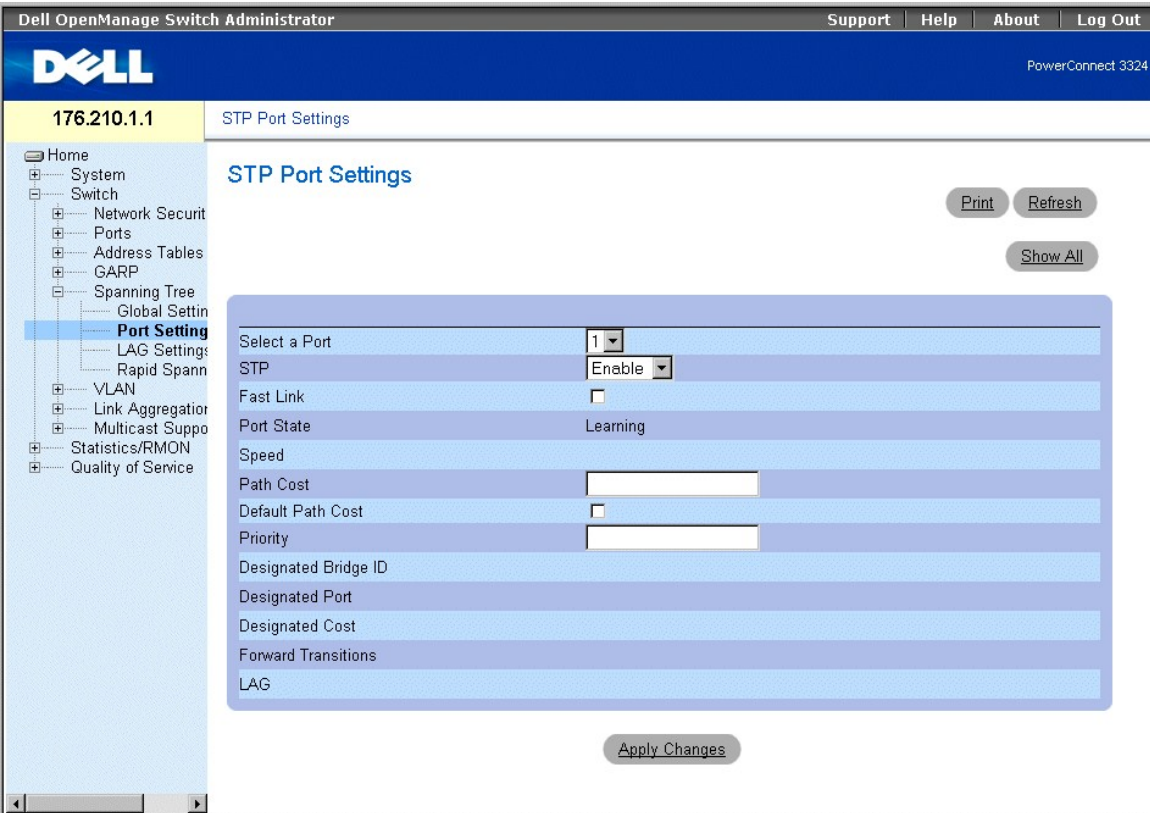

STP Port Settings Page

The **STP Port Settings** page contains the following fields:

- 1 **Select a Port**—Indicates the port for which STP statistics are displayed.
- 1 **STP**—Enables STP on the port. The possible field values are:
 - o **Enable**—Enables STP on the port.
 - o **Disable**—Disables STP on the port.
- 1 **Fast Link**—Enables Fast Link mode for the port. If Fast Link mode is enabled for a port, the port is automatically placed in the **Forwarding State** when the port link is up. Fast Link mode optimizes the time it takes for the STP protocol to converge (STP convergence can take 30-60 seconds in large networks).
- 1 **Port State**—Indicates the current STP state of a port. If enabled, the Port State determines what forwarding action is taken on traffic. The possible field values are:
 - o **Disabled**—Indicates the port link is currently down.
 - o **Blocking**—The port is currently blocked and cannot be used to forward traffic or learn MAC addresses.
 - o **Listening**—The port is currently in the listening mode. The port cannot forward traffic nor can it learn MAC addresses.
 - o **Learning**—The port is currently in the learning mode. The port cannot forward traffic however it can learn new MAC addresses.
 - o **Forwarding**—The port is currently in the forwarding mode. The port can forward traffic and learn new MAC addresses.
- 1 **Speed**—Indicates the port speed. The possible field values are:
 - o **10M**
 - o **100M**
 - o **1000M**
- 1 **Path Cost**—Indicates the amount this port contributes to the Root Path Cost. The Path Cost can be adjusted to a higher or lower value, and can forward traffic to or away from a path being rerouted. The path cost has a value of 1 to 65,535.
- 1 **Default Path Cost**—Specifies the default path cost.
- 1 **Priority**—Indicates the priority value of the port. The Priority value can be used to influence the port choice when a bridge has two ports connected in a loop on the same LAN. The priority value is between 0 -255.
- 1 **Designated Bridge ID**—Indicates the priority and the MAC Address of the designated bridge.
- 1 **Designated Port**—Indicates the priority and the MAC Address of the selected port on the designated bridge.

- 1 **Designated Cost**—Indicates the cost of the designated port participating in the STP topology.
- 1 **Forward Transitions**—Indicates the number of times the port has changed from the **blocking** state to **forwarding**.
- 1 **LAG**—Specifies the LAG to which the port is attached.

Enabling STP on a port:

1. Open the **STP Port Settings** page.
2. Select **Enabled** in the STP field.
3. Define the **Priority**, **Path Cost**, **Default Path Cost**, and the **Fast Link** fields.
4. Click **Apply Changes**. STP is enabled on the port.

Modifying STP Port Properties:

1. Open the **STP Port Settings** page.
2. Modify the **Priority**, **Path Cost**, **Default Path Cost**, and the **Fast Link** fields.
3. Click **Apply Changes**. The STP port parameters are modified, and the device is updated.

STP Port Table

Unit No. ▼

Port	STP	Port State	Speed	Path Cost (1-65535)	Default Path Cost	Priority (0-255)	Designated Bridge ID	Designated Port	Designated F Cost
1	Enable ▼	Disabled	1000M	19	<input type="checkbox"/>	128			

Apply Changes

STP Port Table Page

Defining STP Port Parameters Using CLI Commands

The following table summarizes the equivalent CLI commands for defining STP port parameters as displayed in the **STP Port Settings** page.

CLI Command	Description
<code>spanning-tree disable</code>	Disables spanning tree on a specific port.
<code>spanning-tree cost cost</code>	Configures the spanning tree port cost for a port.
<code>spanning-tree port-priority priority</code>	Configures port priority.
<code>show spanning-tree [ethernet interface port-channel port-channel-number]</code>	Displays spanning tree configuration.
<code>spanning-tree portfast</code>	Enables PortFast mode.

The following is an example of the CLI commands:

```
Console(config)# interface ethernet 1/e5
```

```
Console(config-if)# spanning-tree disable
```

```
Console(config-if)# spanning-tree cost 35000

Console(config-if)# spanning-tree port-priority 96

Console(config-if)# exit

Console(config)# exit

Console# show spanning-tree ethernet 1/e5

Console# show spanning-tree ethernet 1/e5

Interface Port ID Designated Port ID

Name Prio Sts Enb Cost Cost Bridge ID Prio.Nbr

-----

1/e5 128 DSBL True 100 0 8000 xx.xx.xx.xx.xx 80 001

Spanning tree enabled

Port Fast: no (configured: no)

Type: point-to-point (configured: auto)

Number of transitions to forwarding state: 1

BPDU: sent 2, received 120638
```

Defining STP LAG Settings

The **STP LAG Settings** page allows network managers to assign STP parameters for LAGs. To open the **STP LAG Settings** page:

- 1 Click **Switch > Spanning Tree > LAG Settings** in the Tree View. The **STP LAG Settings** page opens.

Dell OpenManage Switch Administrator Support | Help | About | Log Out

PowerConnect 3324

176.210.1.1 STP LAG Settings

- Home
- System
- Switch
- Network Secur
- Ports
- Address Table
- GARP
- Spanning Tree
 - Global Settir
 - Port Setting
 - LAG Setting**
 - Rapid Spani
- VLAN
- Link Aggregati
- Multicast Supp
- Statistics/RMON
- Quality of Service

STP LAG Settings

Print Refresh
Show All

Select a LAG	1
STP	Enable
Fast Link	<input type="checkbox"/>
LAG State	Learning
Speed	
Path Cost (1-65535)	
Default Path Cost	<input type="checkbox"/>
Priority (0-255)	
Designated Bridge ID	
Designated Port	
Designated Cost	
Forward Transitions	

Apply Changes

STP LAG Settings Page

The **STP LAG Settings** page contains the following fields:

- 1 **Select a LAG**—Indicates the user-defined LAG. For more information on defining LAGs, see "[Defining LAG Membership](#)".
- 1 **STP**—Enables STP on the LAG. The possible field values are:
 - o **Enable**—Enables STP on the LAG.
 - o **Disable**—Disables STP on the LAG.
- 1 **Fast Link**—Enables Fast Link for the LAG. If Fast Link is enabled for a LAG, the LAG is automatically placed in the **Forwarding State**. Fast Link optimizes the time it takes for the STP protocol to converge (STP convergence can take 30-60 seconds in large networks).

NOTE: Use the **Fast Link** option only in appropriate cases; for example, when the device is a leaf in the STP network topology for end stations.

- 1 **LAG State**—Indicates the current STP state for a LAG. If enabled, the LAG State determines what forwarding action is taken on traffic. If the bridge discovers a malfunctioning LAG, the LAG is placed in the **Disabled** state. The possible field values are:
 - o **Disabled**—The link is currently down.
 - o **Blocking**—The LAG is currently blocked and cannot be used to forward traffic or learn MAC addresses.
 - o **Listening**—The LAG is currently in the listening mode. The LAG cannot forward traffic or learn MAC addresses.
 - o **Learning**—The LAG is currently in the learning mode. The LAG cannot forward traffic; however, it can learn new MAC addresses.
 - o **Forwarding**—The LAG is currently in the forwarding mode. The LAG can forward traffic and learn new MAC addresses.
- 1 **Speed**—The speed of the ports comprising the LAG.
- 1 **Path Cost (1-65535)**—Indicates the amount this LAG contributes to the Root Path Cost. The Path Cost can be adjusted to a higher or lower value and can forward traffic to or away from a path being rerouted. The path cost has a value of 1 to 65,535.
- 1 **Default Path Cost**—Indicates the default path cost. The default path cost for a LAG is 4.
- 1 **Priority (0-255)**—Indicates the priority value of the LAG. The Priority value can be used to influence the LAG choice when a bridge has two looped ports on the same LAN. The priority value is between 0 -255.
- 1 **Designated Bridge ID**—Indicates the priority and MAC Address for the designated bridge.
- 1 **Designated Port**—Indicates the priority and MAC Address for the selected port.
- 1 **Designated Cost**—Indicates the Designated Cost.
- 1 **Forward Transitions**—Indicates the number of times the port has changed from the **blocking** state to **forwarding**.

Enabling STP on a LAG:

1. Open the **STP LAG Settings** page.
2. Select **Enable** in the STP field.
3. Define the **Priority**, **Path Cost**, and **Fast Link** fields.
4. Click **Apply Changes**. STP is enabled on the LAG, and the device is updated.

Modifying the LAG STP parameters:

1. Open the **STP LAG Settings** page.
2. Modify the **Priority**, **Path Cost**, and **Fast Link** fields.
3. Click **Apply Changes**. The STP LAG parameters are modified, and the device is updated.

STP LAG Table

LAG	Priority (0-255)	STP	State	Path Cost (1-65535)	Default Path Cost	Designated Bridge ID	Designated Port	Designated Cost	Forward Transition
1	128	Enable	Disabled	4	<input type="checkbox"/>				

[Apply Changes](#)

STP LAG Table Page

Defining STP LAG Parameters Using CLI Commands

The following table summarizes the equivalent CLI commands for defining STP LAG parameters as displayed in the **STP LAG Settings** page.

CLI Command	Description
<code>interface port-channel <i>port-channel-number</i></code>	Enters Port-channel configuration mode.
<code>spanning-tree port-priority <i>priority</i></code>	Configures LAG priority.

The following is an example of the CLI commands:

```
console(config)# interface port-channel 1

console(config-if)# spanning-tree port-priority 16
```

Configuring Rapid Spanning Tree

The Classic Spanning Tree prevents L2 forwarding loops in a general network topology. However, convergence can take up to 30-60 seconds. The convergence time is considered too long for many applications. When network topology allows, faster convergence may be possible. The Rapid Spanning Tree Protocol (RSTP) detects and uses network topologies that provide faster convergence of the spanning tree without creating forwarding loops.

STP has the following different port states:

- 1 Listening
- 1 Learning
- 1 Blocking
- 1 Forwarding

A listening port is either a designated or a root port, and is in the process of moving to the forwarding state. However, after the port is in the forwarding state, there is no way to determine whether the port is a root or designated port. The RSTP addresses this problem by decoupling the port's role and its state. Use the **Spanning Tree Global Settings** page to enable RSTP.

To open the **Rapid Spanning Tree (RSTP)** page:

- 1 Click **Switch > Spanning Tree > Rapid Spanning Tree** in the Tree View. The **Rapid Spanning Tree (RSTP)** page opens.

The screenshot shows the Dell OpenManage Switch Administrator interface. The top navigation bar includes 'Support', 'Help', 'About', and 'Log Out'. The main header displays the Dell logo and 'PowerConnect 3324'. The left sidebar shows a tree view with 'Rapid Span' selected. The main content area is titled 'Rapid Spanning Tree (RSTP)' and contains a configuration table with the following fields:

Interface	<input type="radio"/> Port 1	<input type="radio"/> LAG 1
Fast Link	Enable	
Point-to-Point Admin	Auto	
Point-to-Point Operational Status	Enable	
Activate Protocol Migration	<input type="checkbox"/>	

Buttons for 'Print', 'Refresh', 'Show All', and 'Apply Changes' are located on the right side of the configuration area.

Rapid Spanning Tree (RSTP) Page

The **Rapid Spanning Tree (RSTP)** page contains the following fields:

- 1 **Interface**—Indicates the interface number on which RSTP is enabled.
- 1 **Fast Link**—Indicates if Fast Link is enabled.

NOTE: Fast Link is enabled in the **STP Port Settings** page or the **STP LAG Settings** page. For more information about enabling Fast Link, see "[Defining STP Port Settings](#)" or "[Defining STP LAG Settings](#)".

- 1 **Point-to-Point Admin**—Specify the port link type as point-to-point. The possible field values are:
 - o **Auto**—Allows the device to automatically detect a point-to-point link.
 - o **Enable**—Enables establishing a point-to-point link.

- o **Disable**—Disables establishing a point-to-point link.
- 1 **Point-to-Point Operational Status**—Indicates the point-to-point operating state.
- 1 **Activate Protocol Migration** —Activates protocol migration. Protocol migration allows protocols to renegotiate with neighboring switches by testing the ports to see if they can migrate to RSTP. The possible field values are:
 - o **Checked**—Activates protocol migration.
 - o **Unchecked**—Disables protocol migration.

Enabling Rapid STP:

1. Open the **Rapid Spanning Tree (RSTP)** page.
2. Define the **Point-to-Point Admin**, **Protocol Operation**, and **Activate Protocol Migration** fields.
3. Click **Apply Changes**. The RSTP is enabled, and the device is updated.

Rapid Spanning Tree (RSTP) Table

Unit No. ▼

Port	Fast Link	Point-to-Point Admin	Point-to-Point Operation	Activate Protocol Migration
1	Enable	Auto ▼	Disable ▼	<input type="checkbox"/>

Apply Changes

Rapid Spanning Tree (RSTP) Table

Defining Rapid STP Parameters Using CLI Commands

The following table summarizes the equivalent CLI commands for defining RSTP parameters as displayed in the **Rapid Spanning Tree (RSTP)** page.

CLI Command	Description
<code>spanning-tree link-type {point-to-point shared}</code>	Overrides the default link-type setting, which is determined by the port duplex mode, and enables the Rapid Spanning-Tree Protocol (RSTP) transitions to the forwarding state.
<code>spanning tree mode {stp rstp}</code>	Configures the RSTP currently running.
<code>clear spanning-tree detected-protocols</code>	Restarts the protocol migration process.
<code>show spanning-tree [ethernet interface port-channel port-channel-number]</code>	Displays RSTP configuration.

The following is an example of the CLI commands:

```

Console(config)# interface ethernet 1/e5

Console(config-if)# spanning-tree link-type shared
  
```

Configuring VLANs

VLANs are logical subgroups of a Local Area Network (LAN) created by software rather than by defining a hardware solution. VLANs combine user stations and network devices into a single domain regardless of the physical LAN segment to which they are attached. VLANs allow network traffic to flow more efficiently within subgroups. VLANs managed through software reduce the amount of time in which network changes are implemented.

VLANs are software-based and not defined by physical attributes. As a result, VLANs have an unlimited number of ports and can be created per unit, per device, per stack, or any other logical connection combination.

VLANs function at Layer 2. Since VLANs isolate traffic within the VLAN, a Layer 3 functioning router is needed to allow traffic to flow between VLANs. Layer 3 routers identify segments and coordinate with VLANs. VLANs are broadcast and multicast domains. Broadcast and multicast traffic is only transmitted in the VLAN where the traffic is generated.

VLAN tagging provides a method for transferring VLAN information between VLAN groups. VLAN tagging attaches a four byte tag to packet headers. The VLAN tag indicates to which VLAN the packet belongs. VLAN tags are attached to the packet by either the end station or by the network device. VLAN tags also contain VLAN network priority information. Combining VLANs and GVRP allows network managers to automatically disperse VLAN information. To display the **VLAN** page:

- 1 Click **Switch > VLAN** in the Tree View. The **VLAN** page opens.

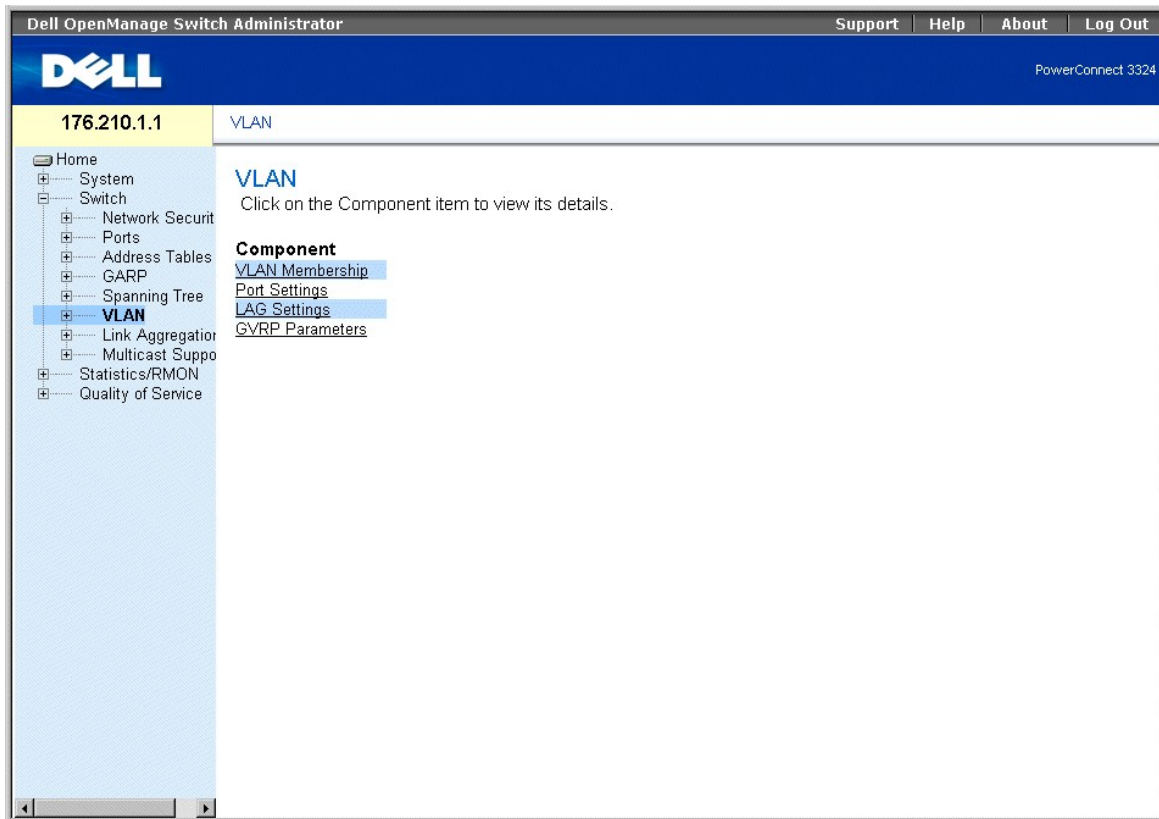

VLAN Page

The **VLAN** page contains links for defining the following:

- 1 [Defining VLAN Members](#)
- 1 [Defining VLAN Ports Settings](#)
- 1 [Defining VLAN LAG Settings](#)
- 1 [Configuring GVRP](#)

Defining VLAN Members

The **VLAN Membership** page allows network managers to define VLAN groups. To open the **VLAN Membership** page:

- 1 Click **Switch > VLAN > VLAN Membership** in the Tree View. The **VLAN Membership** page opens.

Dell OpenManagement Switch Administrator Support Help About Log Out

PowerConnect 3324

176.210.1.1 VLAN Membership

- Home
- System
- Switch
 - Network Security
 - Ports
 - Address Tables
 - GARP
 - Spanning Tree
 - VLAN**
 - Link Aggregation
 - Multicast Support
 - Statistics/RMON
 - Quality of Service

VLAN Membership

Show VLAN: VLAN ID VLAN Name

VLAN Name

Status

Remove VLAN

		Ports																						
		3	4	5	6	8	9	10	11	12	13	14	15	16	17	18	19	20	21	22	23	24	61	62
Static		T	T	T	T	T	T	T	T	T	T	T	T	T	T	T	T	T	T	T	T	T	T	T
Current		U	T	T	T	T	T	T	T	T	T	T	T	T	T	T	T	T	T	T	T	T	T	T

		LAGs					
		1	2	3	4	5	6
Static		F	T		T		
Current		U	T		T		

VLAN Membership Page

The **VLAN Membership** page is divided into the following sections:

- 1 [VLAN Membership Section](#)
- 1 [VLAN Port Membership Table](#)
- 1 [Defining VLAN LAG Settings](#)

VLAN Membership Section

The VLAN Membership Section contains parameters for assigning VLAN membership to ports. PowerConnect 3324/3348 supports up to 256 VLANs.

NOTE: All ports must have a defined PVID. If no other value is configured, use the default VLAN PVID.

Show VLAN: VLAN ID VLAN Name

VLAN Name

Status

Remove VLAN

VLAN Membership Section

The **VLAN Membership Section** contains the following fields:

- 1 **Show VLAN**—Lists and displays specific VLAN information according to:
 - o **VLAN ID**—Displays VLANs by VLAN ID. The default ID for the VLAN is 1. If the VLAN has an ID that is the current port Port Default VLAN ID (PVID), and the ID is deleted from the port, the port PVID is set to 1. VLAN number 1 cannot be deleted from the system. The VLAN range is 1-4095. VLAN 4095 is the Discard VLAN.
 - o **VLAN Name**—Displays VLAN according to the VLAN name.
- 1 **VLAN Name**—Displays or defines a user name for the VLAN.
- 1 **Status**—Indicates the VLAN type. VLANs are user-defined (permanent), created through GVRP, or are default VLANs. The possible field values are:
 - o **Dynamic**—Indicates the VLAN was dynamic created through GVRP.
 - o **Static**—Indicates the VLAN is user-defined.
 - o **Default**—Indicates the VLAN is the default VLAN.
- 1 **Remove**—Removes the VLAN from the **VLAN Membership Table**. The possible field values are:
 - o **Checked**—Removes the VLAN group from the VLAN Membership Table.
 - o **Unchecked**—Maintains the VLAN group in the VLAN Membership Table.

Adding new VLANs:

1. Open the **VLAN Membership** page.
2. Click **Add**. The **Create New VLAN** page opens:

Create New VLAN

The screenshot shows a light blue form with two input fields. The first field is labeled 'VLAN ID' and the second is labeled 'VLAN Name'. Both fields are currently empty.

Create New VLAN Page

3. Define the **VLAN ID** and **VLAN Name** fields.
4. Click **Apply Changes**. The new VLAN is added, and the device is updated.

Modifying VLAN Name Groups:

1. Open the **VLAN Membership** page.
2. Select a VLAN in the **Show VLAN** field.
3. Modify the **VLAN Name** field.
4. Click **Apply Changes**. The VLAN membership information is modified, and the device is updated.

Deleting a VLAN:

1. Open the **VLAN Membership** page.
2. Select a VLAN in the **Show VLAN** field.
3. Check the **Remove** check box.
4. Click **Apply Changes**. The VLAN is deleted, and the device is updated.

Defining VLAN Membership Groups Using CLI Commands

The following table summarizes the equivalent CLI commands for defining VLAN membership groups as displayed in the **VLAN Membership** page.

CLI Command	Description
<code>vlan database</code>	Enters the interface configuration (VLAN) mode.
<code>vlan {vlan-range}</code>	Creates a VLAN.

<code>name string</code>	Adds a name to a VLAN.
--------------------------	------------------------

The following is an example of the CLI commands:

```

Console # vlan database

Console (config-switch)#

Console (config-switch)# vlan 1972

Console (config-switch)# exit

Console (config)# interface vlan 19

Console (config-if)# name Marketing

```

VLAN Port Membership Table

The **VLAN Port Membership Table** contains a port table for assigning ports to VLANs. Ports are assigned VLAN membership by toggling through the port control settings. Ports can have the following values:

VLAN Port Membership Control Settings

Port Control	Definition
T	The interface is a member of a VLAN. All packets forwarded by the interface are tagged. The packets contain VLAN information.
U	The interface is a member of this member. Packets forwarded by the interface are untagged.
F	The interface is denied membership to a VLAN via GVRP.
Blank	The interface is not a member of this VLAN. Packets associated with the VLAN are not forwarded.

 **NOTE:** Ports that are LAG members are not displayed in the VLAN Port Membership Table.

The **VLAN Port Membership Table** displays the ports and the ports states, as well as LAGs.

Ports	
	3 4 5 6 8 9 10 11 12 13 14 15 16 17 18 19 20 21 22 23 24 G1 G2
Static	T T
Current	U T

LAGs	
	1 2 3 4 5 6 7 8
Static	F T T T
Current	U T T

VLAN Port Membership Table

Assigning ports to a VLAN group:

1. Open the **VLAN Membership** page.
2. Select a VLAN from the **Show VLAN** drop-down list.
3. Select ports in the **Port Membership Table**, and assign the port a value (**v**, **t**, **f**, or **b**).
4. Click **Apply Changes**. The ports are assigned to the VLAN group, and the device is updated.

Deleting VLANs:

1. Open the **VLAN Membership** page.
2. Select a VLAN from the **Show VLAN** drop-down list.
3. Check the **Remove** check box.
4. Click **Apply Changes**. The VLAN group is deleted, and the device is updated.

Assigning Ports to VLAN Groups Using CLI Commands

The following table summarizes the equivalent CLI commands for assigning ports to VLAN groups as displayed in the **VLAN Membership** page.

CLI Command	Description
vlan database	Enters the interface configuration (VLAN) mode.
vlan { <i>vlan-range</i> }	Creates or deletes a VLAN.
interface vlan <i>vlan-id</i>	Enters the interface configuration (VLAN) mode to configure an existing VLAN.
name <i>string</i>	Adds a name to a VLAN.
interface range ethernet { <i>port-range</i> all }	Enables command execution on multiple ports at the same time.
switchport forbidden vlan { add <i>vlan-list</i> remove <i>vlan-list</i> }	Forbids adding specific VLANs to the port

The following is an example of the CLI commands:

```
Console # vlan database

Console (config-vlan)# vlan 1972

Console (config-vlan)# exit

Console (config)# interface vlan 1972

Console (config-if)# name Marketing

Console (config-if)# exit

Console (config)# interface range ethernet 1/e18 - e20
```

Defining VLAN Ports Settings

The **VLAN Port Settings** page provides parameters for managing ports that are part of a VLAN.

The **Port Default VLAN ID (PVID)** is configured on the **VLAN Port Settings** page. All untagged packets arriving to the device are tagged by the ports PVID. To open the **VLAN Port Settings** page:

- 1 Click **Switch > VLAN > Port Settings** in the Tree View. The **VLAN Port Settings** page opens.

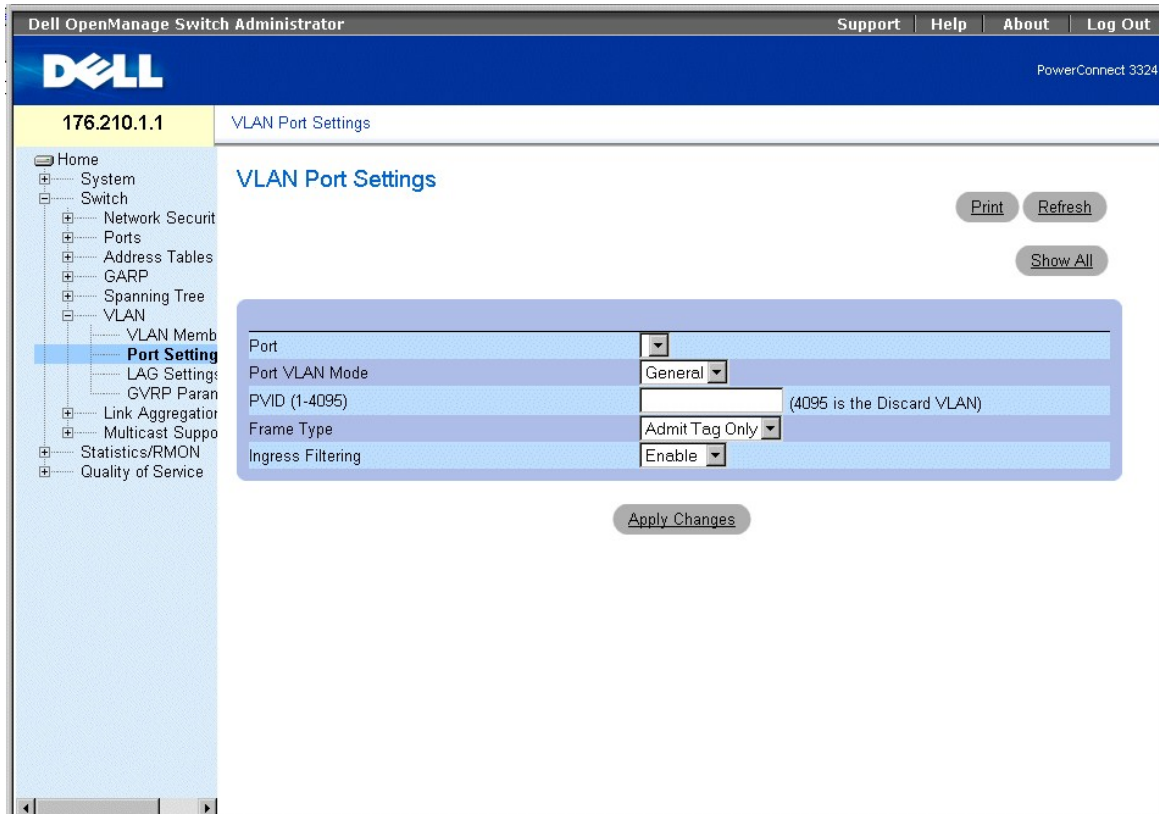

VLAN Port Settings Page

The **VLAN Port Settings** page contains the following fields:

- 1 **Port**—Indicates the port number included in the VLAN.
- 1 **Port VLAN Mode**—Designates the port VLAN mode. The possible field values are:
 - o **General**—Indicates that the port belongs to one or more VLANs, and each VLAN is user-defined as tagged or untagged (full 802.1Q mode). Ingress filtering can be disabled only in general-mode ports.
 - o **Access**—Indicates that the port belongs to a single untagged VLAN. Defining the port VLAN mode as access implies that the ports accept all untagged frames, and all frames tagged with the VID currently set as the port's PVID. Access mode ports are intended to connect end-stations to the system, especially when the end-stations are incapable of generating VLAN tags. Ingress filtering is enabled.
 - o **Trunk**—Indicates that the port belongs to a VLAN in which all frames are tagged. Ingress filtering is enabled on trunk-mode ports.
- 1 **PVID (1-4095)**—Assigns a VLAN ID to untagged packets. This is only implemented for general mode ports. The possible field value range is 1-4095.

NOTE: VLAN 4095 is the discard VLAN.

- 1 **Frame Type**—Indicates the packet type accepted on the port. The possible field values are:
 - o **Admit Tag Only**—Indicates that only tagged packets are accepted on the port.
 - o **Admit All**—Indicates that both tagged and untagged packets are accepted on the port.
- 1 **Ingress Filtering**—Enables Ingress filtering on the port. Ingress filtering discards packets that are associated with a VLAN that does not include the ingress port. The possible field values are:
 - o **Enable**—Enables ingress filtering on the port.
 - o **Disable**—Disable ingress filtering on the port.

Assigning port settings:

 **NOTE:** Ingress filtering can only be disabled on ports set to general VLAN mode.

1. Open the **VLAN Port Settings** page.
2. Define the **Port Mode**, **PVID**, **Frame Type**, and the **Ingress Filtering** fields.
3. Click **Apply Changes**. The VLAN port parameters are defined, and the device is updated.

Displaying the VLAN Port Table:

1. Open the **VLAN Port Settings** page.
2. Click **Show All**. The **VLAN Port Table** opens.

VLAN Port Table

Unit No.

Port	Port VLAN Mode	PVID	Frame Type	Ingress Filtering
1	General	<input type="text"/>	Admit Tag Only	Enable

VLAN Port Table

In addition to the **VLAN Port Settings** page fields, the **VLAN Port Table** page also displays the following field:

1. **Unit**—Indicates the stacking unit number for which the VLAN port information is displayed.

Assigning Ports to VLAN Groups Using CLI Commands

The following table summarizes the equivalent CLI commands for assigning ports to VLAN groups as displayed in the **VLAN Port Settings** page.

CLI Command	Description
<code>interface ethernet <i>interface</i></code>	Enters the interface configuration mode to configure an ethernet type interface.
<code>switchport mode {access trunk general}</code>	Configures a port VLAN membership mode.
<code>switchport general pvid <i>vlan-id</i></code>	Configure the Port VLAN ID (PVID) when the interface is in general mode.
<code>switchport general allowed vlan add <i>vlan-list</i> [tagged untagged]</code>	Adds VLANs to a general port.
<code>switchport general allowed vlan remove <i>vlan-list</i></code>	Removes VLANs from a general port.
<code>switchport general ingress-filtering disable</code>	Disables port ingress filtering.

The following is an example of the CLI commands:

```
Console (config)# interface range ethernet 1/e18 - e20
```

```
Console (config-if)# switchport mode access
```

```
Console (config-if)# switchport general pvid 234
```

```
Console (config-if)# switchport general allowed vlan add 1,2,5,6 tagged
```

```
Console (config-if)# switchport general ingress-filtering disable
```

Defining VLAN LAG Settings

The **VLAN LAG Settings** page provides parameters for managing LAGs that are part of a VLAN. VLANs are composed of individual ports or LAGs. Untagged packets entering the switch on a LAG are tagged as specified by the LAG's PVID. To open the **VLAN LAG Settings** page:

- 1 Click **Switch > VLAN > LAG Settings** in the Tree View. The **VLAN LAG Settings** page opens.

The screenshot shows the Dell OpenManage Switch Administrator interface. The top navigation bar includes 'Support', 'Help', 'About', and 'Log Out'. The main header displays the Dell logo and 'PowerConnect 3324'. The left sidebar shows a tree view with 'Home', 'System', 'Switch', 'Network Security', 'Ports', 'Address Tables', 'GARP', 'Spanning Tree', 'VLAN', 'VLAN Memb', 'Port Settings', 'LAG Setting', 'GVRP Paran', 'Link Aggregator', 'Multicast Suppo', 'Statistics/RMON', and 'Quality of Service'. The 'LAG Setting' option is selected. The main content area is titled 'VLAN LAG Settings' and contains a form with the following fields: LAG (dropdown), LAG VLAN Mode (General), PVID (1-4095) (text input, with a note '(4095 is the Discard VLAN)'), Frame Type (Admit Tag Only), and Ingress Filtering (Enable). There are buttons for 'Print', 'Refresh', 'Show All', and 'Apply Changes'.

VLAN LAG Setting Page

The **VLAN LACP Parameters** page contains the following fields:

- 1 **LAG**—Indicates the LAG number included in the VLAN.
- 1 **Port Mode**—Indicates the port mode. The possible field values are:
 - o **General**—Indicates that the LAG belongs to one or more VLANs, and each VLAN is user-defined as tagged or untagged (full 802.1Q compliance).

- o **Access**—Indicates that the LAG belongs to a single untagged VLAN.
- o **Trunk**—Indicates that the LAG belongs to a VLAN where all frames are tagged (except for an optional single native VLAN).
- 1 **PVID**—Assigns a VLAN ID to untagged packets. In order for LAGs to assign PVIDs, the LAG must be defined as untagged in the **VLAN Port Membership Table**.
- 1 **Frame Type**—Indicates the packet type accepted by the LAG. The possible field values are:
 - o **Admit Tag Only**—Indicates that only tagged packets are accepted by the LAG.
 - o **Admit All**—Indicates that both tagged and untagged packets are accepted by the LAG.
- 1 **Ingress Filtering**—Enables ingress filtering by the LAG. Ingress filtering discards packets which do not include an ingress port. The possible field values are:
 - o **Enable**—Enables ingress filtering by the LAG.
 - o **Disable**—Disable ingress filtering by the LAG.

Assigning LAG settings:

1. Open the **VLAN LAG Settings** page.
2. Define the **Port Mode**, **PVID**, **Frame Type**, and the **Ingress Filtering** fields.
3. Click **Apply Changes**. The VLAN LAG parameters are defined, and the device is updated.

Displaying the VLAN LAG Table:

1. Open the **VLAN LAG Settings** page.
2. Click **Show All**. The **VLAN LAG Table** opens.

VLAN LAG Table

LAG	LAG Mode	PVID	Frame Type	Ingress Filtering
1	General		Admit Tag Only	Enable

[Apply Changes](#)

VLAN LAG Table

Assigning LAGs to VLAN Groups Using CLI Commands

The following table summarizes the equivalent CLI commands for assigning LAGs to VLAN groups as displayed in the **VLAN LAG Settings** page.

CLI Command	Description
<code>switchport mode { access LAG general }</code>	Configures a port VLAN membership mode.
<code>switchport LAG native vlan <i>vlan-id</i></code>	Defines the LAG as a member of the specified VLAN, and the VLAN ID as the "port default VLAN ID (PVID)".
<code>switchport general pvid <i>vlan-id</i></code>	Configure the Port VLAN ID (PVID) when the interface is in general mode.
<code>switchport general allowed vlan add <i>vlan-list</i> [tagged untagged]</code>	Adds VLANs to a general port.
<code>switchport general allowed vlan remove <i>vlan-list</i> [tagged untagged]</code>	Removes VLANs from a general port.
<code>switchport general acceptable-frame-types tagged-only</code>	Discards untagged frames at ingress.
<code>switchport general ingress-filtering off</code>	Disables port ingress filtering.

The following is an example of the CLI commands:

```
Console (config)# interface port channel 1 1/e8
```

```
Console (config-if)# switchport mode access
```

```
console (config-if)# switchport LAG native vlan 123
```

```
Console (config-if)# switchport general pvid 234
```

```
Console (config-if)# switchport general allowed vlan add 1,2,5,6 tagged
```

```
Console (config-if)# switchport general acceptable-frame-types tagged-only
```

```
Console (config-if)# switchport general ingress-filtering disable
```

Configuring GVRP

The GARP VLAN Registration Protocol (GVRP) protocol is specifically provided for automatic distribution of VLAN membership information among VLAN-aware bridges. GVRP allows VLAN-aware bridges to automatically learn VLANs to bridge ports mapping, without having to individually configure each bridge, and to register VLAN membership.

To minimize the memory requirements when running the GVRP protocol, two proprietary tuning variables have been added to the standard variables:

- 1 **Maximum number of GVRP VLANs**—Displays the number of GVRP VLANs allowed to participate in GVRP operation.
- 1 **Maximum number of GVRP VLANs after Reset**—Sets another value for GVRP VLANs and is used for tuning. This value becomes valid after reset only.

The maximum number of GVRP VLANs includes all the VLANs participating in GVRP operation regardless whether they are static or dynamic.

The following should be considered when specifying the maximum number of VLANs participating in GVRP by setting the maximum number of GVRP VLANs after reset value:

- 1 The default maximum number of GVRP VLANs is equal to 128 because of the memory restrictions.
- 1 The maximum number of VLANs (managed through Max VLANs MIB variable) limits the maximum number of GVRP VLANs.

To ensure the correct operation of the GVRP protocol, users are advised to set the maximum number of GVRP VLANs equal to a value which significantly exceeds the sum of:

- 1 The number of all static VLANs both currently configured and expected to be configured.
- 1 The number of all dynamic VLANs participating in GVRP both currently configured (initial number of dynamic GVRP VLANs is 128) and expected to be configured.

Increasing the value of maximum number of the GVRP VLANs to a value beyond the sums, allows users to run GVRP, and not reset the device to receive a larger amount of GVRP VLANs. For example, if three VLANs exist and another two VLANs are expected to be configured as a result of VLAN static or dynamic registration, set the maximum number of GVRP VLANs after reset to 10. To open the **GVRP Parameters** page:

- 1 Click **Switch > VLAN > GVRP Parameters** in the Tree View. The **GVRP Parameters** page opens.

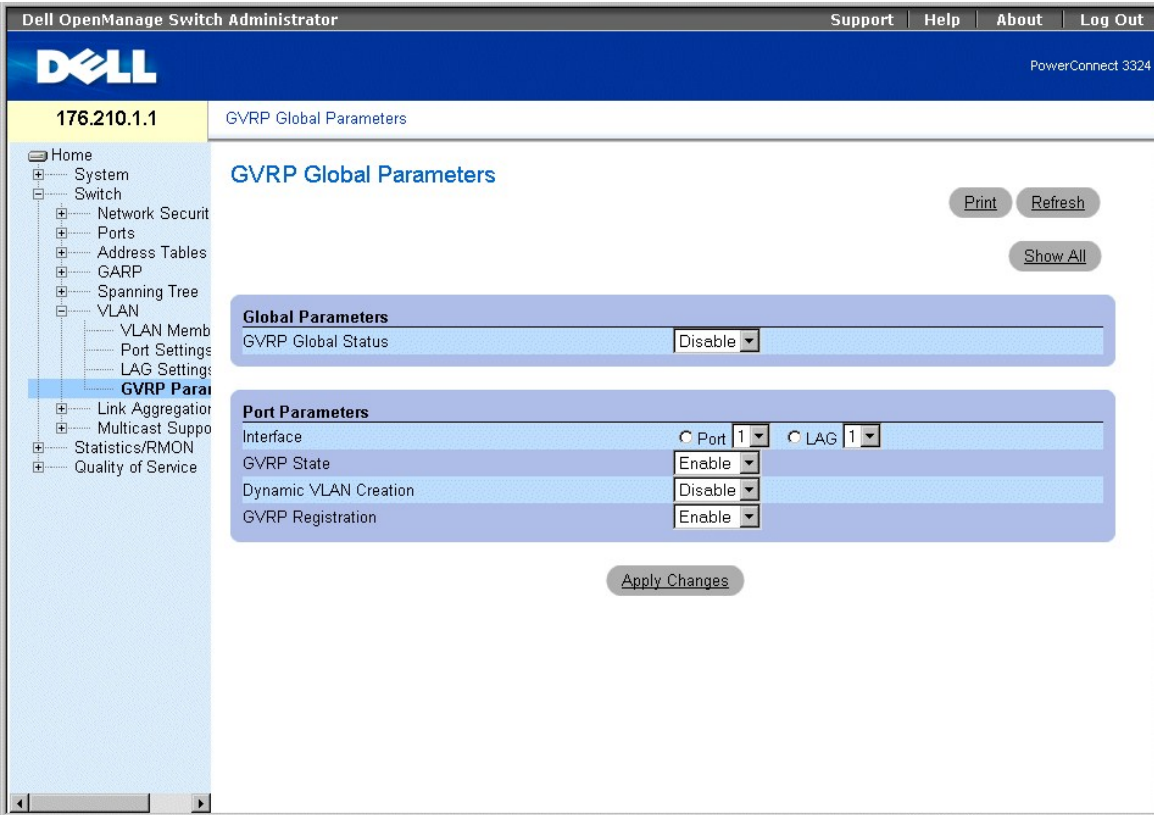

GVRP Parameters Page

The **GVRP Parameters** page contains the following fields:

- 1 **GVRP Global Status**—Enables GVRP on the device. The possible field values are:
 - o **Enabled**—Indicates GVRP is enabled on the device.
 - o **Disabled**—Indicates GVRP is disabled on the device. This field value is the default.
- 1 **Interface**—Indicates the specific interface for which GVRP is enabled. The possible field values are:
 - o **Port**—Indicates the specific port for which GVRP is enabled.
 - o **LAG**—Indicates the specific LAG for which GVRP is enabled.
- 1 **GVRP State**—Indicates if GVRP is enabled on a port. The possible field values are:
 - o **Enable**—Enables GVRP on the interface.
 - o **Disable**—Disables GVRP on the interface. This is the default value.
- 1 **Dynamic VLAN Creation**—Enables VLAN creation through GVRP. The possible field values are:
 - o **Enable**—Enables creating VLANs through GVRP.
 - o **Disable**—Disables creating VLANs through GVRP.
- 1 **GVRP Registration**—Enables GVRP registration status. The possible field values are:
 - o **Enable**—Enables VLAN registration through GVRP.
 - o **Disable**—Disables VLAN registration through GVRP.

Enabling GVRP on the device:

1. Open the **GVRP Parameters** page.
2. Select **Enable** in the **GVRP Global Status** field.
3. Click **Apply Changes**. GVRP is enabled on the device.

Defining GVRP Ports:

1. Open the **GVRP Parameters** page.
2. Click **Show All**. The **GVRP Parameters** page opens. The **GVRP Port Parameters** contains parameters for enabling GVRP on a port and permitting port to participate in VLAN registration through GVRP. In addition, the **GVRP Port Parameters Table** also contains information about the VLAN registration mode. Specific ports can also be blocked from registering or being used in a VLAN.
3. Select a port.
4. Define the **GVRP State**, **Dynamic VLAN Creation**, **VLAN Registration**, and the **GVRP Registration** fields.
5. Click **Apply Changes**. GVRP is enabled on the port, parameters are defined, and the device is updated.

Displaying the GVRP Port Parameters Table:

1. Open the **GVRP Parameters** page.
2. Click **Show All**. The **GVRP Port Parameters Table** opens.

GVRP Port Parameters Table

Unit No. ▼

Copy Parameters from Port ▼ LAG ▼

Interface	GVRP State	Dynamic VLAN Creation	GVRP Registration	Copy to Select All
1	Enable ▼	Enable ▼	Enable ▼	<input type="checkbox"/>
2	Enable ▼	Enable ▼	Enable ▼	<input type="checkbox"/>

Apply Changes

GVRP Port Parameters Table

In addition to the field displayed in the **GVRP Parameters** page , the **GVRP Port Parameters Table** page also displays the following fields:

- 1 **Unit**—Indicates the stacking unit number for which the GVRP information is displayed.
- 1 **Copy Parameters From**—Indicates the specific interface from which the GVRP parameters are copied.
- 1 **Copy To**—Indicates the ports to which the GVRP parameters are copied.

Configuring GVRP Using CLI Commands

The following table summarizes the equivalent CLI commands for configuring GVRP as displayed in the **GVRP Parameters** page.

CLI Command	Description
<code>gvrp enable</code>	Enables GVRP globally.
<code>gvrp enable</code>	Enables GVRP on an interface.
<code>gvrp vlan-creation-forbid</code>	Enables or disables dynamic VLAN creation.
<code>gvrp registration-forbid</code>	Unregisters all VLANs, and prevents dynamic VLAN creation or registration on the port.
<code>show gvrp configuration [ethernet interface port-channel <i>port-channel-number</i>]</code>	Displays GVRP configuration information, including timer values, whether GVRP and dynamic VLAN creation is enabled, and which ports are running GVRP.
<code>gvrp max-vlan number</code>	Configures the maximum number of VLANs when GVRP is enabled.

The following is an example of the CLI commands:

```
Console (config)# gvrp enable
```

```
Console (config)# interface ethernet 1/e8
```

```
Console (config-if)# gvrp enable
```

```
Console (config-if)# gvrp-vlan-creation-forbid
```

```
Console (config-if)# gvrp registration-forbid
```

```
Console# show gvrp configuration
```

```
GVRP Feature is currently enabled on the switch.
```

```
Maximum VLANs: 256, Maximum VLANs after reset: 256.
```

```
Port(s)Status Registration Dynamic VLAN Timers (milliseconds)
```

```
Creation Join Leave Leave All
```

```
-----
```

```
2/1 Enabled Normal Enabled 200 600 10000
```

```
4/4 Enabled Normal Enabled 200 600 10000
```

Aggregating Ports

Port Aggregation optimizes port usage by linking a group of ports together to form a single Link Aggregated Group (LAG). Port Aggregation multiplies the bandwidth between the devices, increases port flexibility, and provides link redundancy. Both the PowerConnect 3324 and PowerConnect 3348 support up to six LAGs, and eight ports per LAG per stack or stand-alone unit.

Each LAG is composed of ports of the same speed, set to full-duplex operations. Ports in a LAG, can be of different media types (UTP/Fiber, or different fiber types), provided they operate at the same speed.

Aggregated links can be assigned manually or automatically by enabling the Link Aggregation Control Protocol (LACP) on the relevant links. PowerConnect 3324/3348 provides LAG Load Balancing based on both source MAC addresses and destination MAC addresses.

Aggregated links are treated as a single logical port by the system. Specifically, the Aggregated link has similar port attributes to a non-aggregated port, including auto-negotiation, speed, duplex setting, and so forth.

PowerConnect 3324/3348 supports both static LAGs and Link Aggregation Control Protocol (LACP) LAGs. LACP LAGs negotiate aggregated port links with other LACP ports located on a different device. If the other device ports are also LACP ports, the devices establish a LAG between them.

Use the following guidelines when adding ports to a LAG for either a standalone or a stacking configuration:

- 1 No Layer 3 interface is defined on the port.
- 1 The port does not belong to any VLAN.

- 1 The port does not belong to any other LAG.
- 1 The port is not a mirrored port.
- 1 The port's 802.1p priority is equal to the LAG's 802.1p priority.
- 1 No ACL is defined on the port.
- 1 QoS Trust is not disabled on the port.
- 1 GVRP is not enabled.

 **NOTE:** Ports can be configured as LACP ports only if the ports are not part of a previously configured LAG.

PowerConnect 3324/3348 uses a hash function to determine which frames are carried on which aggregated-link member. The hash function statistically load-balances the aggregated link members. PowerConnect 3324/3348 considers an aggregated link to be a single logical port.

Each aggregated link has an aggregated link port type, including Gigabit Ethernet ports and Fast Ethernet ports. Ports can be added to an aggregated link only if they are the same port type. When ports are removed from an aggregated link, the ports revert to the original port settings. To open the **Link Aggregation** page:

- 1 Click **Switch > Link Aggregation** in the Tree View. The **Link Aggregation** page opens.

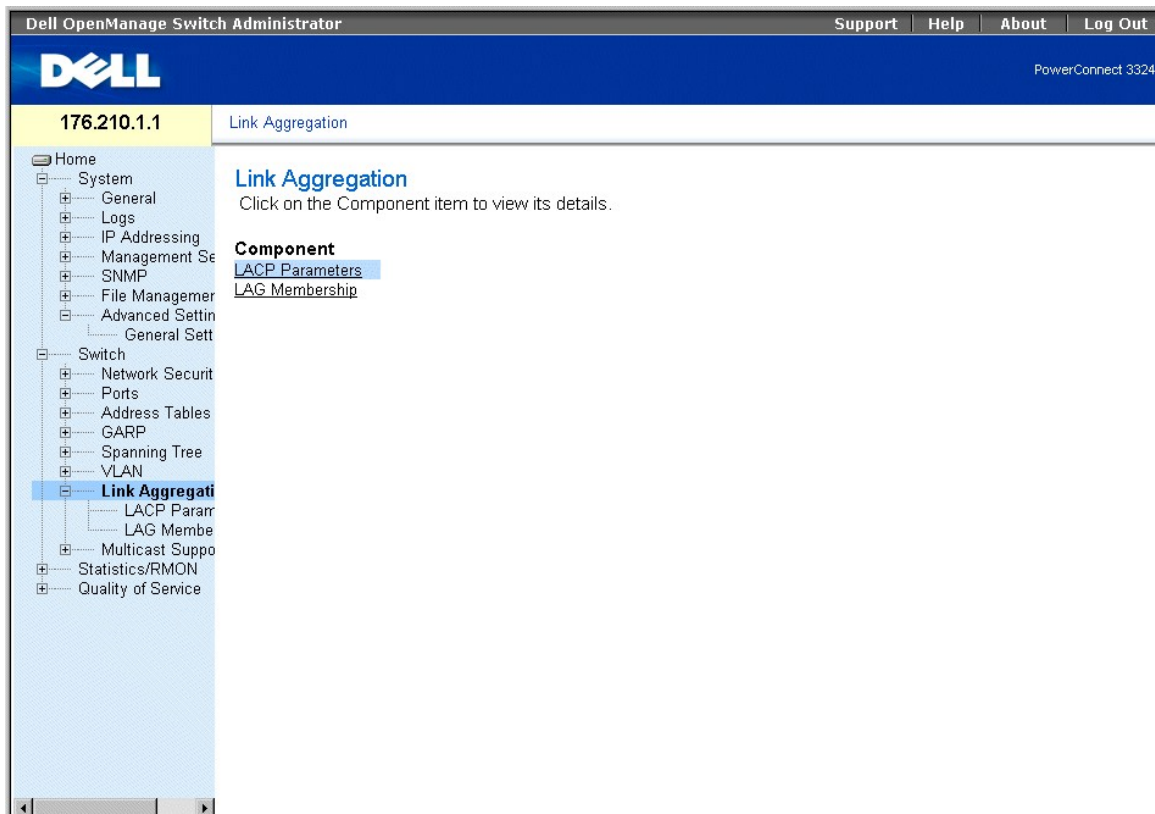

Link Aggregation Page

This section includes the following topics:

- 1 [Defining LACP Parameters](#)
- 1 [Defining LAG Membership](#)

Defining LACP Parameters

The **LACP Parameters** page contains information for configuring LACP LAGs. Aggregate ports can be linked into link-aggregation port-groups. Each group is comprised of ports with the same speed.

Aggregated links can be manually set up or automatically established by enabling the Link Aggregation Control Protocol (LACP) on the relevant links. To open the **LACP Parameters** page:

1. Click **Switch > Link Aggregation > LACP Parameters** in the Tree View. The **LACP Parameters** page opens.

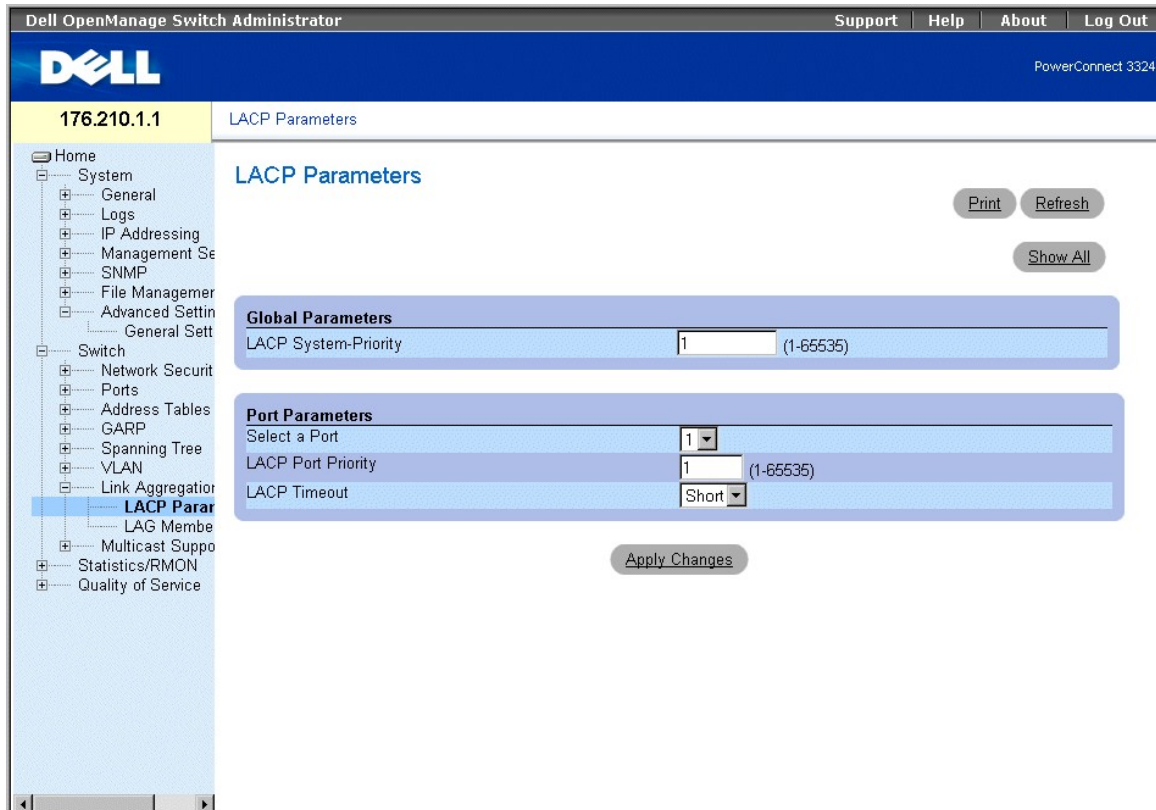

LACP Parameters Page

The **LACP Parameters** page contains the following sections:

1. [Global Parameters](#)
1. [Port Parameters Table](#)

Global Parameters

Global Parameters contains information for assigning LACP priority. Aggregate ports can be linked into link-aggregation port-groups. LAGs may be set up manually, by explicit user assignment, or automatically by enabling the Link Aggregation Control Protocol (LACP) on the relevant LAGs.

Global Parameters

Attribute	Value
LACP System-Priority	1

Global Parameters

The **Global Parameters** section contains the following field:

1. **LACP System Priority**—Indicates the LACP priority value. The possible range is 1-65535. The default value is 1.

Defining Global Parameters:

1. Open the **LACP Parameters** page.
2. Scroll to the **Global Parameters** section.
3. Define the **LACP System Priority** and the **LACP Timeout** fields.
4. Click **Apply Changes**. The Global Parameters are defined, and the device is updated.

Port Parameters Table

The **Port Parameters Table** contains information for assigning LACP priority and timeout values to ports:

Port Parameters	
Select a Port	1
LACP Port Priority	1 (1-65535)
LACP Timeout	Short

Port Parameters Table

The **Port Parameters** table contains the following fields:

1. **Select Port**—Indicates the port number.
1. **LACP Port Priority**—Indicates the port LACP priority value. The default is 1.
1. **LACP Timeout**—Assigns an administrative LACP timeout. The possible field values are:
 - o **Short**—Specifies a short timeout value.
 - o **Long**—Specifies a long timeout value.

Defining Port Parameters:

1. Open the **LACP Parameters** page.
2. Scroll to the **Link Aggregation Port Parameters Table**.
3. Define the **LACP System Priority** and the **LACP Timeout** fields.
4. Click **Apply Changes**. The Link Aggregation Global Parameters are defined, and the device is updated.

Displaying the LACP Parameters Table:

1. Open the **LACP Parameters** page.
2. Click **Show All**. The **LACP Parameters Table** opens.

LACP Parameters Table

Unit No.

Port	Port-Priority	LACP Timeout
	<input type="text" value="1"/>	<input type="text" value="Short"/>

LACP Parameters Table

In addition to the **LACP Parameters** page fields, the **LACP Parameters Table** page also displays the following field:

- 1 **Unit**—Indicates the stacking unit number for which the LACP information is displayed.

Configuring LACP Parameters Using CLI Commands

The following table summarizes the equivalent CLI commands for configuring LACP parameters as displayed in the **Link Aggregation** page.

CLI Command	Description
<code>lACP system-priority value</code>	Configures the system priority.
<code>lACP port-priority value</code>	Configures the priority value for physical ports.
<code>lACP timeout {long short}</code>	Assigns an administrative LACP timeout.
<code>show lACP ethernet interface [parameters statistics protocol-state]</code>	Displays LACP information for ethernet ports.
<code>show lACP port-channel [port_channel_number]</code>	Displays LACP information for a Port-channel.

The following is an example of the CLI commands:

```
Console (config)# lACP system-priority 120
```

```
Console (config)# interface ethernet 1/e8
```

```
Console (config-if)# lACP port-priority 247
```

```
Console (config-if)# lACP timeout long
```

```
Console (config-if)# exit
```

```
Console# show lACP ethernet 1/e1 statistics
```

```
Port 1/e1 LACP Statistics:
```

```
LACP PDUs sent:2
```

LACP PDUs received:2

Defining LAG Membership

The **LAG Membership** page allows network managers to assign ports to LAGs. LAGs can include up to 8 ports. Currently PowerConnect 3324/3348 supports 6 LAGs per system, whether the device is a standalone device or in a stack. The **LAG Membership Table** contains the following rows:

- 1 **LACP**—Indicates if the port is dynamic by allowing it to become a LAG member.
- 1 **LAG**—Adds a port to a LAG, and indicates the specific LAG to which the port belongs.

To open the **LAG Membership** page:

- 1 Click Switch > Link Aggregation > LAG Membership Tab in the Tree View. The **LAG Membership** page opens.

The screenshot shows the Dell OpenManage Switch Administrator interface. The top navigation bar includes 'Support', 'Help', 'About', and 'Log Out'. The main header displays the Dell logo and 'PowerConnect 3324'. The left sidebar shows a tree view with 'LAG Membership' selected. The main content area is titled 'LAG Membership' and contains a table with the following structure:

		Ports																									
		1	2	3	4	5	6	7	8	9	10	11	12	13	14	15	16	17	18	19	20	21	22	23	24	G1	G2
LACP		L	L					L			L																
LAG																											

Buttons: Print, Refresh, Apply Changes

LAG Membership Page

Adding a port to a LAG:

1. Open the **LAG Membership** page.
2. Toggle under the port number to assign the LAG setting and number.
3. Click **Apply Changes**. The port is added to the LAG, and the device is updated.

Assigning Ports to LAGs Using CLI Commands

The following table summarizes the equivalent CLI commands for assigning ports to LAGs as displayed in the **LAG Membership** page.

CLI Command	Description
<code>channel-group port-channel-number mode {on auto}</code>	Configures a port to a Port channel.
<code>show interface port_channel</code>	Displays the interfaces attached to a LAG.

The following is an example of the CLI commands:

```
Console# channel-group port-channel-number mode on auto 1
```

```
Port-Channel 1:Port Type 1000 Ethernet
```

```
Actor
```

```
System Priority:1
```

```
MAC Address: 000285:0E1C00
```

```
Admin Key: 29
```

```
Oper Key: 29
```

```
Partner
```

```
System Priority:0
```

```
MAC Address: 000000:000000
```

```
Oper Key: 14
```

Multicast Forwarding Support

Multicast forwarding allows a single packet to be forwarded to multiple destinations. L2 Multicast service is based on a L2 switch receiving a single packet addressed to a specific multicast addresses. Multicast forwarding creates copies of the packet, and transmits the packets to the relevant ports.

PowerConnect 3324/3348 supports both:

- 1 **Forwarding L2 Multicast Packets**—Enabled by default.
- 1 **Filtering L2 Multicast Packets**—Enables forwarding L2 packets to ports VLAN. If multicast filtering is disabled, multicast packets are flooded to all relevant VLAN ports.

To open the **Multicast Support** page:

- 1 Click **Switch > Multicast Support** in the Tree View. The **Multicast Support** page opens.

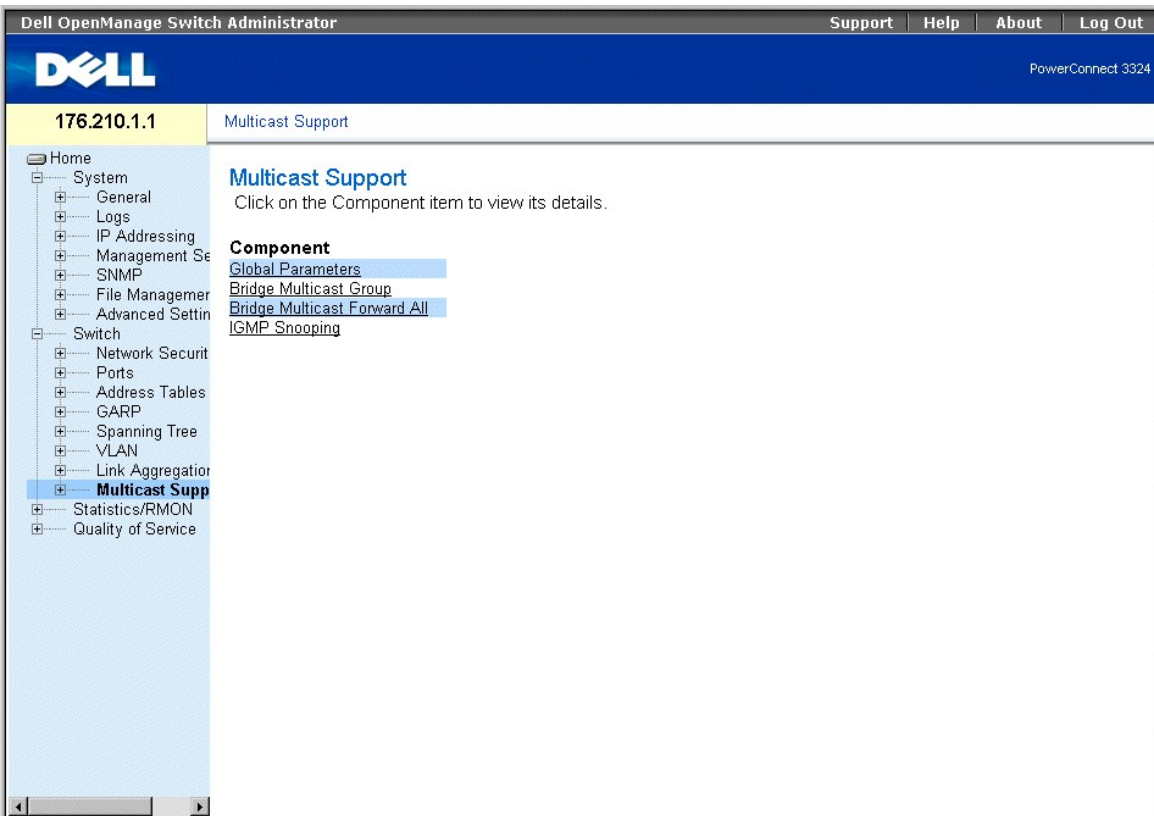

Multicast Support Page

The **Multicast Support** page includes links to the following topics:

- 1 [Defining IGMP Snooping Settings](#)
- 1 [Adding Bridge Multicast Group Members](#)
- 1 [Assigning Multicast Forward All Parameters](#)
- 1 [Enabling IGMP Snooping](#)

Defining IGMP Snooping Settings

Layer 2 switching forwards multicast packets to all relevant VLAN ports by default, treating the packet as a multicast packet. This type of traffic forwarding is functional; however, irrelevant ports also receive multicast traffic, causing increased network traffic.

IGMP snooping eliminates unnecessary multicast traffic by examining IGMP frames while they are forwarded from stations to a multicast routers.

When IGMP snooping is globally enabled, the switching ASIC is programmed to forward all IGMP frames to the CPU. The CPU analyzes the incoming frames and determines which ports want to join which Multicast groups, which ports have Multicast routers generating IGMP queries, and what Routing protocols are forwarding packets and Multicast traffic. A port wishing to join a specific multicast group issues an IGMP report specifying that multicast group.

The **Multicast Global Parameters** page allows network managers to enable IGMP Snooping and Multicast Filtering in general on the device. To open the **Multicast Global Parameters** page:

- 1 Click **Switch > Multicast Support > Global Parameters** in the Tree View. The **Multicast Global Parameters** page opens.

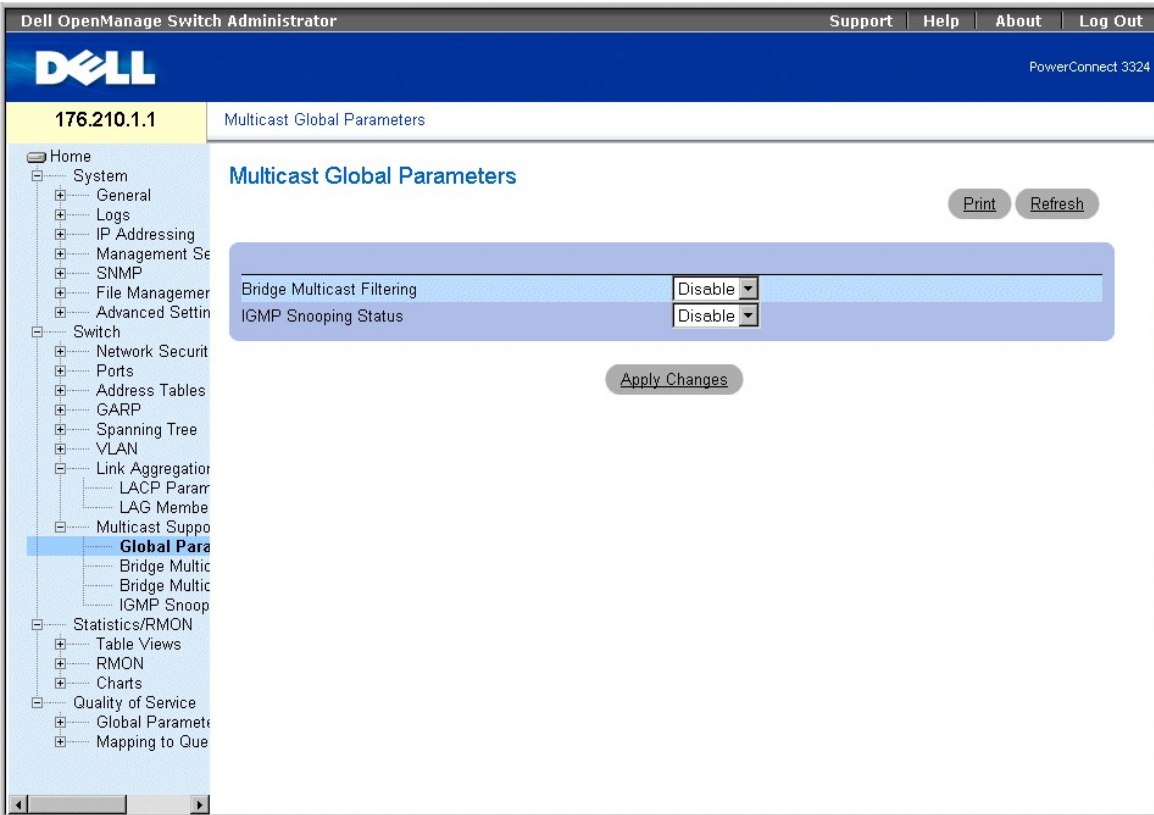

Multicast Global Parameters Page

The **Multicast Global Parameters** page contains the following fields:

1. **Bridge Multicast Filtering**—Indicates if bridge multicast filtering is enabled on the device. The possible field values are:
 - o **Enabled**—Enables bridge multicast filtering on the device.
 - o **Disabled**—Disables bridge multicast filtering on the device. This is the default value.
1. **IGMP Snooping Status**—Indicates if IGMP snooping is enabled on the device. The possible field values are:
 - o **Enabled**—Enables IGMP snooping on the specific VLAN.
 - o **Disabled**—Disables IGMP snooping on the specific VLAN. This is the default value.

Enabling bridge multicast filtering on the device:

1. Open the **Multicast Global Parameters** page.
2. Select **Enable** in the **bridge multicast filtering** field.
3. Click **Apply Changes**. **Bridge Multicast** is enabled on the device.

Enabling IGMP snooping on the device:

1. Open the **Multicast Global Parameters** page.
2. Select **Enable** in the **IGMP Snooping Status** field.
3. Click **Apply Changes**. IGMP snooping is enabled on the device.

Enabling Multicast Forwarding and IGMP Snooping Using CLI Commands

The following table summarizes the equivalent CLI commands for enabling multicast forwarding and IGMP snooping as displayed in the **Multicast Support** page.

CLI Command	Description
bridge multicast filtering	Enables filtering of multicast addresses.
ip igmp snooping	Enables Internet Group Management Protocol (IGMP) snooping.

The following is an example of the CLI commands:

```
Console (config)# bridge multicast filtering
```

```
Console (config)# ip igmp snooping
```

Adding Bridge Multicast Group Members

The **Bridge Multicast Group** page displays the ports and LAGs attached to the multicast service group in the **Port** and **LAG Table**. The Port and LAG tables also reflect the manner in which the port or LAGs joined the multicast group. Ports can be added either to existing groups or to new multicast service groups. The **Bridge Multicast Group** page permits new multicast service groups to be created. The **Bridge Multicast Group** page also assigns ports to a specific multicast service address group. To open the **Bridge Multicast Group** page:

- 1 Click **Switch > Multicast Support > Bridge Multicast Group** in the Tree View. The **Bridge Multicast Group** page opens.

The screenshot shows the Dell OpenManage Switch Administrator interface. The main content area is titled "Bridge Multicast Group". It features a configuration form with the following fields:

- VLAN ID: 1
- Bridge Multicast Address: 1.1.1.1
- Remove:

Below the form are two tables:

Ports	
	3 4 5 6 8 9 10 11 12 13 14 15 16 17 18 19 20 21 22 23 24 G1 G2
Static	S
Current	S D

LAGs	
	1 2 3 4 5 6
Static	S
Current	S D D

Buttons for "Print", "Refresh", "Add", and "Apply Changes" are present.

Bridge Multicast Group Page

The **Bridge Multicast Group** page contains the following fields:

- 1 **VLAN ID**—Identifies a VLAN.
- 1 **Bridge Multicast Address**—Identifies the multicast group IP address.

- 1 **Remove**—Removes a bridge multicast group specified by its address.
 - o **Checked**—Removes the bridge multicast address.
 - o **Unchecked**—Maintains the bridge multicast address.
- 1 **Ports Table**—Lists the port that can be added to a multicast service.
- 1 **LAGs Table**—Lists the LAGs that can be added to a multicast service.

The **IGMP Port/LAG Members Table** figure displays IGMP Port/LAG member status.

		Ports																							
		3	4	5	6	8	9	10	11	12	13	14	15	16	17	18	19	20	21	22	23	24	G1	G2	
Static		S																							
Current		S	D	D	D	D	D	D	D	D	D	D	D	D	D	D	D	D	D	D	D	D	D	D	

		LAGs							
		1	2	3	4	5	6	7	8
Static		S							
Current		S	D		D				

IGMP Port/LAG Members Table

The **IGMP Port/LAG Members Table Control Settings Table** contains the settings for managing IGMP port and LAG members.

Port Control	Definition
D	Indicates that the port/LAG has joined the multicast group dynamically in the Current row.
S	Attaches the port to the multicast group as static member in the Static Row. Indicates that the port/LAG has joined the Multicast group statically in the Current row.
F	Indicates that the port is forbidden to join this multicast group.
Blank	Indicates that the port is not attached to the multicast group.

IGMP Port/LAG Members Table Control Settings

Defining ports to receive multicast service:

1. Open the **Bridge Multicast** page.
2. Define the **VLAN ID** and the **Bridge Multicast Address** fields.
3. Toggle a port to **S** to join the port to a selected multicast group, or Toggle a port to **F** to forbid the port from joining that multicast group.
4. Click **Apply Changes**. The port is assigned to the multicast group, and the device is updated.

Assigning LAGs to receive multicast service:

1. Open the **Bridge Multicast** page.
2. Define the **VLAN ID** and the **Bridge Multicast Address** fields.
3. Toggle the LAG to **S** to join the LAG to the selected multicast group, or toggle a port to **F** to forbid the port from joining a multicast group.
4. Click **Apply Changes**. The LAG is assigned to the multicast group, and the device is updated.

Managing Multicast Service Members Using CLI Commands

The following table summarizes the equivalent CLI commands for managing multicast service members as displayed in the **Bridge Multicast Group** page.

CLI Command	Description
<code>bridge multicast address {mac-multicast-address ip-multicast-address} {add remove} {ethernet interface-list port-channel port-channel-number-list}</code>	Registers MAC-layer multicast addresses to the bridge table, and adds static ports to the group.
<code>show bridge multicast address-table [vlan vlan-id] [address mac-multicast-address ip-multicast-address] [format ip mac]</code>	Displays multicast MAC address table information.

The following is an example of the CLI commands:

```
Console (config)# interface vlan 8

bridge multicast address 0100.5e02.0203

bridge multicast address 0100.5e02.0203 add ethernet 1/e1, 2/e2

Console (config-if)# Exit

Console # show bridge multicast address-table

Vlan MAC Address type Ports
-----
1 0100.5e02.0203 static 1/e1, 2/e2

19 0100.5e02.0208 static 1/e1-8

19 0100.5e02.0208 dynamic 1/e9-11

Forbidden ports for multicast addresses:

Vlan MAC Address Ports
-----
1 0100.5e02.0203 2/e8

19 0100.5e02.0208 2/e8
```

Assigning Multicast Forward All Parameters

The **Bridge Multicast Forward All** page allows network managers to enable attaching ports or LAGs to a switch attached to a neighboring multicast router/switch. Once IGMP snooping is enabled, multicast packets are forwarded to the appropriate port or VLAN.

- 1 Click **Switch > Multicast Support > Bridge Multicast > Bridge Multicast Forward All Tab** in the Tree View. The **Bridge Multicast Forward All** page opens.

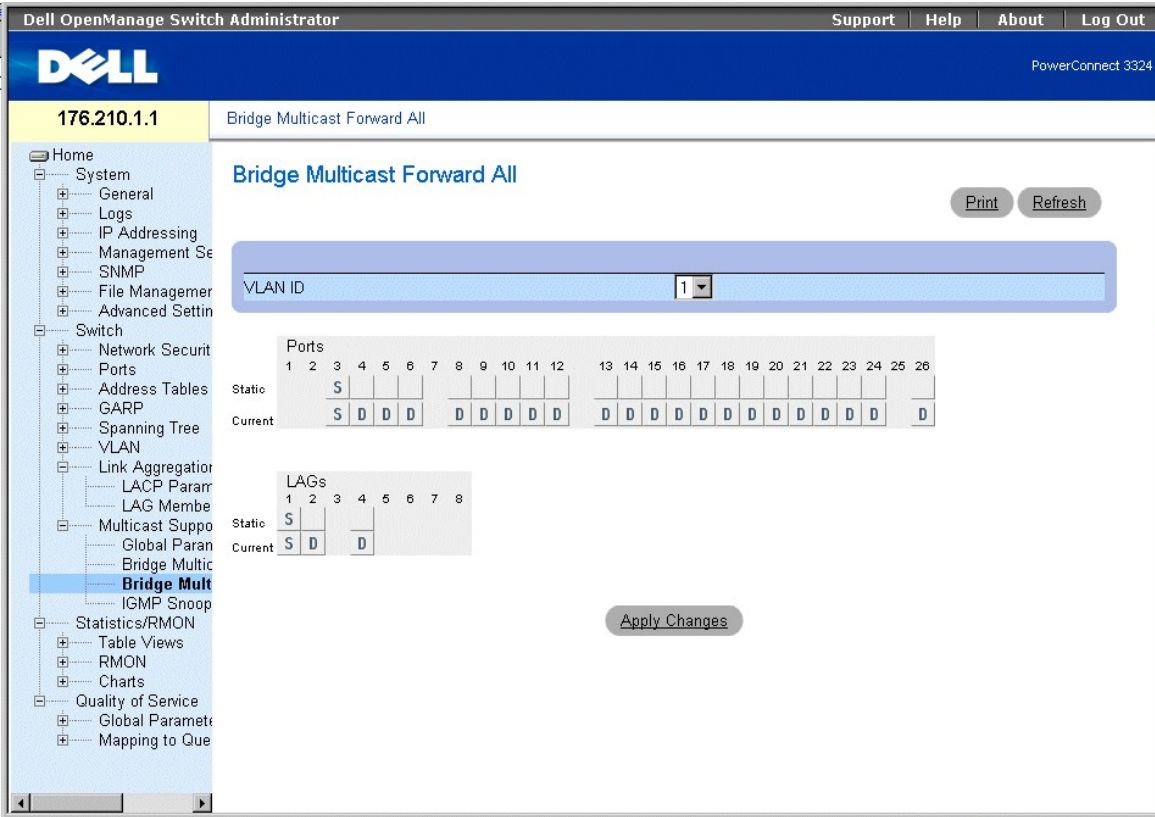

Bridge Multicast Forward All Page

The **Bridge Multicast Forward All** page contains the following fields:

- 1 **VLAN ID**—Identifies a frame VLAN and contains information about the multicast group address.
- 1 **Ports Table**—Lists the port that can be added to a multicast service.
- 1 **LAGs Table**—Lists the LAGs that can be added to a multicast service.

The **Bridge Multicast Forward All** page contains the settings for managing switch and port settings.

Port Control	Definition
D	Attaches the port to the multicast router or switch as a dynamic port.
S	Attaches the port to the multicast router or switch as a static port.
F	Indicates that the port is forbidden from joining a multicast group.
Blank	Indicates that the port is not attached to a multicast router or switch.

Bridge Multicast Forward All Router/Port Control Settings

Attaching a port to multicast router or switch:

1. Open **Bridge Multicast Forward All** page.
2. Define the **VLAN ID** field.
3. Select a port in the **Multicast Router Port Table**, and assign the port a value.
4. Click **Apply Changes**. The port attached to the multicast router or group is updated.

Attaching a LAG to multicast router or switch:

1. Open **Bridge Multicast Forward All** page.
2. Define the **VLAN ID** field.

3. Select a LAG in the **Multicast Router Port Table** and assign a value to the LAG.
4. Click **Apply Changes**. The LAG attached to the multicast router or group is updated.

Managing LAGs and Ports Attached to Multicast Routers Using CLI Commands

The following table summarizes the equivalent CLI commands for managing LAGs and ports attached to multicast routers as displayed in the **Bridge Multicast Forward All** page.

CLI Command	Description
<code>show bridge multicast filtering <i>vlan-id</i></code>	Displays the multicast configuration.
<code>bridge multicast forbidden forward-all</code>	Disables forwarding multicast packets on a port.
<code>bridge multicast forward-all {add remove} {ethernet interface-list port-channel port-channel-number-list}</code>	Enables forwarding of all multicast packets on a port.

The following is an example of the CLI commands:

```
Console # show bridge multicast filtering
```

```
Filtering: Enabled
```

```
VLAN: 1
```

```
Port Forward-All
```

```
Static Status
```

```
-----
```

```
1/e1 Forbidden Filter
```

```
1/e2 Forward Forward(s)
```

```
1/e3 - Forward(s)
```

Enabling IGMP Snooping

The **IGMP Snooping** page allows network managers to add IGMP members. To open the **IGMP Snooping** page:

1. Click **Switch > Multicast Support > IGMP Snooping** in the Tree View. The **IGMP Snooping** page opens.

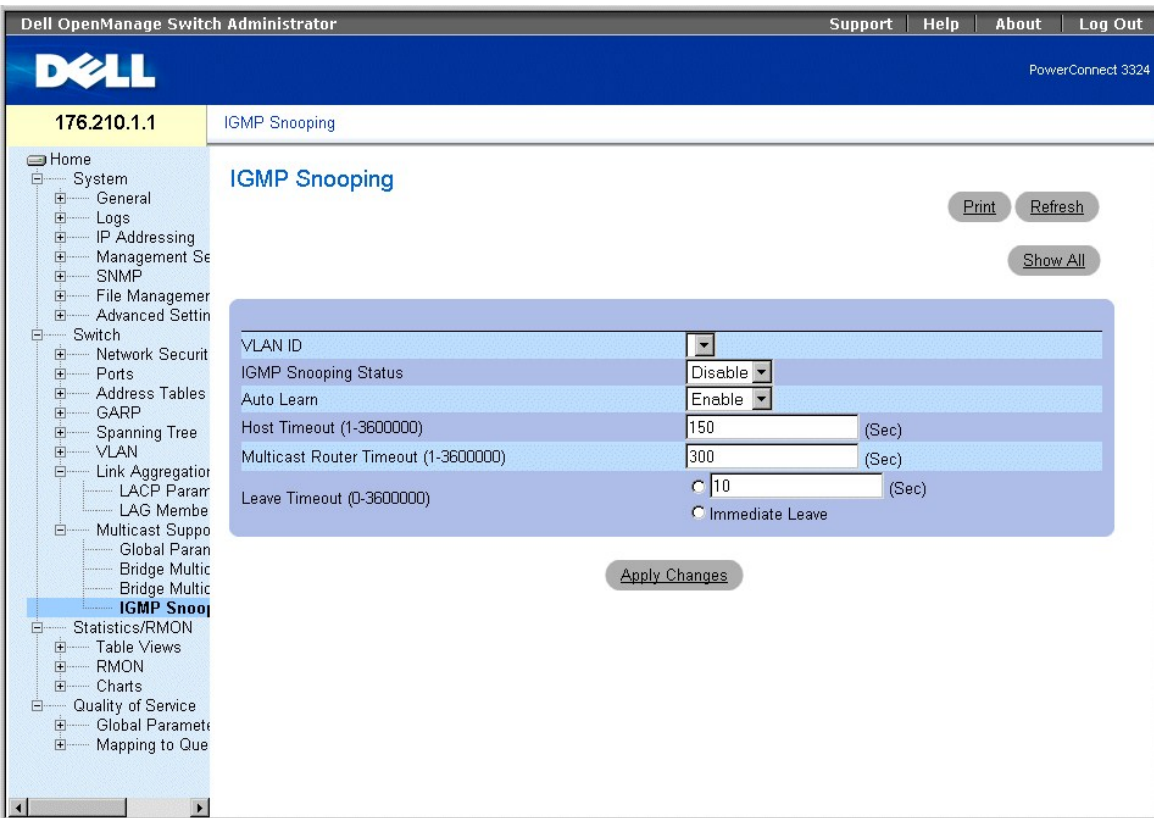

IGMP Snooping Page

The **IGMP Snooping** page contains the following information:

1. **VLAN ID**—Specifies the VLAN ID.
1. **IGMP Snooping Status**—Enables IGMP snooping on the device. The possible field values are:
 - o **Enable**—Enables IGMP snooping on the device.
 - o **Disable**—Disables IGMP snooping on the device.
1. **Auto Learn**—Enables automatically learning new multicast group members. The possible field values are:
 - o **Enable**—Enables automatically learning new multicast group members.
 - o **Disable**—Disables automatically learning new multicast group members.
1. **Host Timeout (1-3600000)**—Indicates the amount of time before an IGMP snooping entry is aged out. The default time is **150** seconds.
1. **Multicast Router Timeout (1-3600000)**—Indicates the amount of time before aging out an Multicast Router entry. The default value is **300** seconds.
1. **Leave Time Out (1-3600000)**—Specifies the amount of time in seconds after a port leave message is received before the entry is aged out. The possible field values are:
 - o **User-Defined**—Indicates the user-defined Leave Timeout period.
 - o **Immediate Leave**—Specifies an immediate Leave Timeout period.

Displaying the IGMP Snooping Table:

1. Open the **IGMP Snooping** page.
2. Click **Show All**. The **IGMP Snooping Table** opens.

IGMP Snooping Table

VLAN ID	IGMP Status	Auto Learn	Host Timeout	MRouter Timeout	Leave Timeout
1	Enable	Enable			

Apply Changes

IGMP Snooping Table

Configuring IGMP Snooping with CLI Commands

The following table summarizes the equivalent CLI commands for configuring IGMP Snooping as displayed in the **IGMP Snooping** page.

CLI Command	Description
<code>ip igmp snooping</code>	Enables Internet Group Management Protocol (IGMP) snooping a specific VLAN.
<code>ip igmp snooping mrouter learn-pim-dvmrp</code>	Enables automatic learning of Multicast router ports in the context of a specific VLAN.
<code>ip igmp snooping host-time-out <i>time-out</i></code>	Configures the host-time-out.
<code>ip igmp snooping mrouter-time-out <i>time-out</i></code>	Configures the mrouter-time-out.
<code>ip igmp snooping leave-time-out { <i>time-out</i> immediate-leave }</code>	Configures the leave-time-out.
<code>show ip igmp snooping mrouter [interface <i>vlan-id</i>]</code>	Displays information on dynamically learned multicast router interfaces.

The following is an example of the CLI commands:

```
Console (config)# interface vlan 2

Console (config-if)# ip igmp snooping

Console (config-if)# ip igmp snooping mrouter learn-pim-dvmrp

Console (config-if)# ip igmp snooping host-time-out 300

Console (config-if)# ip igmp snooping mrouter-time-out 300

Console (config-if)# exit

Console (config)# interface vlan 2

Console (config-if)# ip igmp snooping leave-time-out 60

Console (config-if)# exit

Console (config)# exit

Console # show igmp snooping mrouter interface 1000
```

VLAN Ports

200 1/e1, 2/e1

[Back to Contents Page](#)

[Back to Contents Page](#)

Configuring System Information

Dell™ PowerConnect™ 3324/3348 User's Guide

- [Defining General Device Information](#)
- [Managing Logs](#)
- [Defining Device IP Addresses](#)
- [Managing Device Security](#)
- [Defining SNMP Parameters](#)
- [Managing Files](#)
- [Defining Advanced Settings](#)

This section provides information about defining system parameters including security features, downloading device software, and resetting the device. To open the **System** page:

- 1 Click **System** in the Tree View. The **System** page opens.

The screenshot displays the Dell OpenManage Switch Administrator web interface. At the top, there is a navigation bar with 'Support', 'Help', 'About', and 'Log Out' links. The main header shows the Dell logo and 'PowerConnect 3324'. Below the header, the IP address '176.210.1.1' is displayed. The left sidebar contains a tree view with 'System' selected. The main content area shows the 'System' page with a network diagram and a list of components. The network diagram consists of two rows of port status indicators. The top row has 47 ports, and the bottom row has 24 ports. A 'Component' list is shown below the diagram, with 'General' selected.

Click on the Component item to view its details.

Component
General
Logs
IP Addressing
Management Security
SNMP
File Management
Advanced Settings

System Page

Defining General Device Information

The **General** page contains links to pages that allow network managers to configure device parameters, including:

- 1 [Viewing the Asset Page](#)
- 1 [Viewing System Health Information](#)

1 [Viewing the Versions Page](#)

1 [Resetting the Device](#)

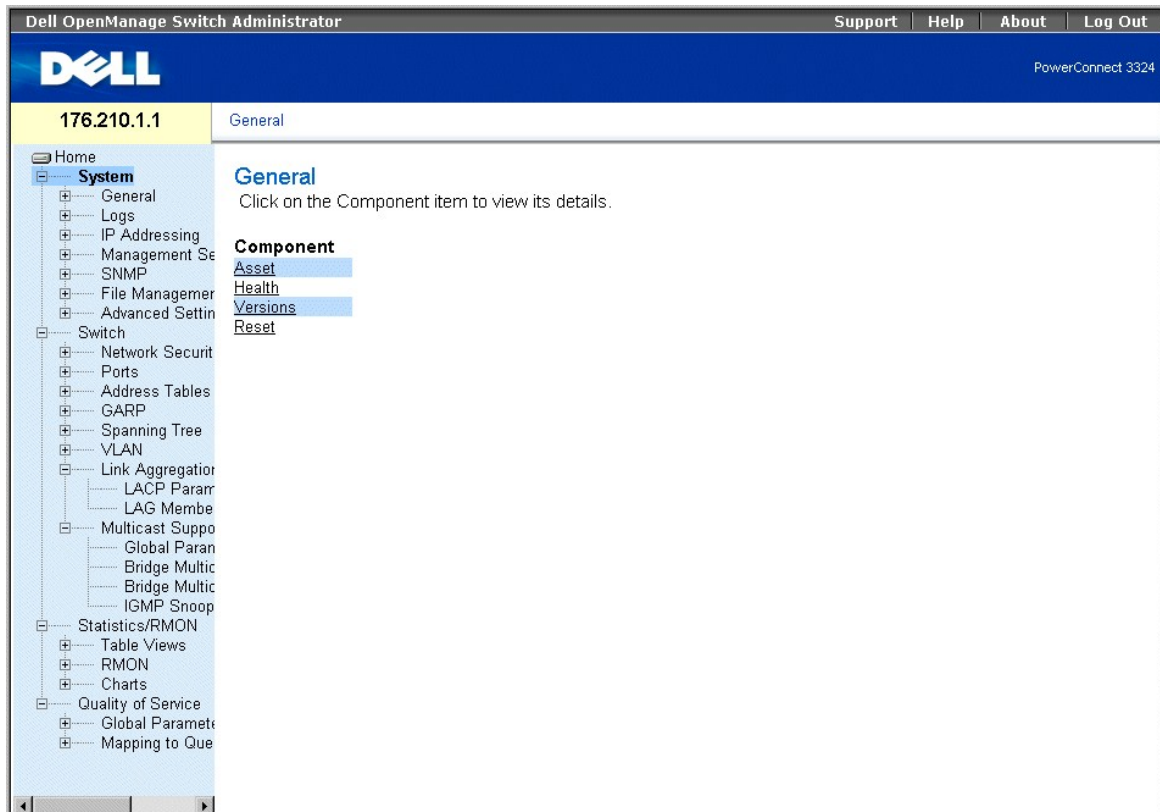

General Page

Viewing the Asset Page

The **Asset** page contains parameters for configuring general device information, including the system name, location, and contact, the system MAC Address, System Object ID, date, time, and System Up Time. To open the **Asset** page:

- 1 Click **System** > **General** > **Asset** in the Tree View. The **Asset** page opens.

Dell OpenManage Switch Administrator Support Help About Log Out

PowerConnect 3324

176.210.1.1 Asset

- Home
- System
 - General
 - Logs
 - IP Addressing
 - Management Se
 - SNMP
 - File Managemer
 - Advanced Settin
- Switch
 - Network Securit
 - Ports
 - Address Tables
 - GARP
 - Spanning Tree
 - VLAN
 - Link Aggregator
 - LACP Param
 - LAG Membe
 - Multicast Suppo
 - Global Param
 - Bridge Multic
 - Bridge Multic
 - IGMP Snoop
- Statistics/RMON
 - Table Views
 - RMON
 - Charts
- Quality of Service
 - Global Parametr
 - Mapping to Que

Asset

Print Refresh

System Name	DELL Switch
System Contact	spk
System Location	R&D
MAC Address	00-10-B5-F4-00-01
Sys Object ID	
Date	11/10/02 (MM/DD/YY)
Time	09:30:00 (HH:MM:SS)
System Up Time	0 d 0 h 0 m 2 s

Unit No.	Service Tag	Asset Tag	Serial No.
1			

[Telnet](#) - Connect to textual user interface

[Apply Changes](#)

Asset Page

The **Asset** page contains the following fields:

- 1 **System Name**—Defines the user-defined device name.
- 1 **System Contact**—Specifies the name of the contact person.
- 1 **System Location**—Indicates the location where the system is currently running.
- 1 **MAC Address**—Specifies the switch MAC address.
- 1 **Sys Object ID**—Identifies the OID of the MIB.
- 1 **Date (MM/DD/YY)**—Indicates the current date. The format is month, day, year; for example, 11/10/02 is November 10, 2002.
- 1 **Time (HH:MM:SS)**—Specifies the time. The format is hour, minute, second; for example, 20:12:03 is twelve minutes and three seconds past eight in the evening.
- 1 **System Up Time**—Specifies the amount of time since the last device reset. The system time is displayed in the following format: Day, Hour Minutes, and Seconds. For example, 41 days 2 hours 22 minutes 15 seconds.
- 1 **Unit No.**—Indicates the stacking unit number.
- 1 **Service Tag**—Indicates the service reference number used when servicing the device.
- 1 **Asset Tag**—Specifies the user-defined device reference.
- 1 **Serial No.**—Indicates the serial number of the device.

Defining system information:

1. Open the **Asset** page.
2. Define the **System Name**, **System Contact**, **System Location**, **Date**, **Asset Tag**, and **Time** fields.
3. Click **Apply Changes**. The system parameters are defined, and the device is updated.

Initiating a Telnet Session:

1. Open the **Asset** page.

2. Click **Telnet**. A Telnet session is initiated.

Configuring Device Information Using the CLI Commands

The following table summarizes the equivalent CLI commands for viewing fields displayed in the **Asset** page.

CLI Command	Description
<code>hostname <i>name</i></code>	Specifies or modifies the device host name.
<code>snmp-server contact <i>text</i></code>	Sets up a system contact.
<code>snmp-server location <i>text</i></code>	Enters information on where the device is located.
<code>clock set <i>hh:mm:ss day month year</i></code>	Manually sets the system clock and date. Note the different date format.
<code>show clock</code>	Displays the time and date from the system clock.
<code>show system id</code>	Displays the service tag information.
<code>show system</code>	Displays system information.
<code>asset tag</code>	Displays the device asset tag.

The following is an example of the CLI commands:

```
Console (config)# hostname dell
```

```
Console (config)# snmp-server contact Dell_Tech_Supp
```

```
Console (config)# snmp-server location New_York
```

```
Console (config)# exit
```

```
Console # exit
```

```
Console (config)# asset-tag lqwepot
```

```
Console> clock set 13:32:00 7 Mar 2002
```

```
Console> show clock
```

```
13:32:00 7 Mar 2002
```

```
console# show system
```

```
System Description: Ethernet Stackable Switching System
```

```
System Up Time (days,hour:min:sec): 0,00:30:58
```

```
System Contact: Dell_Tech_Supp
```

System Name: dell

System Location: New_York

MAC Address: 00:00:b0:22:33:44

Sys Object ID: 1.3.6.1.4.1.674.10895.3004

Power supply Source Status

Internal Power Supply Internal redundant OK unit1

External Power Supply External OK unit1

Internal PowerSupply Internal redundant OK unit2

External PowerSupply External OK unit2

Internal PowerSupply Internal redundant OK unit3

External PowerSupply External OK unit3

Internal PowerSupply Internal redundant OK unit6

External PowerSupply External OK unit6

Viewing System Health Information



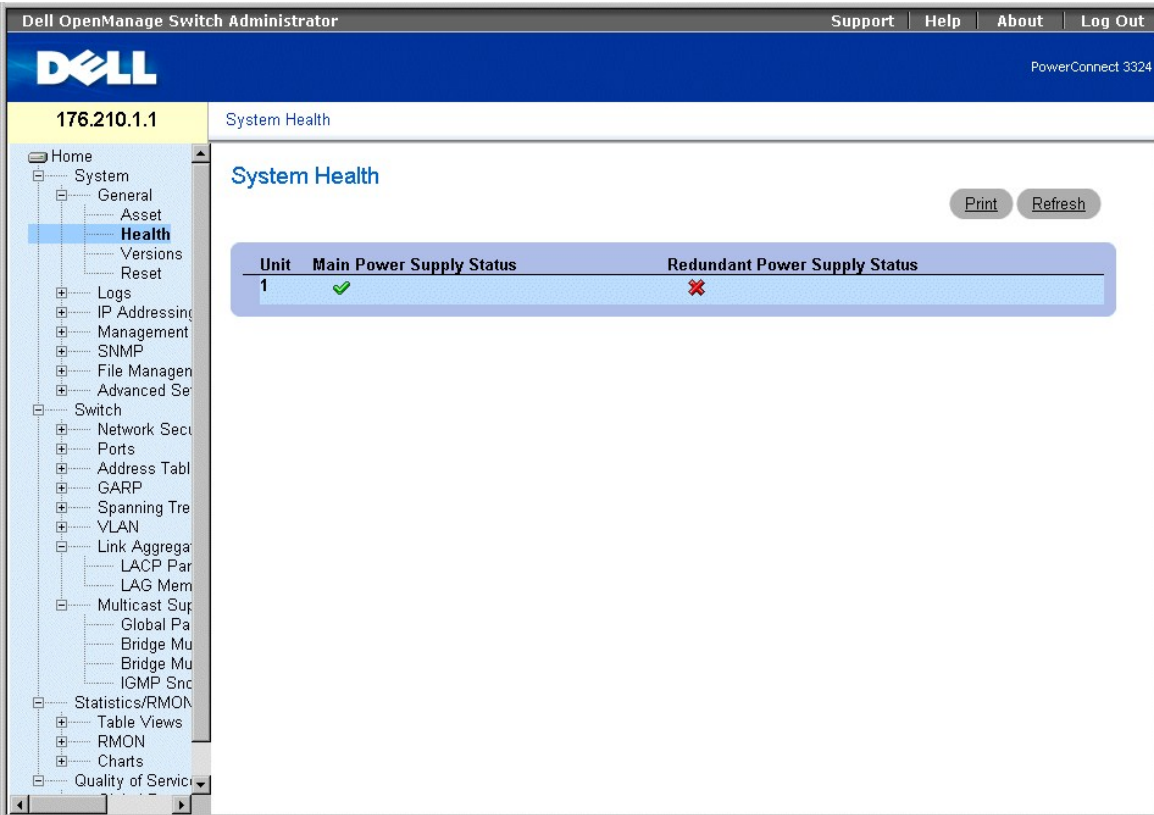

The **System Health** page physical device hardware information. To open the **System Health** page:

- 1 Click **System** > **General** > **Health** in the Tree View. The **System Health** page opens.



System Health Page

The **System Health** page contains the following fields:

- 1 **Unit**—Indicates the stacking unit number.
- 1 **Main Power Supply Status**—Indicates the main power supply state. The possible field values are:
 - o  —Indicates the main power supply is operating normally for the specified unit.
 - o  —Indicates the main power supply is not operating normally for the specified unit.
 - o **Not Present**—Indicates that the power supply is not present for the specified unit.
- 1 **Redundant Power Supply Status**—Indicates the redundant power supply state. The possible field values are:
 - o  —Indicates the redundant power supply is operating normally for the specified unit
 - o  —Indicates the redundant power supply is not operating normally for the specified unit.
 - o **Not Present**—Indicates that the power supply is not present for the specified unit.

Viewing System Health Information Using the CLI Commands

The following table summarizes the equivalent CLI commands for viewing fields displayed in the **System Health** page.

CLI Command	Description
<code>show system</code>	Displays system information.

The following is an example of the CLI commands:

Console> show system

System Description: Ethernet Stackable Switching System

System Up Time (days,hour:min:sec): 0,00:08:56

System Contact: Dell_Tech_Supp

System Name: dell

System Location: New_York

Viewing the Versions Page

The **Versions** page contains information about the hardware and software versions currently running. To open the **Versions** page:

1. Click **System** > **General** > **Versions** in the Tree View. The **Versions** page opens.

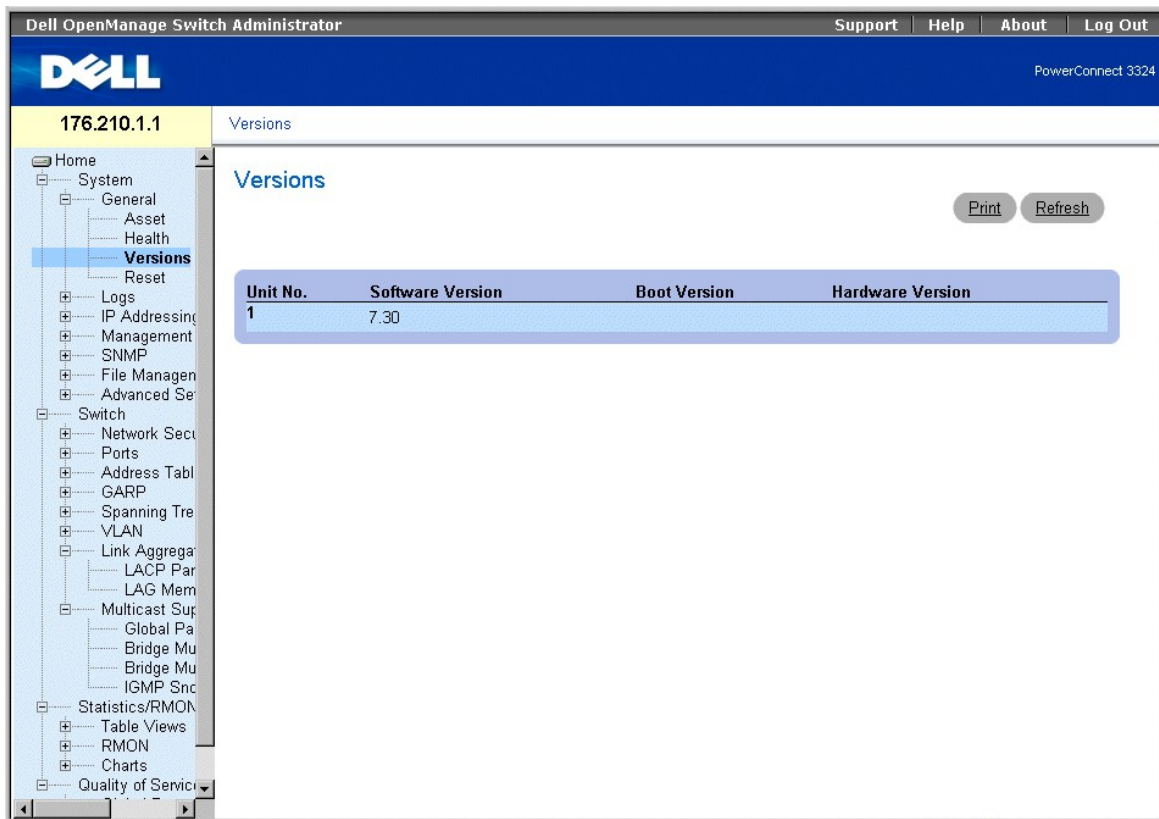

The screenshot shows the Dell OpenManage Switch Administrator interface. The top navigation bar includes links for Support, Help, About, and Log Out. The main content area is titled "Versions" and contains a table with the following data:

Unit No.	Software Version	Boot Version	Hardware Version
1	7.30		

Versions Page

The **Versions** page contains the following information:

- 1 **Unit No.**—Indicates the stacking unit number.
- 1 **Software Version**—Displays the current software version running on a specific stacking unit.
- 1 **Boot Version**—Displays the current Boot version running on a specific stacking unit.
- 1 **Hardware Version**—Displays the current hardware versions running on a specific stacking unit.

Displaying Device Versions using the CLI

The following table summarizes the equivalent CLI commands for viewing fields displayed in the **Versions** page.

CLI Command	Description
show version	Displays the system version information.

The following is an example of the CLI commands:

```
Console> show version

SW version 1.0.0.01 (date 14-Feb-2003 time 14:42:16 )

Boot version 1.30.11 ( date 27-Jan-2003 time 10:06:02 )

HW version 01.01.01
```

Resetting the Device

The **Reset** page allows users to reset the device from a remote location. To open the **Reset** page:

- 1 Click **System** > **General** > **Reset** in the Tree View. The **Reset** page opens.

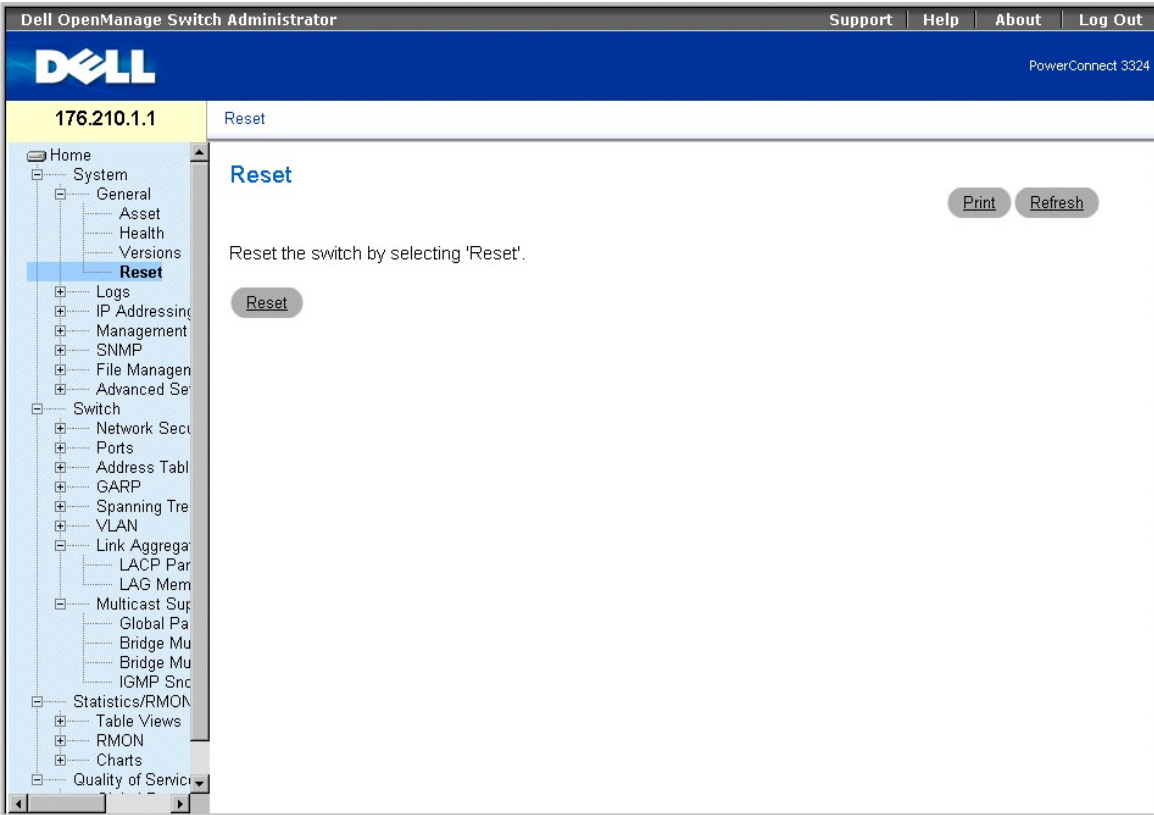

Reset Page

 **NOTE:** Save all changes to the **Running Configuration** file before resetting the device to prevent the current device configuration from being lost. For more information about saving Configuration files, see "[Managing Files](#)".

Resetting the device:

1. Open the **Reset** page.
2. Click **Reset**. A confirmation message displays:



Device Reset Confirmation Message

3. Click **OK**. The device is reset. After the device is reset, the user is prompted for a user name and password.

Resetting the Device Using the CLI

The following table summarizes the equivalent CLI commands for viewing fields displayed in the **Reset** page.

CLI Command	Description
reload	Reloads the operating system.

The following is an example of the CLI commands:

```
Console >reload
```

This command will reset the whole system and disconnect your current

session. Do you want to continue (y/n) [n] ?

Managing Logs

The **Logs** page contains links to various log pages. To open the **Logs** page:

- 1 Click **System** > **Logs** in the Tree View. The **Logs** page opens.

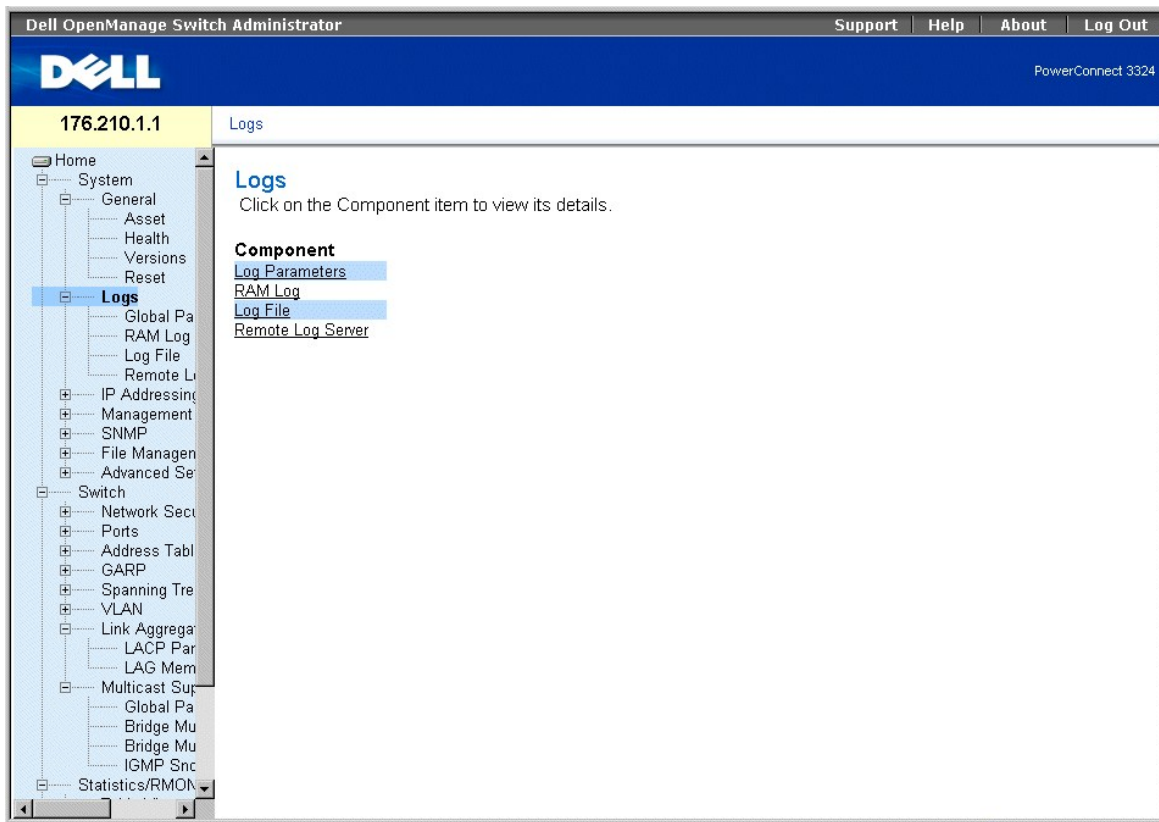

Logs Page

The **Logs** page contains links to the following pages:

- 1 [Defining Global Log Parameters](#)
- 1 [Displaying RAM Log Table](#)
- 1 [Displaying the Log File Table](#)
- 1 [Viewing the Remote Log Server Settings Page](#)

Defining Global Log Parameters

The System Logs enable you to view significant events in real time and keep a record of these events for later use. This feature provides the ability to log and manage events and report errors.

Event messages have a unique format, as per the SYSLOG RFC recommended message format for all error reporting; for example, Syslog+ local device reporting. Messages are assigned a severity code and include a message mnemonic, which identifies the source application generating the message. Messages are filtered based on their urgency or relevancy. The severity of each message determines the set of event logging devices to which messages are sent for each event logging device. The following table contains the Log Severity Levels:

Severity Type	Severity Level	Description
Emergency	0	Indicates that the system is not functioning.
Alert	1	Indicates that the system needs immediate attention.
Critical	2	Indicates that the system is in a critical state.
Error	3	Indicates that a system error has occurred.
Warning	4	Indicates that a system warning has occurred.
Notice	5	Indicates that the system is functioning properly, but system notice has occurred.
Informational	6	Provides device information.
Debug	7	Provides detailed information about the log.

Log Severity Levels

The **Global Log Parameters** page enables you to define which events are recorded to which logs. It contains fields for enabling logs globally and parameters for defining log parameters. The Severity log messages are listed from the highest to the lowest severity. To open the **Global Log Parameters** page:

- 1 Click **System > Logs > Global Parameters** in the Tree View. The **Global Log Parameters** page opens.

The screenshot shows the Dell OpenManage Switch Administrator interface. The top navigation bar includes 'Support', 'Help', 'About', and 'Log Out'. The main content area is titled 'Global Log Parameters' and features a 'Logging' dropdown menu set to 'Enable'. Below this is a table for configuring log severity levels. The table has columns for 'Severity', 'Console', 'RAM Logs', and 'Log File'. The rows represent severity levels from Emergency to Debug. Checkmarks indicate which destinations are selected for each severity level. An 'Apply Changes' button is located at the bottom of the table.

Severity	Console	RAM Logs	Log File
Emergency	<input checked="" type="checkbox"/>	<input checked="" type="checkbox"/>	<input checked="" type="checkbox"/>
Alert	<input checked="" type="checkbox"/>	<input checked="" type="checkbox"/>	<input checked="" type="checkbox"/>
Critical	<input checked="" type="checkbox"/>	<input checked="" type="checkbox"/>	<input checked="" type="checkbox"/>
Error	<input checked="" type="checkbox"/>	<input checked="" type="checkbox"/>	<input checked="" type="checkbox"/>
Warning	<input checked="" type="checkbox"/>	<input checked="" type="checkbox"/>	<input type="checkbox"/>
Notice	<input checked="" type="checkbox"/>	<input checked="" type="checkbox"/>	<input type="checkbox"/>
Informational	<input checked="" type="checkbox"/>	<input checked="" type="checkbox"/>	<input type="checkbox"/>
Debug	<input type="checkbox"/>	<input type="checkbox"/>	<input type="checkbox"/>

Global Log Parameters Page

The **Global Log Parameters** page contains the following fields:

- 1 **Logging**—Enables device global logs for Cache, File, and Server Logs. Console logs are enabled by default and cannot be disabled. The possible field values are:
 - o **Enable**—Enables saving logs in Cache (RAM), File (FLASH), and an External Server.
 - o **Disable**—Disables saving logs. Console logs cannot be disabled.
- 1 **Severity**—The following are the available severity logs:
 - o **Emergency**—Indicates the highest warning level. If the device is down or not functioning properly, an emergency log message is saved to the specified logging location.
 - o **Alert**—Indicates the second highest warning level. An alert log is saved if there is a serious device malfunction; for example, if all device features are down.
 - o **Critical**—Indicates the third-highest warning level. A critical log is saved when a critical device malfunction occurs; for example, if two device ports are not functioning while the rest of the device ports remain functional.
 - o **Error**—Indicates that a device error has occurred; for example, if a single port is offline.
 - o **Warning**—Indicates the lowest level of a device warning. The device is functioning, but an operational problem has occurred.
 - o **Notice**—Provides the network administrators with device information.
 - o **Informational**—Provides device information.
 - o **Debug**—Provides detailed information about the log. If a Debug error occurs, contact Dell Online Technical Support (www.support.dell.com).

 **NOTE:** When a severity level is selected, all severity level choices above the selection are selected automatically.

The **Global Log Parameters** page also contains check boxes that correspond to a distinct logging system:

- 1 **Console**—Indicates the minimum severity level from which logs are sent to the console.
- 1 **RAM Logs**—Indicates the minimum severity level from which logs are sent to the Log File kept in RAM (Cache).
- 1 **Log File**—Indicates the minimum severity level from which logs are sent to the Log File kept in FLASH memory.

Enabling Logs:

1. Open the **Global Log Parameters** page.
2. Select **Enable** in the **Logging** drop-down list.
3. Select the log type and log severity in the **Global Log Parameters** check boxes.
4. Click **Apply Changes**. The log settings are saved, and the device is updated.

Enabling Logs Using CLI Commands

The following table summarizes the equivalent CLI commands for viewing fields displayed in the **Global Log Parameters** page.

CLI Command	Description
<code>logging on</code>	Enables error message logging.
<code>logging ip-address [port port] [severity level] [facility facility] [description text]</code>	Logs messages to a syslog server. For a list of the Severity levels, see " Log Severity Levels ".
<code>logging console level</code>	Limits messages logged to the console based on severity.
<code>logging buffered level</code>	Limits syslog messages displayed from an internal buffer (RAM) based on severity.
<code>logging file level</code>	Limits syslog messages sent to the logging file based on severity.
<code>clear logging</code>	Clears logs.

The following is an example of the CLI commands:

```
Console (config)# logging on
```

```
Console (config)# logging console errors
```

```
Console (config)# logging buffered debugging
```

```
Console (config)# logging file alerts
```

```
Console (config)# clear logging
```

Displaying RAM Log Table

The **RAM Log Table** contains information about log entries kept in RAM, including the time the log was entered, the log severity, and a description of the log. To open the **RAM Log Table** page:

1. Click **System > Logs > RAM Log** in the Tree View. The **RAM Log Table** page opens.

The screenshot shows the Dell OpenManage Switch Administrator interface. The top navigation bar includes 'Support', 'Help', 'About', and 'Log Out'. The main content area is titled 'RAM Log Table' and contains a table with the following data:

Log Index	Log Time	Severity	Description
1	10:12:56	Informational	

Buttons for 'Print', 'Refresh', and 'Clear Log' are visible on the page.

RAM Log Table Page

The **RAM Log Table** page contains the following fields:

1. **Log Index**—Indicates the log number in the **RAM Log Table**.
1. **Log Time**—Specifies the time at which the log was entered in the **RAM Log Table**.
1. **Severity**—Specifies the log severity.
1. **Description**—Displays the user-defined log description.

Removing Log Information:

1. Open the **RAM Log Table** page.
2. Click **Clear Log**. The log information is removed from the **RAM Log Table/Log File Table**, and the device is updated.

Viewing the RAM Log Table Using the CLI Commands

The following table summarizes the equivalent CLI commands for viewing fields displayed in the **RAM Log Table** page.

CLI Command	Description
show logging	Displays the state of logging and the syslog messages stored in the internal buffer.
clear logging	Clears logs.

The following is an example of the CLI commands:

```
Console # show logging
```

```
Console logging: level debugging. Console Messages: 0 Dropped (severity).
```

```
Buffer logging: level debugging. Buffer Messages: 11 Logged, 200 Max.
```

```
File logging: level notifications. File Messages: 0 Dropped (severity).
```

```
Syslog server 192.180.2.27 logging: errors. Messages: 6 Dropped (severity).
```

```
Syslog server 192.180.2.28 logging: errors. Messages: 6 Dropped (severity).
```

```
2 messages were not logged (resources)
```

```
Buffer log:
```

```
11-Aug-2002 15:41:43: %LINK-3-UPDOWN: Interface FastEthernet0/0, changed state to up
```

```
11-Aug-2002 15:41:43: %LINK-3-UPDOWN: Interface Ethernet1/e0, changed state to up
```

```
11-Aug-2002 15:41:43: %LINK-3-UPDOWN: Interface Ethernet1/e1, changed state to up
```

```
11-Aug-2002 15:41:43: %LINK-3-UPDOWN: Interface Ethernet1/e2, changed state to up
```

```
11-Aug-2002 15:41:43: %LINK-3-UPDOWN: Interface Ethernet1/e3, changed state to up
```

```
11-Aug-2002 15:41:43: %SYS-5-CONFIG_I: Configured from memory by console
```

```
11-Aug-2002 15:41:39: %LINEPROTO-5-UPDOWN: Line protocol on Interface FastEthernet0/0, changed state to up
```

```
11-Aug-2002 15:41:39: %LINEPROTO-5-UPDOWN: Line protocol on Interface Ethernet1/e0, changed state to down
```

```
11-Aug-2002 15:41:39: %LINEPROTO-5-UPDOWN: Line protocol on Interface Ethernet1/e1, changed state to down
```

```
11-Aug-2002 15:41:39: %LINEPROTO-5-UPDOWN: Line protocol on Interface Ethernet1/e2, changed state to down
```

```
11-Aug-2002 15:41:39: %LINEPROTO-5-UPDOWN: Line protocol on Interface Ethernet1/e3, changed state to down
```

```
Console # clear logging
```

```
clear logging buffer [confirm]
```

```
Console #
```

```
Console # clear logging file
```

```
clear logging buffer [confirm]
```

```
Console #
```

Displaying the Log File Table

The **Log File Table** contains information about log entries saved to the Log File in FLASH, including the time the log was entered, the log severity, and a description of the log message. To open the **Log File Table** page:

1. Click **System > Logs > Log File** in the Tree View. The **Log File Table** page opens.

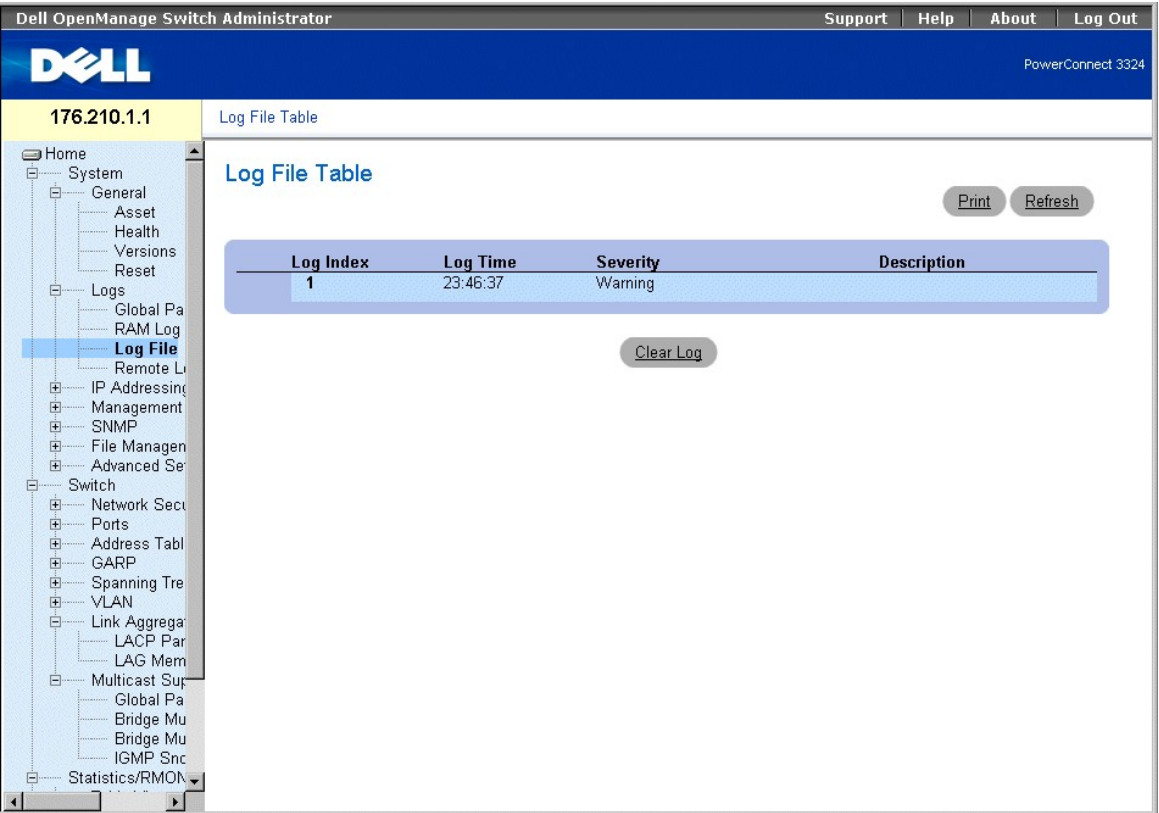

Log File Table

The **Log File Table** contains the following fields:

- 1 **Log Index**—Indicates the log number in the **Log File Table**.
- 1 **Log Time**—Specifies the time at which the log was entered in the **Log File Table**.
- 1 **Severity**—Specifies the log severity.
- 1 **Description**—Displays the log message text.

Displaying the Log File Table Using the CLI Commands

The following table summarizes the equivalent CLI commands for viewing fields displayed in the **Log File Table**.

CLI Command	Description
show logging file	Displays the state of logging and the syslog messages stored in the logging file.
clear logging	Clears all log files.

The following is an example of the CLI commands:

```

Console # show logging file

Console logging: level debugging. Console Messages: 0 Dropped (severity).

```

Buffer logging: level debugging. Buffer Messages: 11 Logged, 200 Max.

File logging: level notifications. File Messages: 0 Dropped (severity).

Syslog server 192.180.2.27 logging: errors. Messages: 6 Dropped (severity).

Syslog server 192.180.2.28 logging: errors. Messages: 6 Dropped (severity).

2 messages were not logged (resources)

File log:

11-Aug-2002 15:41:43: %LINK-3-UPDOWN: Interface FastEthernet0/0, changed state to up

11-Aug-2002 15:41:43: %LINK-3-UPDOWN: Interface Ethernet1/e0, changed state to up

11-Aug-2002 15:41:43: %LINK-3-UPDOWN: Interface Ethernet1/e1, changed state to up

11-Aug-2002 15:41:43: %LINK-3-UPDOWN: Interface Ethernet1/e2, changed state to up

11-Aug-2002 15:41:43: %LINK-3-UPDOWN: Interface Ethernet1/e3, changed state to up

11-Aug-2002 15:41:43: %SYS-5-CONFIG_I: Configured from memory by console

11-Aug-2002 15:41:39: %LINEPROTO-5-UPDOWN: Line protocol on Interface FastEthernet0/0, changed state to up

11-Aug-2002 15:41:39: %LINEPROTO-5-UPDOWN: Line protocol on Interface Ethernet1/e0, changed state to down

11-Aug-2002 15:41:39: %LINEPROTO-5-UPDOWN: Line protocol on Interface Ethernet1/e1, changed state to down

11-Aug-2002 15:41:39: %LINEPROTO-5-UPDOWN: Line protocol on Interface Ethernet1/e2, changed state to down

11-Aug-2002 15:41:39: %LINEPROTO-5-UPDOWN: Line protocol on Interface Ethernet1/e3, changed state to down

Viewing the Remote Log Server Settings Page

The **Remote Log Server Settings** page contains fields for viewing the available Log Servers. In addition, new log servers can be defined and the severity of the logs sent to each server. To open the **Remote Log Server Settings** page:

- 1 Click **System > Logs > Remote Log Server** in the Tree View. The **Remote Log Server Settings** page opens.

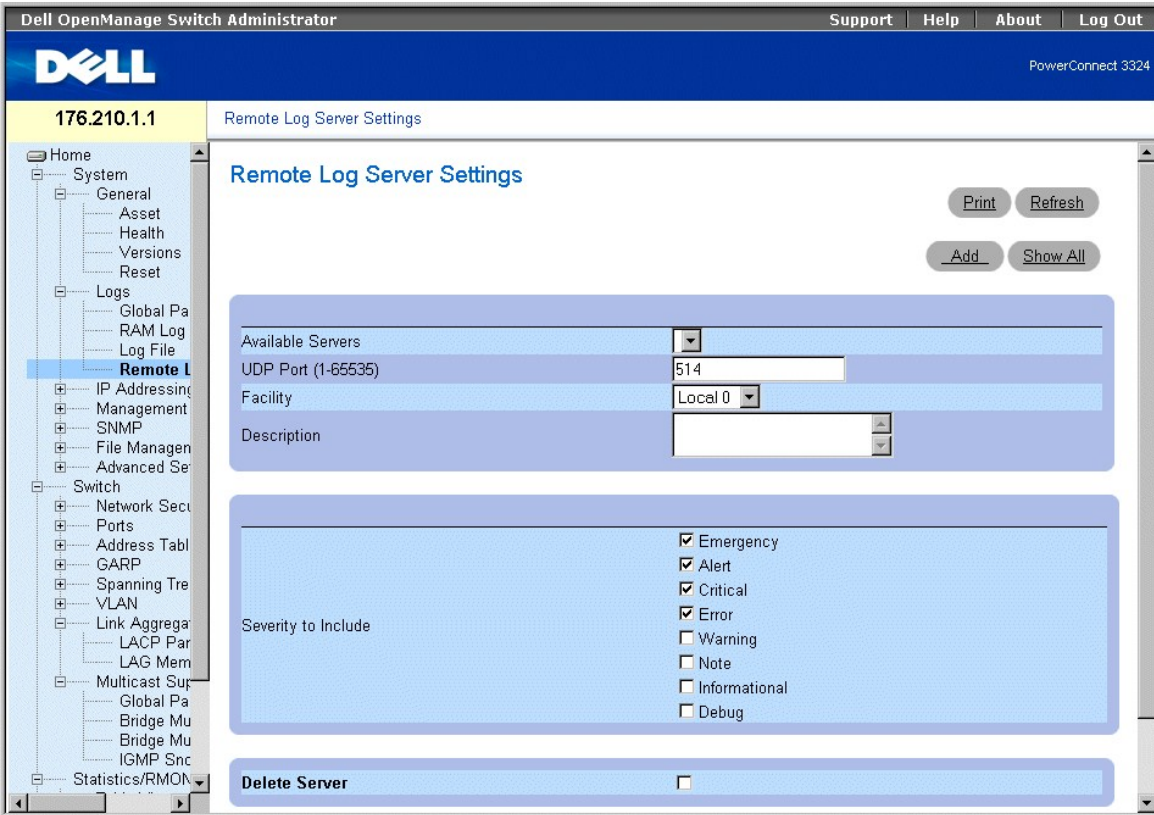

Remote Log Server Settings Page

The **Remote Logs Server Settings** page contains the following fields:

1. **Available Servers**—Contains a list of servers to which logs can be sent.
1. **UDP Port (1-65535)**—Indicates the UDP port to which the logs are sent for the selected server. The possible range is 1 - 65,535. The default value is 514.
1. **Facility**—Indicates the facility mapping level for the selected server. The default value is Local 0. The possible values are:
 - o **Local 0 - Local 7.**
 - o **No Map.**
1. **Description**—Displays the user-defined server description.
1. **Delete Server**—Deletes the currently selected server from the **Available Servers** list. The possible field values are:
 - o **Checked**—Deletes the server from the **Available Servers** list.
 - o **Unchecked**—Maintains the server in the **Available Servers** list.

The **Remote Logs Server Settings** page also contains a severity list. The severity definitions are the same as the severity definitions on the "[Global Log Parameters Page](#)".

Sending logs to a server:

1. Open the **Remote Logs Server Settings** page.
2. Select a server from the **Available Servers** drop-down list.
3. Define the **UDP Port**, **Facility**, and **Description** fields.
4. Select the log severity in the **Severity to Include** check boxes.
5. Click **Apply Changes**. The log settings are saved, and the device is updated.

Defining a new server:

1. Open the **Remote Logs Server Settings** page.
2. Click **Add**. The **Add a Log Server** page opens.

Add a Log Server

New Log Server IP Address	<input type="text"/> (X.X.X.X)
UDP Port (1-65535)	<input type="text" value="514"/>
Facility	<input type="text" value="Level 0"/>
Description	<input type="text"/>
Severity To Include	<input type="checkbox"/> Emergency <input type="checkbox"/> Alert <input type="checkbox"/> Critical <input type="checkbox"/> Error <input type="checkbox"/> Warning <input type="checkbox"/> Note <input type="checkbox"/> Informational <input type="checkbox"/> Debug

[Apply Changes](#)

Add a Log Server Page

In addition to the fields in the **Remote Logs Server Settings** page, the **Add a Log Server** page contains the following field:

- 1. **New Log Server IP Address**—Specifies the IP address of the new Log Server.

To add a log server:

1. Define the **New Log Server IP Address**, **UDP Port**, **Facility**, and **Description** fields, and select the **Severity to Include** check boxes.
2. Click **Apply Changes**. The server is defined and added to the **Available Servers** list.

Displaying the Log Servers Table:

1. Open the **Remote Logs Server Settings** page.
2. Click **Show All**. The **Log Servers Table** page opens.

Log Servers Table

[Refresh](#)

Servers	UDP Port	Facility	Description	Minimum Severity	Remove
1					<input type="checkbox"/>

[Apply Changes](#)

Log Servers Table Page

Removing a Log Server from the **Log Servers Table** page:

1. Open the **Remote Logs Server Settings** page.
2. Click **Show All**. The **Log Servers Table** page opens.
3. Select a **Log Servers Table** entry.
4. Check the **Remove** check box to remove the server(s).
5. Click **Apply Changes**. The **Log Servers Table** entry is removed and the device is updated.

Defining Device IP Addresses

The **IP Addressing** page contains links for assigning interface and default gateway IP addresses and defining ARP and DHCP parameters for the interfaces. To open the **IP Addressing** page:

- 1 Click **System > IP Addressing** in the Tree View. The **IP Addressing** page opens.

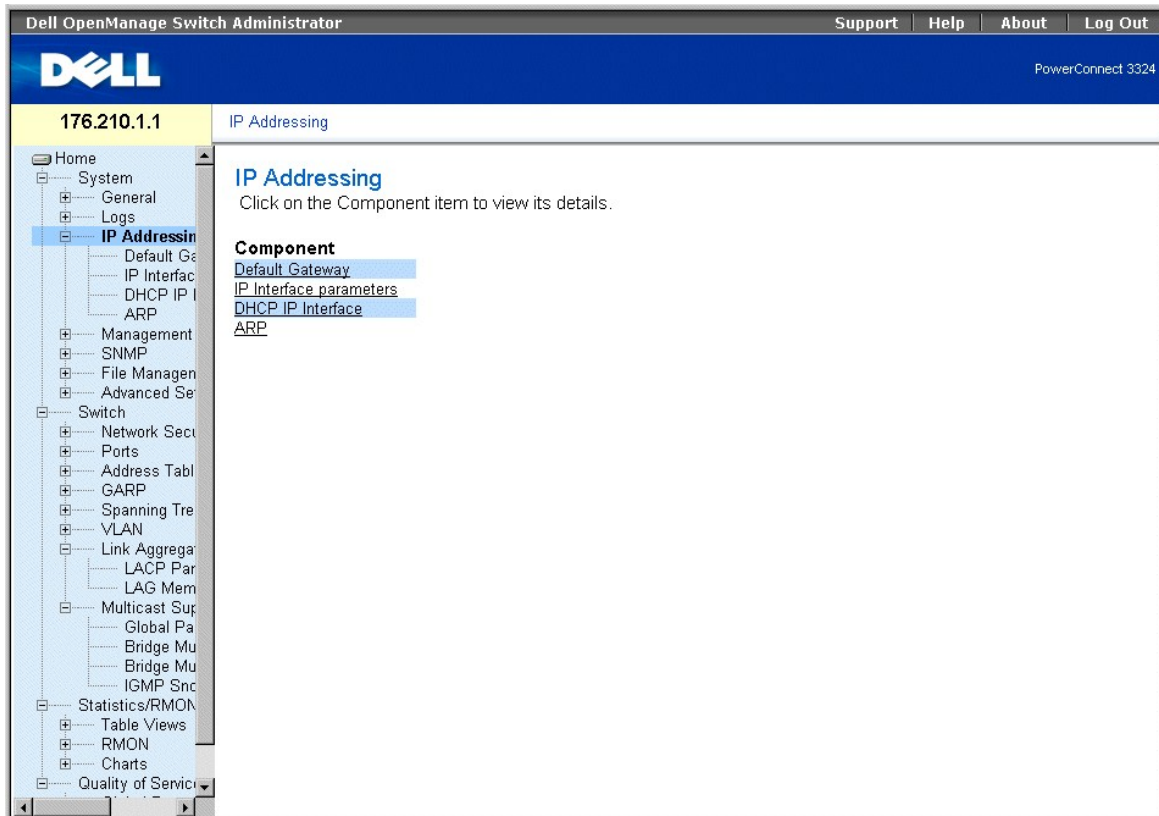

IP Addressing Page

The **IP Addressing** page contains links to the following pages:

- 1 [Defining Default Gateways](#)
- 1 [Defining IP Interfaces](#)
- 1 [Defining DHCP IP Interfaces](#)
- 1 [Configuring ARP](#)

Defining Default Gateways

The **Default Gateway** page allows network managers to assign Gateway devices. Packets are forwarded to the default IP when frames are sent to a remote network. The configured IP address must belong to the same IP address subnet of one of the IP interfaces. To open the **Default Gateway** page:

- 1 Click **System > IP Addressing > Default Gateway** in the Tree View. The **Default Gateway** page opens.

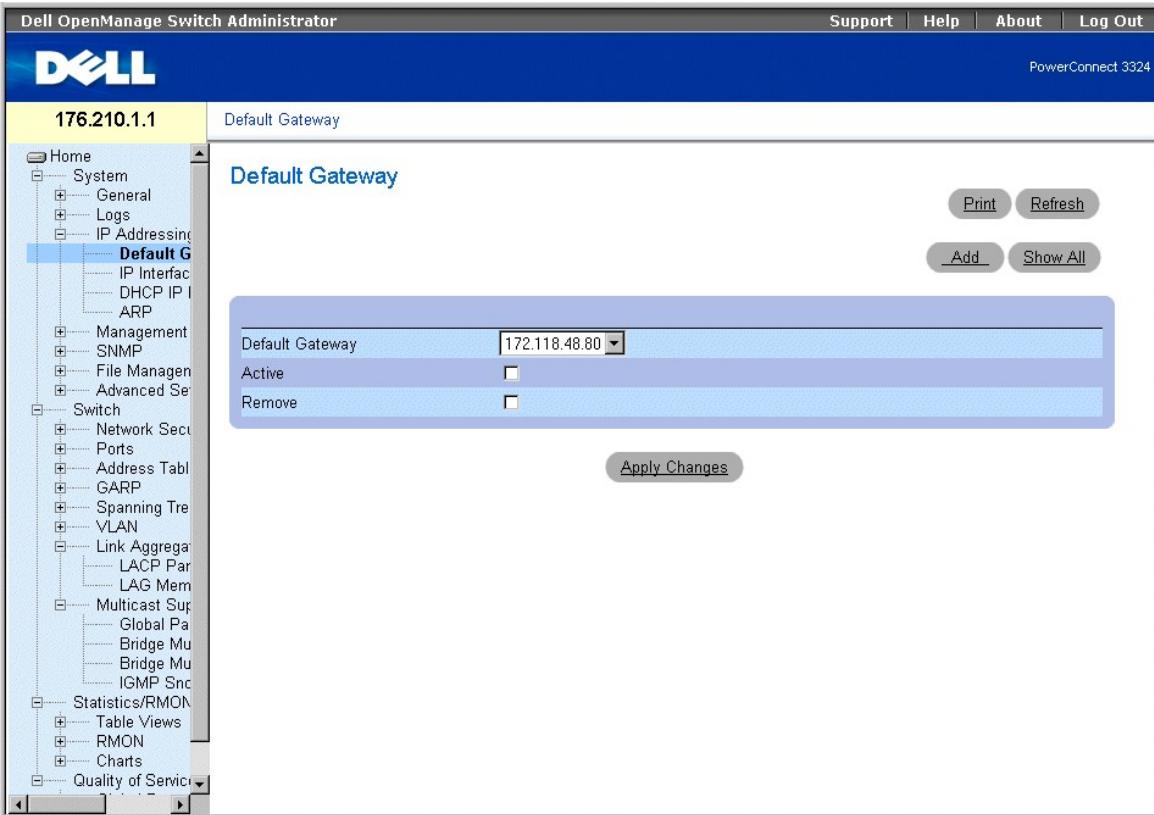

Default Gateway Page

The **Default Gateway** page contains the following fields:

1. **Default Gateway**—Indicates the Gateway device IP address.
1. **Active**—Indicates if the default Gateway device specified in the **Default Gateway** drop-down list is currently active. The possible field values are:
 - o **Checked**—Indicates the Gateway device is currently active.
 - o **Unchecked**—Indicates the Gateway device is not currently active.
1. **Remove**—Removes Gateway devices from the **Default Gateway** drop-down list.
 - o **Checked**—Removes the selected Gateway devices from the **Default Gateway** drop-down list.
 - o **Unchecked**—Maintains Gateway devices in the **Default Gateway** drop-down list.

Selecting a Gateway device:

1. Open the **Default Gateway** page.
2. Select an IP address in the **Default Gateway** drop-down list.
3. Check the **Active** check box.
4. Click **Apply Changes**. The Gateway device is selected, and its status displays in the **Active** field.

Adding a Gateway device:

1. Open the **Default Gateway** page.
2. Click **Add**. The **Add New Default Gateway** page opens.

Add New Default Gateway

Default Gateway IP Address

Set Default Gateway As Active

[Apply Changes](#)

Add New Default Gateway

3. Define the **Default Gateway IP Address** field.

OR

Set the new gateway as active by checking the check box.

4. Click **Apply Changes**. The new default Gateway device is defined, and the device is updated.

Displaying the Default Gateway Table:

1. Open the **Default Gateway** page.
2. Click **Show All**. The **Default Gateway Table** opens.

Default Gateway	Active	Remove
1	<input type="checkbox"/>	

[Apply Changes](#)

Default Gateway Table Page

Removing a Default Gateway device:

1. Open the **Default Gateway** page.
2. Click **Show All**. The **Default Gateway Table** page opens.
3. Select a **Default Gateway Table** entry.
4. Check the **Remove** check box to remove default gateways.
5. Click **Apply Changes**. The Default Gateway Table entry is removed, and the device is updated.

Defining Gateway devices Using the CLI Commands

The following table summarizes the equivalent CLI commands for viewing fields displayed in the **Default Gateway** page.

CLI Command	Description
ip default-gateway ip-address1 [ip-address2.]	Defines a default gateway.
no ip default-gateway [ip-address]	Removes a default gateway.

The following is an example of the CLI commands:

```
Console (config)# ip default-gateway 196.210.10.1
```

```
Console (config)# no ip default-gateway 196.210.10.1
```

Defining IP Interfaces

The **IP Interface Parameters** page contains parameters for assigning IP addresses to interfaces. To open the **IP Interface Parameters** page:

1. Click **System > IP Addressing > IP Interface Parameters** in the Tree View. The **IP Interface Parameters** page opens.

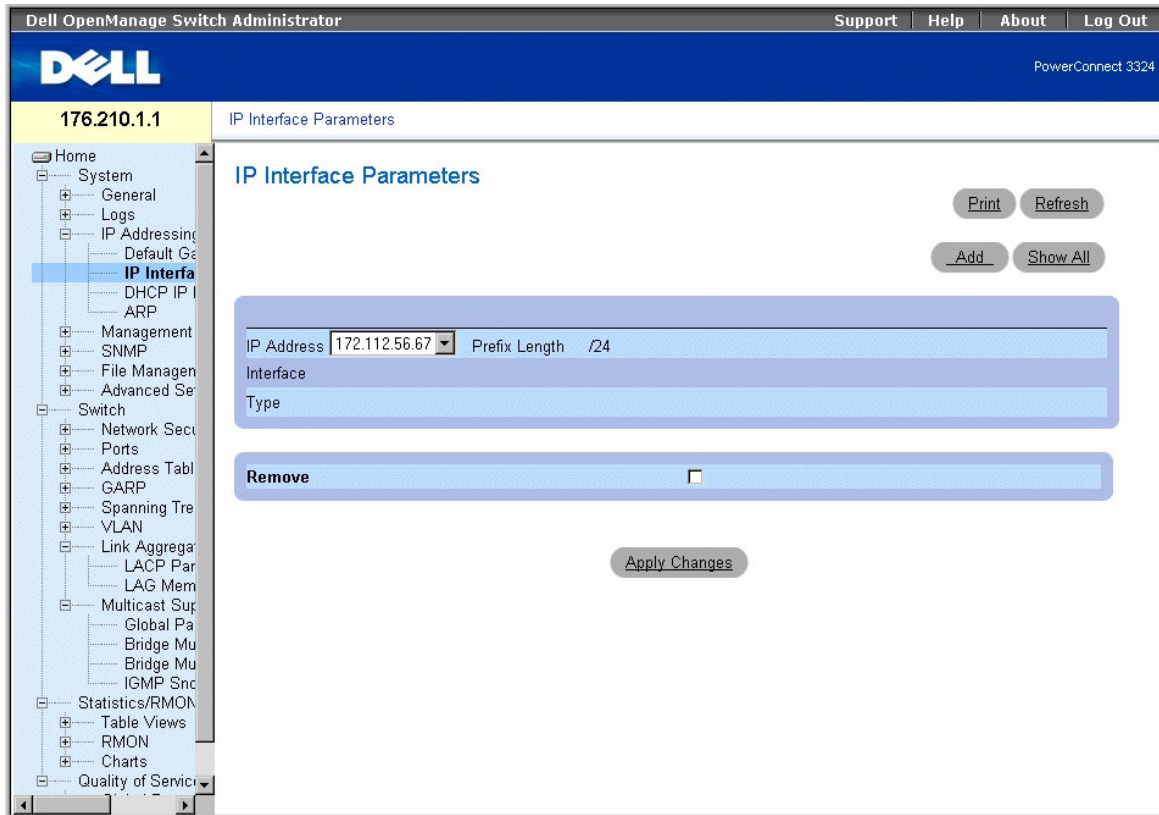

IP Interface Parameters Page

The **IP Interface Parameters** page contains the following fields:

1. **IP Address**—Indicates the list of interface IP address.
1. **Interface**—Specifies the interface type for which the selected IP address is defined. The possible field values are:
 - o **Port**—Indicates that the IP address was assigned to a port.
 - o **LAG**—Indicates that the IP address was assigned to a Link Aggregated Group (LAG).
 - o **VLAN**—Indicates that the IP address was assigned to a VLAN.
1. **Type**—Indicates whether the IP address was defined manually as a static IP address or automatically through DHCP.
1. **Remove**—Removes the selected interface from the **IP Address** drop-down list.
 - o **Checked**—Removes the interface from the **IP Address** drop-down list.
 - o **Unchecked**—Maintains the interface in the **IP Address** drop-down list.

Adding an IP Interface:

1. Open the **IP Interface Parameters** page.
2. Click **Add**. The **Add a Static IP Interface** page opens:

Add a Static IP Interface

IP Address (X.X.X.X) Network Mask (X.X.X.X)
 Prefix Length (/XX)

Interface Port LAG VLAN

[Apply Changes](#)

Add A Static IP Interface Page

3. Define the **IP Address**, **Interface**, **Network Mask**, or the **Prefix Length** fields.
4. Select the interface to which the IP interface will be assigned.
5. Click **Apply Changes**. The new interface is added, and the device is updated.

Displaying the IP Interface Table:

1. Open the **IP Interface Parameters** page.
2. Click **Show All**. The **IP Interface Table** page opens. The **IP Interface Table** contains the same fields as the ["Defining IP Interfaces"](#).

IP Interface Table

	IP Address	Prefix Length	Interface	Type	Remove
1				Static	<input type="checkbox"/>

[Apply Changes](#)

IP Interface Table Page

Deleting IP addresses:

1. Open the **IP Interface** page.
2. Click **Show All**. The **IP Interface Table** page opens.
3. Select an entry in the **IP Interface Table**.
4. Check the **Remove** check box to remove IP addresses.
5. Click **Apply Changes**. The IP address is deleted, and the device is updated.

Defining IP Interfaces Using CLI Commands

The following table summarizes the equivalent CLI commands for viewing fields displayed in the **IP Interface Parameters** page.

CLI Command	Description
<code>ip address ip-address {mask prefix-length}</code>	Sets an IP address.
<code>no ip address [ip-address]</code>	Removes an IP address
<code>show ip interface [ethernet interface-number vlan vlan-id port-channel number]</code>	Displays the usability status of interfaces configured for IP.

The following is an example of the CLI commands:

```
Console (config)# interface vlan 1
```

```
Console (config-if)# ip address 131.108.1.27 255.255.255.0
```

```
Console (config-if)# no ip address 131.108.1.27
```

```
Console (config-if)# exit
```

```
Console# show ip interface vlan 1
```

```
Internet address is 10.7.1.192/24
```

```
console# show ip interface vlan 204
```

```
IP Address Directed Broadcast
```

```
-----
```

```
146.1.0.132/29 disable
```

```
console#
```

Defining DHCP IP Interfaces

The **DCHP IP Interface** page specifies the DHCP client setting for the device per interface.

- 1 Click **System > IP Addressing > DHCP IP Interface** in the Tree View. The **DCHP IP Interface** page opens.

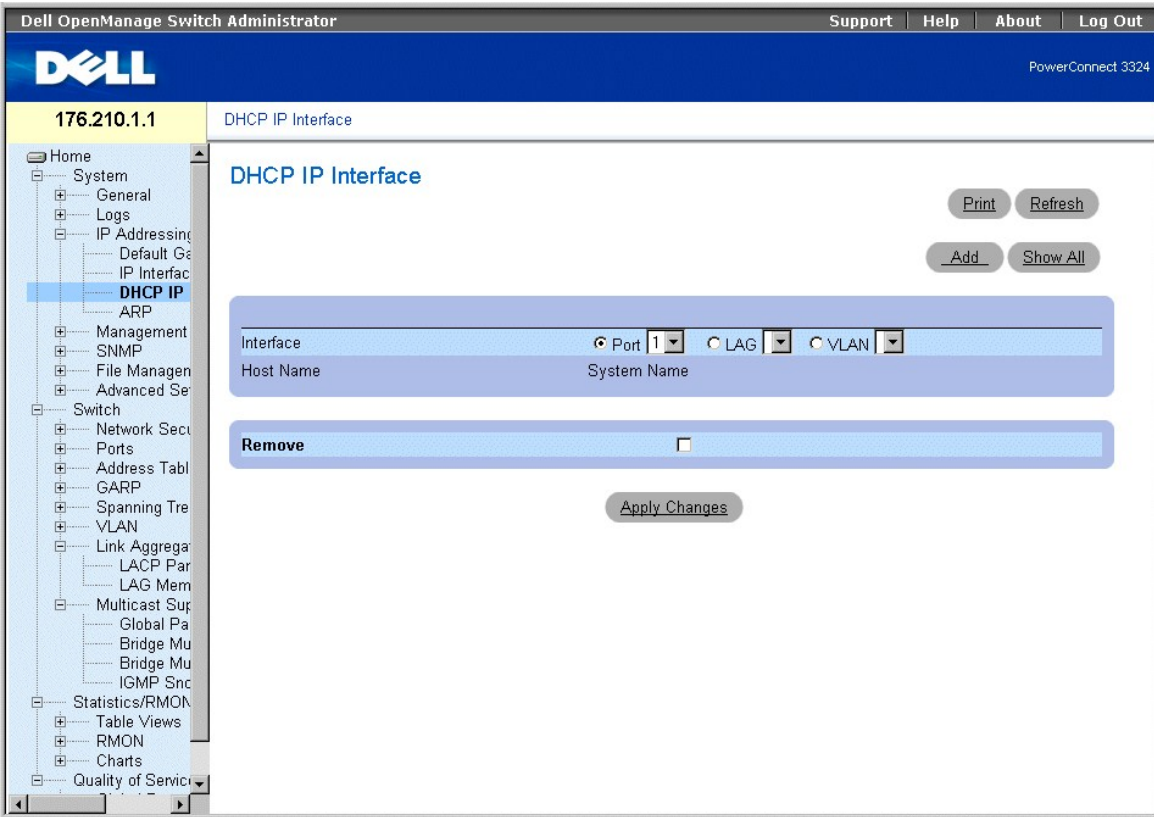

DHCP IP Interface Page

The **DHCP IP Interface** page contains the following fields:

- 1 Interface—Select an interface of the device.
 - o **Port**—Specifies the interface type is a port, and the specific port number for which DHCP client settings are shown.
 - o **LAG**—Specifies the interface type is a LAG, and the specific LAG number for which DHCP client settings are shown.
 - o **VLAN**—Specifies the interface type is a VLAN, and the specific VLAN number for which DHCP client settings are shown.
- 1 **Host Name**—Indicates the system name.
- 1 **Remove**—Removes the DHCP client instance on the selected interface from the **DHCP IP Interfaces Table**.
 - o **Checked**—Removes the interface from the **DHCP IP Interfaces Table**.
 - o **Unchecked**—Maintains the interface in the **DHCP IP Interfaces Table**.

Adding a DHCP IP Interface:

1. Open the **DHCP IP Interface** page.
2. Click **Add**. The **Add DHCP IP Interfaces** page opens.

Add DHCP IP Interfaces

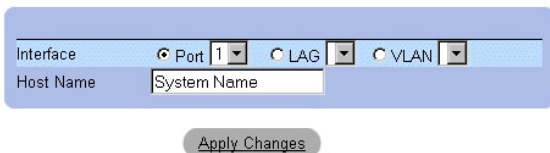

Add DHCP IP Interfaces

3. Select the **Interface** and define the **Host Name**.
4. Click **Apply Changes**. The new DHCP IP Interface is added, and the device is updated.

Modifying a DHCP IP Interface:

1. Open the **DHCP IP Interface** page.
2. Modify the **Interface** field.
3. Click **Apply Changes**. The entry is modified, and the device is updated.

Displaying the DHCP IP Interfaces Table:

1. Open the **DHCP IP Interface** page.
2. Click **Show All**. The **DHCP IP Interfaces Table Page** opens.

DHCP IP Interfaces Table

Interface	Host Name	Remove
1		<input type="checkbox"/>

[Apply Changes](#)

DHCP IP Interfaces Table Page

Deleting a DHCP IP Interface:

1. Open the **DHCP IP Interface** page.
2. Click **Show All**. The **DHCP IP Interfaces Table** opens.
3. Select a DHCP client entry.
4. Check the **Remove** check box to remove DHCP client entries.
5. Click **Apply Changes**. The **DHCP IP Interfaces Table** entries are deleted, and the device is updated.

Defining DHCP Clients Using CLI Commands

The following table summarizes the equivalent CLI commands for viewing fields displayed in the **DHCP IP Interface** page.

CLI Command	Description
<code>ip address-dhcp [hostname <i>host-name</i>]</code>	Acquires an IP address on an ethernet interface from DHCP.

The following is an example of the CLI commands:

```
Console (config)# interface ethernet 1/e8
```

```
Console (config-if)# ip address-dhcp hostname marketing
```

Configuring ARP

The **Address Resolution Protocol (ARP)** is a TCP/IP protocol that converts IP addresses into physical addresses. The static entries can be defined in the ARP Table. When static entries are defined, a permanent entry is entered and is used to translate IP address to MAC addresses. To open the **ARP Settings** page:

1. Click **System > IP Addressing > ARP** in the Tree View. The **ARP Settings** page opens.

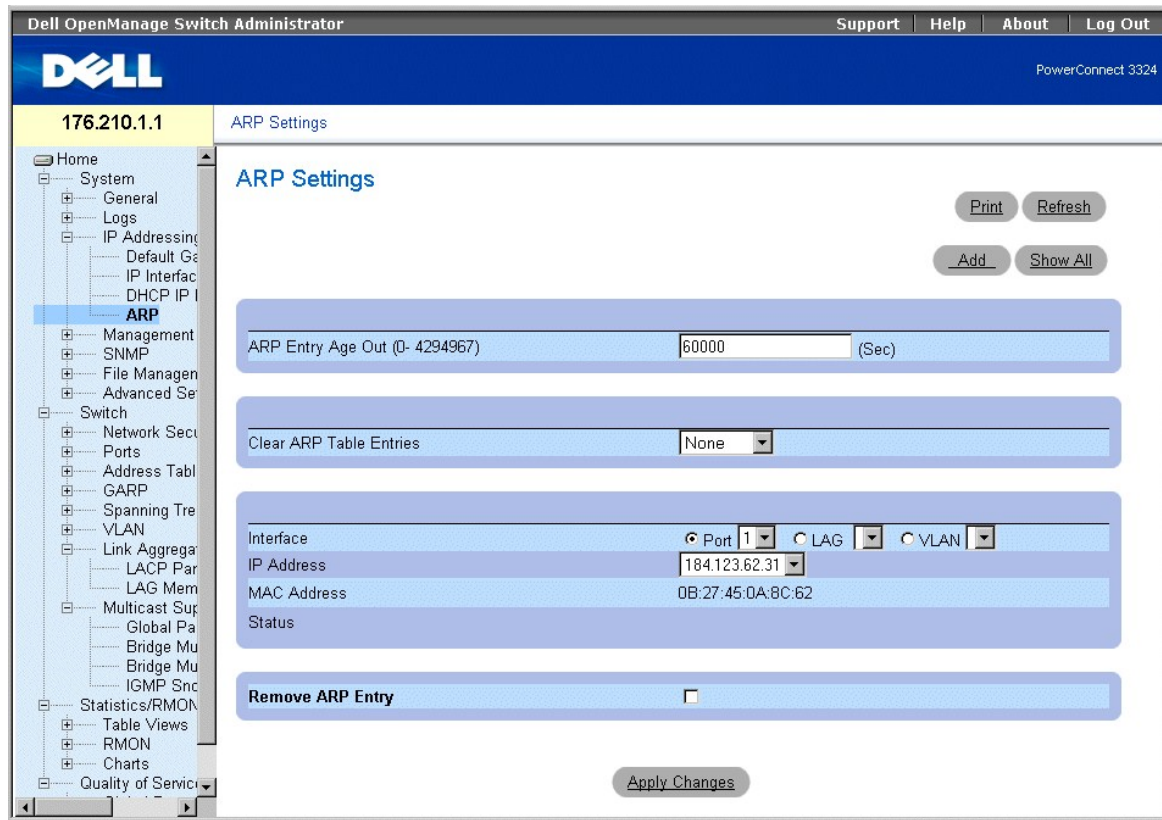

ARP Settings Page

The **ARP Settings** page contains the following fields:

- 1 **ARP Entry Age Out (0-4000000)**—Indicates the amount of time (seconds) that passes before an ARP entry is aged out. After this period, the entry is deleted from the table. The default value is 60,000 seconds.
- 1 **Clear ARP Table Entries**—Indicates the type of ARP entries that are cleared. The possible field values are:
 - o **None**—Indicates that ARP entries are not cleared.
 - o **All**—Indicates that all ARP entries are cleared.
 - o **Static**—Indicates that only static ARP entries are cleared.
 - o **Dynamic**—Indicates that only dynamic ARP entries are cleared.
- 1 **Interface**—Select the interface type and the specific interface number. The possible field values:
 - o **Port**—Contains the port list for which ARP can be defined.
 - o **LAG**—Contains the LAG list for which ARP can be defined.
 - o **VLAN**—Contains the VLAN list for which ARP can be defined.
- 1 **IP Address**—Select an IP address that is associated with the specified interface.
- 1 **MAC Address**—Specifies the associated MAC address.
- 1 **Status**—Specifies the status of the **ARP Table** entry. The possible field values are:
 - o **Other**—Indicates that the ARP entry is neither dynamically learned nor is it a static entry.
 - o **Invalid**—Indicates that the ARP entry is invalid.
 - o **Dynamic**—Indicates that the ARP entry was learned dynamically.
 - o **Static**—Indicates that the ARP entry is a static entry.
- 1 **Remove ARP Entry**—Removes an ARP entry from the **ARP Table**.
 - o **Checked**—Removes a specific ARP entry.
 - o **Unchecked**—Maintains ARP entries.

Adding a static ARP Table entry:

1. Open the **ARP Settings** page.
2. Click **Add**. The **Add ARP Entry** page opens.

Add ARP Entry

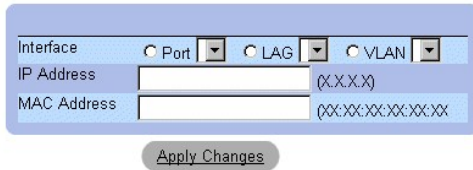

Add ARP Entry Page

3. Select an **Interface** and define its **IP Address** and **MAC address** fields.
4. Click **Apply Changes**. The **ARP Table** entry is added, and the device is updated.

Displaying the ARP Table:

1. Open the **ARP Setting** page.
2. Click **Show All**. The **ARP Table** page opens.

ARP Table

Refresh

Interface	IP Address	MAC Address	Status	Remove
1			Dynamic	<input type="checkbox"/>

ARP Table Page

Deleting ARP Table entry:

1. Open the **ARP Setting** page.
2. Click **Show All**. The **ARP Table** page opens.
3. Select a table entry.
4. Check the **Remove** check box
5. Click **Apply Changes**. The **ARP Table** entry is deleted, and the device is updated.

Configuring ARP Using the CLI Commands

The following table summarizes the equivalent CLI commands for viewing fields displayed in the **ARP Settings** page.

CLI Command	Description
<code>arp ip_addr hw_addr {ethernet interface-number vlan vlan-id port-channel number}</code>	Adds a permanent entry in the ARP cache.
<code>arp timeout seconds</code>	Configures how long an entry remains in the ARP cache.
<code>show arp</code>	Displays entries in the ARP Table.
<code>no arp</code>	Removes an ARP entry from the ARP Table.

The following is an example of the CLI commands:

```
console(config)# arp 146.1.0.131 00-00-55-66-77-00 ethernet 1/e1
```

```
Console (config)# exit
```

```
Console# arp timeout 12000
```

```
Console# show arp
```

```
Interface IP address HW address Status
```

```
-----
```

```
1/e1 10.7.1.102 00:10:B5:04:DB:4B Dynamic
```

```
2/e2 10.7.1.135 00:50:22:00:2A:A4 Static
```

Managing Device Security

The **Management Security** page provides access to security pages that allow network administrators to set security parameters for ports, device management methods, user, and server security. To open the **Management Security** page:

1. Click **System > Management Security** in the Tree View. The **Management Security** page opens.

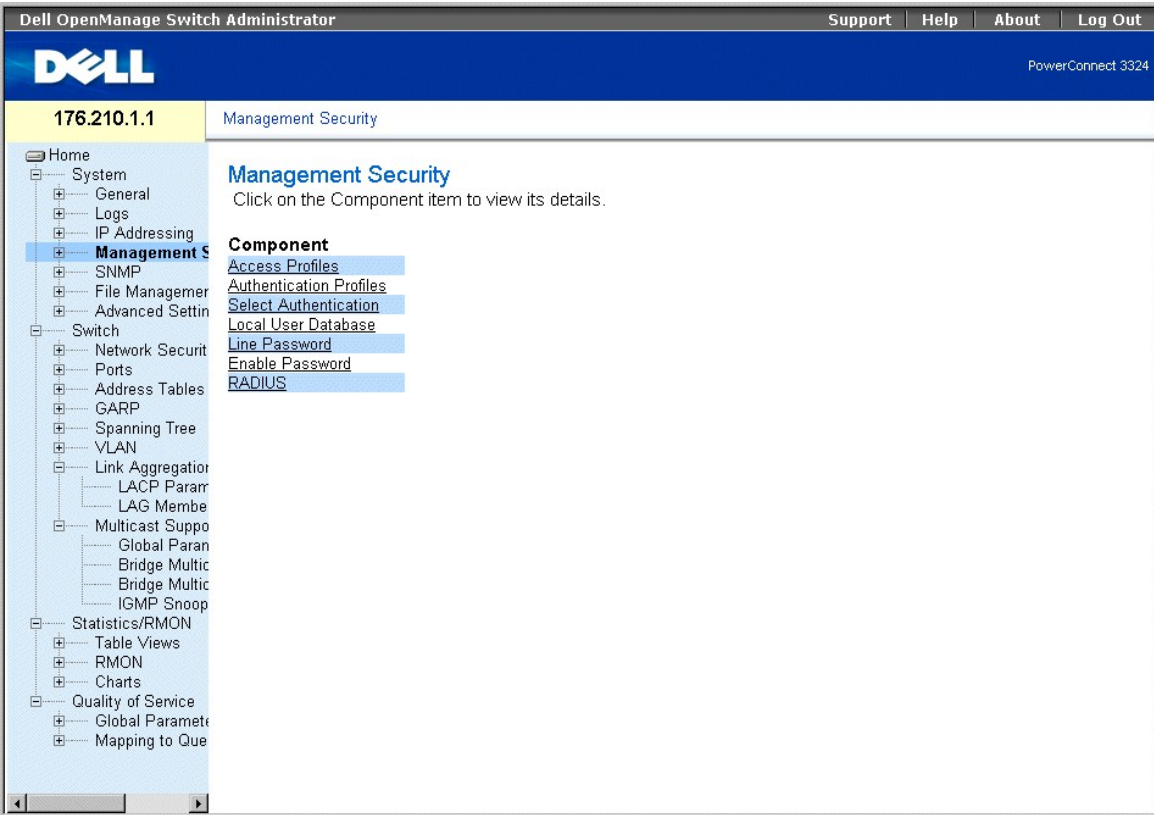

Management Security Page

This section includes the following topics:

- 1 [Defining Access Profiles](#)
- 1 [Defining Authentication Profiles](#)
- 1 [Assigning Authentication Profiles](#)
- 1 [Defining the Local User Databases](#)
- 1 [Defining Line Passwords](#)
- 1 [Defining Enable Password](#)
- 1 [Configuring RADIUS Global Parameters](#)

Defining Access Profiles

The **Access Profiles** page allows network managers to define profiles and rules for accessing the device. Management method access can be limited to a specific user group by Ingress Ports, Source IP address, and/or Subnet Masks. Management Access methods can be separately defined for:

- 1 Web Access (HTTP)
- 1 Secure Web Access (HTTPS)
- 1 Telnet
- 1 SNMP
- 1 All of the above

Users accessing one management service may differ from users managing a separate management service. Management Access Lists are comprised of rules that determine how the device is managed and by whom. To open the **Access Profiles** page:

- 1 Click **System** > **Management Security** > **Access Profiles** in the Tree View. The **Access Profiles** page opens.

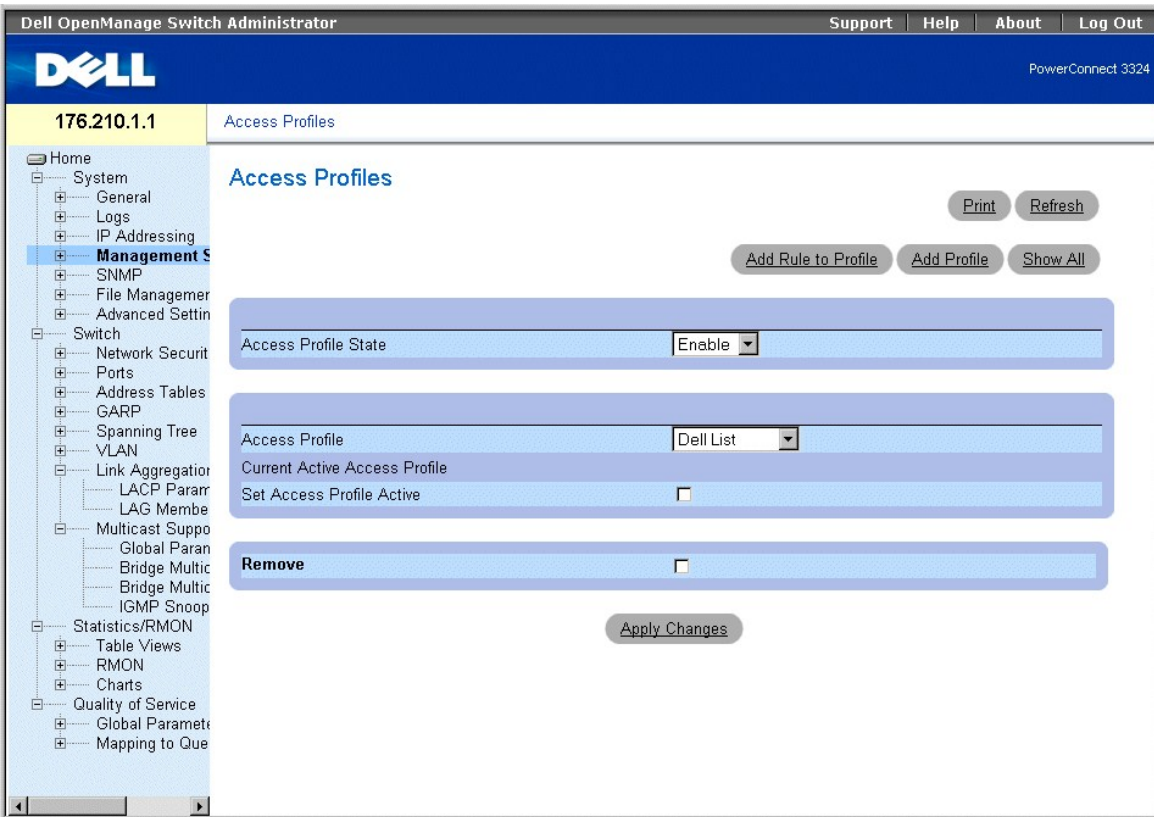

Access Profiles Page

The **Access Profiles** page contains the following fields:

1. **Access Profile State**—Enables the Access Profile on the device. The possible field values are:
 - o **Enable**—Enables Access Profile Security Management on the device.
 - o **Disable**—Disables the Access Profile Security Management on the device. If Access Profile Security Management is disabled, the device is accessible to all stations.
1. **Access Profiles**—Contains a list of user-defined **Access Profile Lists**. The **Access Profile** list contains the following default value:
 - o **Console Only**—Enables access only via the console. Selecting Console only disconnects HTTP and Telnet sessions. This is the default value, and cannot be removed.
1. **Current Active Access Profile** —Displays the Access Profile that is currently active.
1. **Set Access Profile Active**—Activates the selected Access Profile.
1. **Remove**—Removes the selected Access Profile from the **Access Profile Names**.
 - o **Checked**—Removes an Access Profile.
 - o **Unchecked**—Maintains an Access Profile.

 **NOTE:** Active profiles cannot be removed.

Activating a Profile:

1. Open the **Access Profiles** page.
2. Select an Access Profile in the **Access Profile** field.
3. Check the **Set Access Profile Active** check box.
4. Click **Apply Changes**. The Access Profile is activated.

Adding an Access Profile:

Rules act as filters for determining rule priority, the device management method, interface type, source IP address and network mask, and the device management access action. Users can be blocked or permitted management access. Rule priority sets the order of rule application in a profile.

To define rules for an access profile:

1. Open the **Access Profiles** page.
2. Click **Add Profile**. The **Add An Access Profile** page opens.

Add an Access Profile

Refresh

Access Profile Name

Rule Priority (1-65535)

Management Method: All

Interface Port LAG VLAN

Source IP Address: (X.X.X.X) Network Mask (X.X.X.X) Prefix Length (XX)

Action: Permit

Apply Changes

Add An Access Profile Page

The **Add An Access Profile** page contains the following fields:

1. **Access Profiles Name**—Specifies the Access Profile for which rules are defined.
1. **Rule Priority (1-65535)**—Indicates the rule priority (for an optional first rule to include in the new profile).
1. **Management Method**—Specifies the management method for which the Access Profile is defined. The possible field values:
 - o **All**—Indicates all management methods are assigned to the Access Profile.
 - o **Telnet**—Indicates all Telnet sessions are assigned to the Access Profile.
 - o **Secure Telnet**—Indicates Secure Telnet sessions are assigned to the Access Profile.
 - o **HTTP**—Indicates HTTP sessions are assigned to the Access Profile.
 - o **Secure HTTP**—Indicates Secure HTTP sessions are assigned to the Access Profile.
 - o **SNMP**—Indicates SNMP sessions are assigned to the Access Profile.
1. **Interface**—Specifies the interface to which the rule applies. The possible field values are:
 - o **Port**—Indicates the interface is a port, and the specific port for which the Access Profile is defined.
 - o **LAG**—Indicates the interface is a LAG, and the specific LAG for which the Access Profile is defined.
 - o **VLAN**—Indicates the interface is a VLAN, and the specific VLAN for which the Access Profile is defined.
1. **Source IP Address**—Indicates the interface Source IP Address to which the packet is matched.
1. **Network Mask**—Indicates the interface network mask to which the packet is matched.
1. **Prefix Length**—Indicates the prefix length to which the packet is matched.
1. **Action**—Defines the Management Security Rule action. The possible field values are:
 - o **Permit**—Permits management access to the defined interface.
 - o **Deny**—Denies management access to the defined interface.
3. Define the **Access Profile Name** field.
4. Define the **Rule Priority, Management Method, Interface, Source IP, Network Mask, Prefix Length, and Action** fields.

5. Click **Apply Changes**. The new Access Profile is added, and the device is updated.

Adding Rules to Access Profile:

 **NOTE:** The first rule must be defined to begin matching traffic to access profiles.

1. Open the **Access Profiles** page.
2. Click **Add Rule to Profile**. The **Add An Access Profile Rule** page opens.

Add an Access Profile Rule

[Refresh](#)

Priority (1-65535)	<input type="text"/>
Management Method	<input type="text" value="All"/>
<input type="checkbox"/> Interface	<input type="radio"/> Port <input type="radio"/> LAG <input type="radio"/> VLAN
<input type="checkbox"/> Source IP Address	<input type="text" value="(X.X.X.X)"/> <input type="radio"/> Network Mask <input type="text" value="0.0.0.0"/> (X.X.X.X) <input type="radio"/> Prefix Length <input type="text" value="(XX)"/>
Action	<input type="text" value="Permit"/>

[Apply Changes](#)

Add An Access Profile Rule Page

The **Add An Access Profile Rule** page contains the following fields:

- 1 **Access Profile Name**—Indicates the name of the Access Profile.
- 1 **Rule Priority (1-65535)**—Indicates the rule priority.
- 1 **Management Method**—Specifies the management method for which the access profile is defined. The possible field values:
 - o **All**—Indicates all management methods are assigned to the Access Profile. Users with this Access Profile can access the device using all management methods.
 - o **Telnet**—Indicates all Telnet sessions are assigned to the Access Profile. Users with this Access Profile access the device using the Telnet management method.
 - o **Secure Telnet**—Indicates Secure Telnet sessions are assigned to the Access Profile. Users with this Access Profile access the device using the Secure Telnet management method.
 - o **HTTP**—Indicates HTTP sessions are assigned to the Access Profile. Users with this Access Profile access the device using the HTTP management method.
 - o **Secure HTTP**—Indicates Secure HTTP sessions are assigned to the Access Profile. Users with this Access Profile access the device using the Secure HTTP management method.
 - o **SNMP**—Indicates SNMP sessions are assigned to the Access Profile. Users with this Access Profile access the device using the SNMP management method.
- 1 **Interface**—Specifies the interface to which the rule applies. The possible field values are:
 - o **Port**—Indicates the interface is a port, and the specific port for which the Access Profile is defined.
 - o **LAG**—Indicates the interface is a LAG, and the specific LAG for which the Access Profile is defined.
 - o **VLAN**—Indicates the interface is a VLAN, and the specific VLAN for which the Access Profile is defined.
- 1 **Source IP Address**—Indicates the interface source IP address to which the packet is matched.
- 1 **Network Mask**—Indicates the interface network mask to which the packet is matched.
- 1 **Prefix Length**—Indicates the prefix length to which the packet is matched.
- 1 **Action**—Defines the Management Security Rule action. The possible field values are:
 - o **Permit**—Permits management access to the defined interface.

- o **Deny**—Denies management access to the defined interface.
3. Define the **Access Profile Name** field.
 4. Define the **Rule Priority**, **Management Method**, **Interface**, **Source IP**, **Network Mask**, **Prefix Length**, and **Action** fields.
 5. Click **Apply Changes**. The rule is added, and the device is updated.

Viewing the Profile Rules Table:

 **NOTE:** The order in which rules appear in the **Profile Rules Table** is important. Packets are matched to the first rule which meets the rule criteria.

1. Open the **Access Profiles** page.
2. Click **Show All**.The **Profile Rules Table** page opens.

Profile Rules Table

Attribute	Value
Access Profile Name	

Interface	Rule Priority	Managem Method	Source IP Address	Prefix Length	Action	Remove
1		All			Permit	<input type="checkbox"/>

[Apply Changes](#)

Profile Rules Table Page

3. Click **Apply Changes**.

Removing a Rule:

 **NOTE:** When a rule is deleted, the profile name is also deleted.

1. Open the **Access Profiles** page.
2. Click **Show All**.The **Profile Rules Table** opens.
3. Select a rule in the **Profile Rules Table** page.
4. Check the **Remove** check box.
5. Click **Apply Changes**. The rule is deleted, and the device is updated.

Defining Access Profiles Using CLI Commands

The following table summarizes the equivalent CLI commands for viewing fields displayed in the **Access Profiles** page.

CLI Command	Description
<code>management access-list name</code>	Defines an access-list for management, and enters the access-list context for configuration.
<code>permit [ethernet interface-number vlan vlan-id port-channel number] [service service]</code>	Sets port permitting conditions for the management access list.
<code>permit ip-source ip-address [mask mask prefix-length] [ethernet interface-number vlan vlan-id port-channel number] [service service]</code>	Sets port permitting conditions for the management access list, and the selected management method.
<code>deny [ethernet interface-number vlan vlan-id port-channel number] [service service]</code>	Sets port denying conditions for the management access list, and the selected management method.
<code>deny ip-source ip-address [mask mask prefix-length] [ethernet interface-number vlan vlan-id port-channel number] [service service]</code>	Sets port denying conditions for the management access list, and the selected management method.
<code>management access-class { console-only name }</code>	Defines which access-list is used as the active management connections.
<code>show management access-list [name]</code>	Displays the active management access-lists.
<code>show management access-class</code>	Displays information about management access-class.

The following is an example of the CLI commands:

```
Console (config)# management access-list mlist

Console (config-macl)# permit ethernet 1/e1

Console (config-macl)# permit ethernet 2/e9

Console (config-macl)# deny ethernet 1/e2

Console (config-macl)# deny ethernet 2/e10

Console (config-macl)# exit

Console (config)# management access-class mlist

Console (config)# exit

Console# show management access-list

mlist

-----

permit ethernet 1/e1

permit ethernet 2/e9

! (Note: all other access implicitly denied)

Console> show management access-class

Management access-class is enabled, using access list mlist
```

Defining Authentication Profiles

The **Authentication Profiles** page allows network managers to select the user authentication method on the device. User authentication occurs:

- 1 Locally
- 1 Via an external server

User authentication can also be set to **None**.

User authentication occurs in the order the methods are selected. For example, if both the **Local** and **RADIUS** options are selected, the user is authenticated first locally. If the local user database is empty, the user is then authenticated via the RADIUS server.

If an error occurs during the authentication, the next selected method is used. To open the **Authentication Profiles** page:

- 1 Click **System > Management Security > Authentication Profiles** in the Tree View. The **Authentication Profiles** page opens.

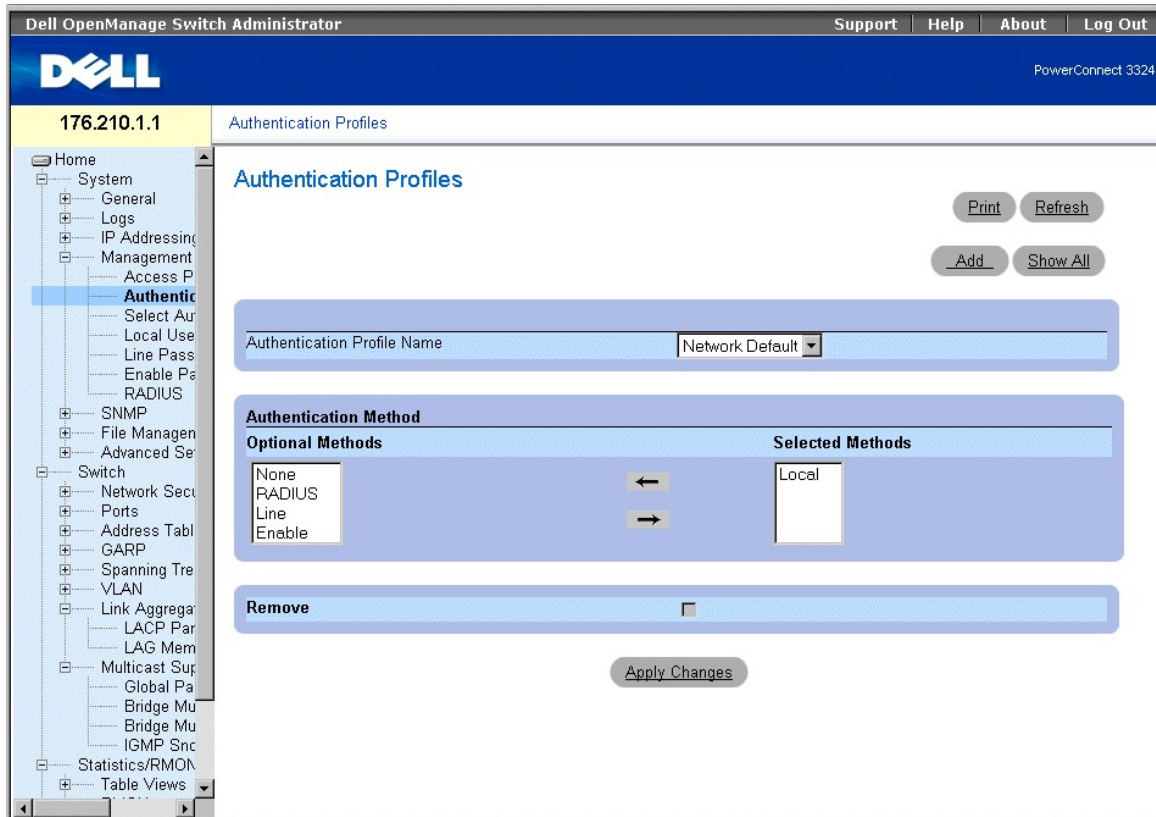

Authentication Profiles Page

The **Authentication Profiles** page contains the following options lists:

- 1 **Authentication Profile Name**—Displays the user-defined authentication method lists and includes the following values:
 - o **Network Default**
 - o **Console Default**
- 1 **Optional Methods**—Lists the user authentication methods. The possible options are:
 - o **Local**—Indicates that authentication occurs locally. The device checks the user name and password for authentication.
 - o **None**—Indicates that no user authentication occurs.
 - o **RADIUS**—Indicates that user authentication occurs in the RADIUS server.
 - o **Line**—Indicates that the line password is used for authentication.
 - o **Enable**—Indicates the enable password is used for authentication.
- 1 **Selected Methods**—Indicates the selected authentication methods and their order.
- 1 **Remove**—Removes the selected Authentication Profile from the **Authentication Profile Name** list.
 - o **Checked**—Removes an Authentication Profile.
 - o **Unchecked**—Maintains an Authentication Profile.

Selecting an Authentication Profile:

1. Open the **Authentication Profiles** page.
2. Select a profile in the **Authentication Profile Name** field.
3. Select the authentication method using the arrow icons.
4. Click **Apply Changes**. The user authentication profile is updated to the device.

Adding an Authentication Profile:

1. Open the **Authentication Profile** page.
2. Click **Add**. The **Add Authentication Method Profile Name** page opens.

Add Authentication Profile

Refresh

Profile Name

Apply Changes

Add Authentication Profile Page

Displaying the Show All Authentication Profiles Page:

1. Open the **Authentication Profiles** page.
2. Click **Show All**. The **Open the Authentication Profile** page opens:

Show All Authentication Profiles

	Profile Name	Methods	Remove
1	Network Default	Local	<input type="checkbox"/>
2	Console Default	None	<input type="checkbox"/>
3	Dell	Radius; Local; None	<input type="checkbox"/>

Apply Changes

Authentication Profile Page

Deleting an Authentication Profile:

1. Open the **Authentication Profiles** page.
2. Click **Show All**. The **Open the Authentication Profile** page opens.
3. Select an authentication profile.
4. Check the **Remove** check box.
5. Click **Apply Changes**. The authenticating profile is deleted.

Configuring an Authentication Profile Using CLI Commands

The following table summarizes the equivalent CLI commands for viewing fields displayed in the **Authentication Profiles** page.

CLI Command	Description
<code>aaa authentication login { default list-name } method1 [method2.]</code>	Configures login authentication.

<code>no aaa authentication login { default list-name</code>	Removes a login authentication profile.
--	---

The following is an example of the CLI commands:

```
Console (config)# aaa authentication login default radius local enable none
```

```
Console (config)# no aaa authentication login default
```

Assigning Authentication Profiles

After Authentication Profiles are defined, the Authentication Profiles can be applied to Management Access methods. For example, console users can be authenticated by Authentication Method Lists 1, while Telnet users are authenticated by Authentication Method List 2. To open the **Management Authentication** page:

- 1 Click **System > Management Security > Select Authentication** in the Tree View. The **Select Authentication** page opens.

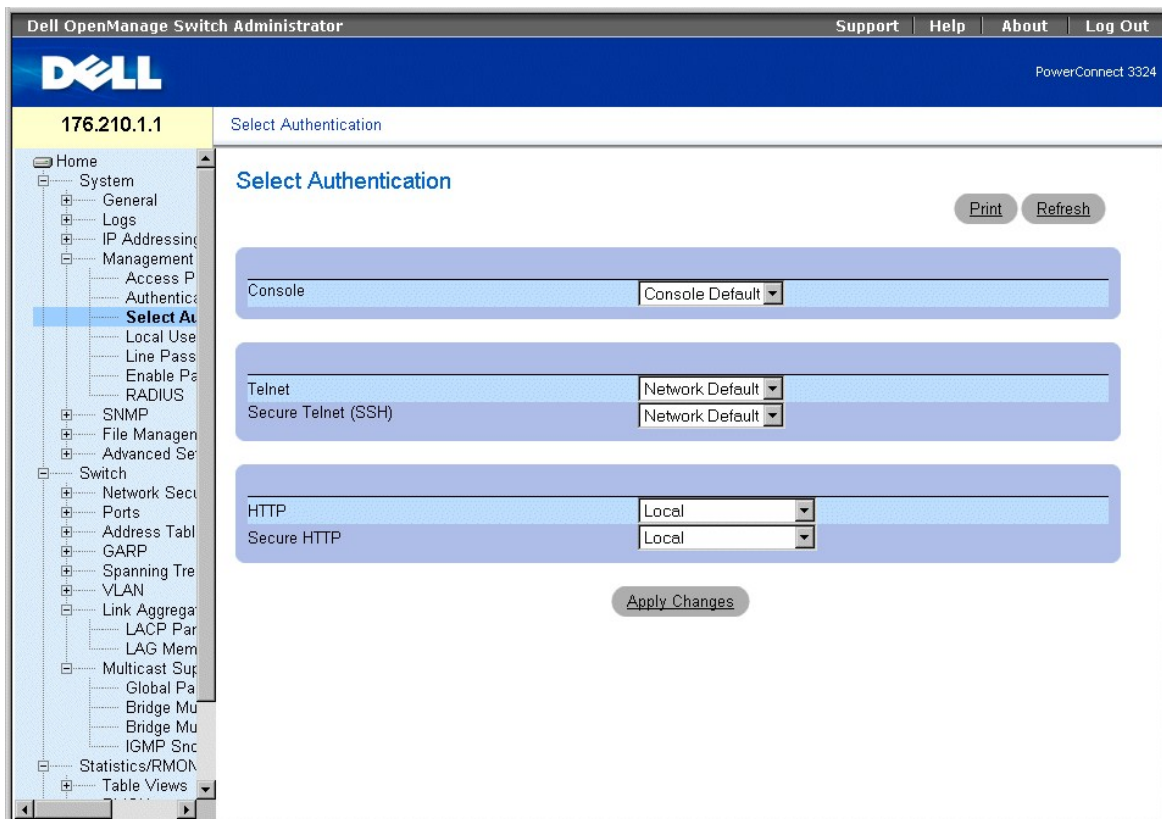

Select Authentication Page

The **Select Authentication** page contains the following fields:

- 1 **Console**—Displays the Authentication Profiles used to authenticate console users. Authentication Profiles are assigned in the ["Assigning Authentication Profiles"](#). There are two predefined field values to which other Authentication Profiles can be added. However the predefined values cannot be deleted. The predefined field values are:
 - o **Network Default**
 - o **Console Default**
- 1 **Telnet**—Displays the Authentication Profiles used to authenticate Telnet users. Authentication Profiles are assigned in [Assigning Authentication Profiles](#). There are two predefined field values to which other Authentication Profiles can be added. However the predefined values cannot be deleted. The

predefined field values are:

- o **Network Default**
 - o **Console Default**
- 1 **Secure Telnet (SSH)**—Displays the Authentication Profiles used to authenticate SSH users. Secure Shell (SSH) provides secure remote connections to a device. The SSH enables SSH clients to establish a secure, encrypted connection with a device. Authentication Methods Lists are assigned in the [Assigning Authentication Profiles](#).
 - 1 **HTTP**—Displays the authentication methods used for HTTP access. The possible field values are:
 - o **None**—Indicates that no authentication profile is used for HTTP access.
 - o **Local**—Indicates that HTTP authentication occurs locally.
 - o **Radius**—Indicates that HTTP authentication occurs at the RADIUS server, and HTTP access is permitted.
 - o **Local, None**—Indicates that HTTP authentication first takes place locally. If no authentication method is used, the local user database is empty and HTTP access is permitted.
 - o **Radius, None**—Indicates that HTTP authentication first takes place at the RADIUS server. If no authentication method is used, the RADIUS server cannot be accessed.
 - o **Local, Radius**—Indicates that HTTP authentication first takes place locally. If the RADIUS server authenticates the user, the local user database is empty. If the RADIUS server cannot authenticate the management method, the HTTP session is blocked.
 - o **Radius, Local**—Indicates that HTTP authentication first takes place at the RADIUS server. If the RADIUS server cannot be accessed, the HTTP session is authenticated locally. If the HTTP session cannot be authenticated locally, the HTTP session is blocked.
 - o **Local, Radius, None**—Indicates that HTTP authentication first takes place locally. If the local database is empty, the RADIUS server authenticates the management method. If the RADIUS server cannot be accessed, the HTTP session is permitted.
 - o **Radius, Local, None**—Indicates that HTTP authentication first takes place at the RADIUS server. If the RADIUS server cannot be accessed, the HTTP session is authenticated locally. If the local database is empty, the HTTP session is permitted.
 - 1 **Secure HTTP**—Specifies the authentication profiles used for Secure HTTP access. The possible field values are:
 - o **None**—Indicates that no authentication profiles is used for Secure HTTP access.
 - o **Local**—Indicates that Secure HTTP authentication occurs locally.
 - o **Radius**—Indicates that Secure HTTP authentication occurs at the RADIUS server.
 - o **Local, None**—Indicates that Secure HTTP authentication first takes place locally. If the local database is empty, no authentication method is used, and secure HTTP access is permitted.
 - o **Radius, None**—Indicates that Secure HTTP authentication first takes place at the RADIUS server. If the RADIUS server cannot be accessed, no authentication method is used, and secure HTTP access is permitted.
 - o **Local, Radius**—Indicates that Secure HTTP authentication first takes place locally. If the local database is empty, the RADIUS server authenticates the user. If the RADIUS server cannot authenticate the management method, the Secure HTTP session is blocked.
 - o **Radius, Local**—Indicates that Secure HTTP authentication first takes place at the RADIUS server. If the RADIUS server cannot be accessed, the Secure HTTP session is authenticated locally. If the Secure HTTP session cannot be authenticated locally, the Secure HTTP session is blocked.
 - o **Local, Radius, None**—Indicates that Secure HTTP authentication first takes place locally. If the local database is empty, the RADIUS server authenticates the management method. If the RADIUS server cannot access the database, the Secure HTTP session is permitted.
 - o **Radius, Local, None**—Indicates that Secure HTTP authentication first takes place at the RADIUS server. If the RADIUS server cannot be accessed, the Secure HTTP session is authenticated locally. If the local database is empty, the Secure HTTP session is permitted.

Applying an Authentication List to Console Sessions:

1. Open the **Select Authentication** page.
2. Select an Authentication Profile in the **Console** field.
3. Click **Apply Changes**. Console sessions are assigned an Authentication List.

Applying an Authentication Profile to Telnet Sessions:

1. Open the **Select Authentication** page.
2. Select an Authentication Profile in the **Telnet** field.
3. Click **Apply Changes**. Telnet sessions are assigned an Authentication List.

Applying an Authentication Profile to Secure Telnet (SSH) Sessions:

1. Open the **Select Authentication** page.
2. Select an Authentication Profile in the **Secure Telnet (SSH)** field.
3. Click **Apply Changes**. Secure Telnet (SSH) sessions are assigned an Authentication Profile.

Assigning HTTP Sessions a Authentication Sequence:

1. Open the **Select Authentication** page.

2. Select an authentication sequence in the **HTTP** field.
3. Click **Apply Changes**. HTTP sessions are assigned an authentication sequence.

Assigning Secure HTTP Sessions a Authentication Sequence:

1. Open the **Select Authentication** page.
2. Select an authentication sequence in the **Secure HTTP** field.
3. Click **Apply Changes**. Secure HTTP sessions are assigned an authentication sequence.

Assigning Access Authentication Profiles or Sequences Using CLI Commands

The following table summarizes the equivalent CLI commands for viewing fields displayed in the **Select Authentication** page.

CLI Command	Description
<code>enable authentication [default list-name]</code>	Specifies the authentication method list when accessing a higher privilege level from a remote Telnet or console.
<code>login authentication [default list-name]</code>	Specifies the login authentication method list for a remote Telnet or console.
<code>ip http authentication method1 [method2.]</code>	Specifies authentication methods for http servers.
<code>ip https authentication method1 [method2.]</code>	Specifies authentication methods for https servers.
<code>show authentication methods</code>	Displays information about the authentication methods.

The following is an example of the CLI commands:

```

Console (config-line)# enable authentication default

Console (config-line)# login authentication default

Console (config-line)# exit

Console (config)# ip http authentication radius local

Console (config)# ip https authentication radius local

Console (config)# exit

Console# show authentication methods

Login Authentication Method Lists

-----

Default: Radius, Local, Line

Console_Login: Line, None

```

Enable Authentication Method Lists

Default: Radius, Enable

console> enable: Enable, None

Line Login Method List Enable Method List

Console Console_Login Console_Enable

Telnet Default Default

SSH Default Default

HTTP: Radius, local

HTTPS: Radius, local

Defining the Local User Databases

The **Local User Database** page allows network managers to define users, passwords and access levels. Password are limited to a maximum of 16 characters. To open the **Local User Database** page:

- 1 Click **System > Management Security > Local User Database** in the Tree View. The **Local User Database** page opens.

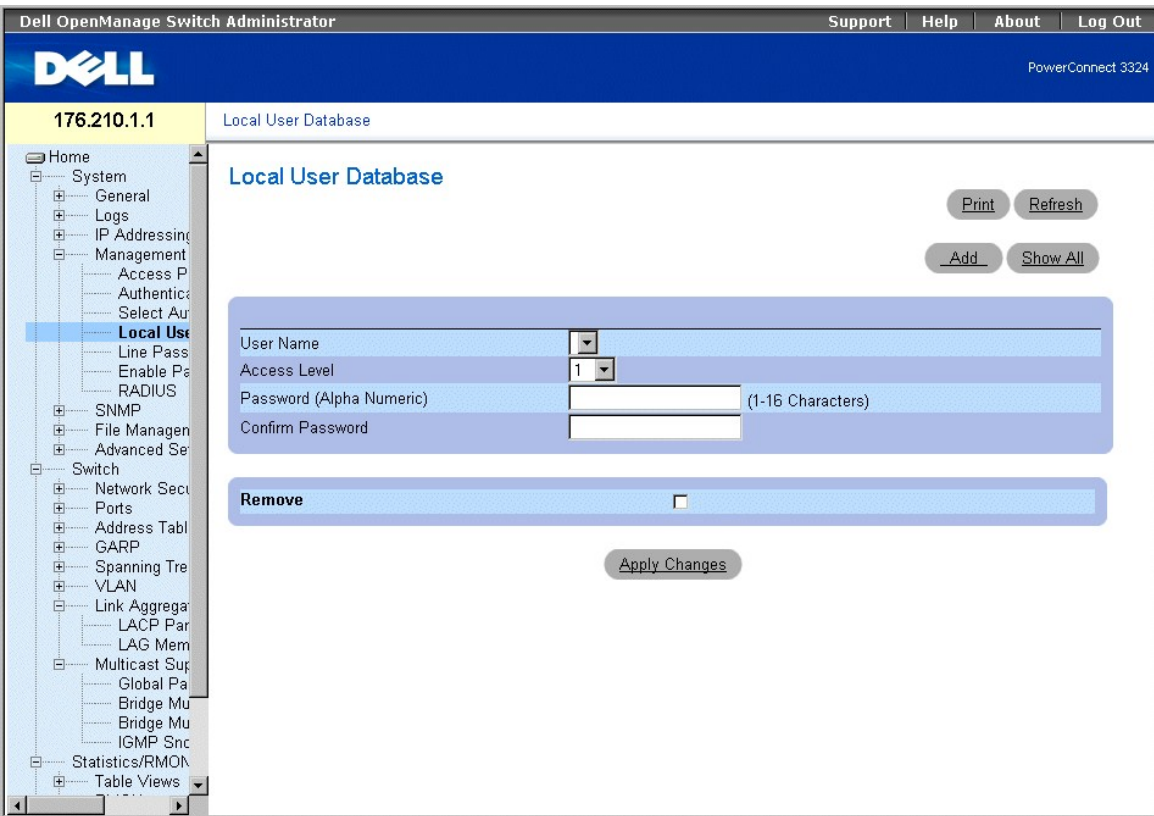

Local User Database Page

The **Local User Database** page contains the following fields:

- 1 **User Name**—Contains a list of users.
- 1 **Access Level**—Determines the user access level. The possible values are:
 - o **1-15**—Indicates the user access level. **1** indicates the lowest user access level.
- 1 **Password (Alpha Numeric)**—Specifies the user password. The password is displayed as *****.
- 1 **Confirm Password**—Confirms the user-defined password. The confirmed password is displayed as *****.
- 1 **Remove**—Removes users from the **User Name** list.
 - o **Checked**—Removes a specific user from the **Local User Database**.
 - o **Unchecked**—Maintains the user in the **Local User Database**.

Assigning access rights to a user:

1. Open the **Local User Database** page.
2. Select a user in the **User Name** field.
3. Define the **Access Level**, and **Password** fields.
4. Click **Apply Changes**. The user access rights and passwords are defined, and the device is updated.

Defining a New User:

1. Open the **Local User Database** page.
2. Click **Add**. The **Add User** page opens:

Refresh

Add User

User Name	<input type="text"/>
Access Level (0-15)	0 ▾
Password	<input type="password"/>
Confirm Password	<input type="password"/>

Apply Changes

Add User Page

3. Define a new user name in the **User Name**, **Access Level (1-15)**, **Password**, and **Confirm Password** fields.
4. Click **Apply Changes**. The new user is defined, and the device is updated.

Displaying the Local User Table:

1. Open the **Local User Database** page.
2. Click **Show All**. The **Local User Table** page opens.

Local User Table

	User Name	Access Level	Remove
1			<input type="checkbox"/>

Apply Changes

Local User Table Page

Deleting Users:

1. Open the **Local User Database** page.
2. Click **Show All**. The **Local User Table** page opens.
3. Select a **User Name**.
4. Check the **Remove** check box.
5. Click **Apply Changes**. The user is deleted, and the device is updated.

Assigning Users Using CLI Commands

The following table summarizes the equivalent CLI commands for viewing fields displayed in the **Local User Database** page.

CLI Command	Description
<code>username name [password password] [privilege level] [encrypted]</code>	Establishes a username-based authentication system.

The following is an example of the CLI commands:

```
Console (config)# username bob password lee privilege 15
```

Defining Line Passwords

The **Line Passwords** page allows network managers to define line passwords for management methods. Passwords are limit to maximum of 16 characters. To open the **Line Passwords** page:

1. Click **System > Management Security > Line Passwords** in the Tree View. The **Line Password** page opens.

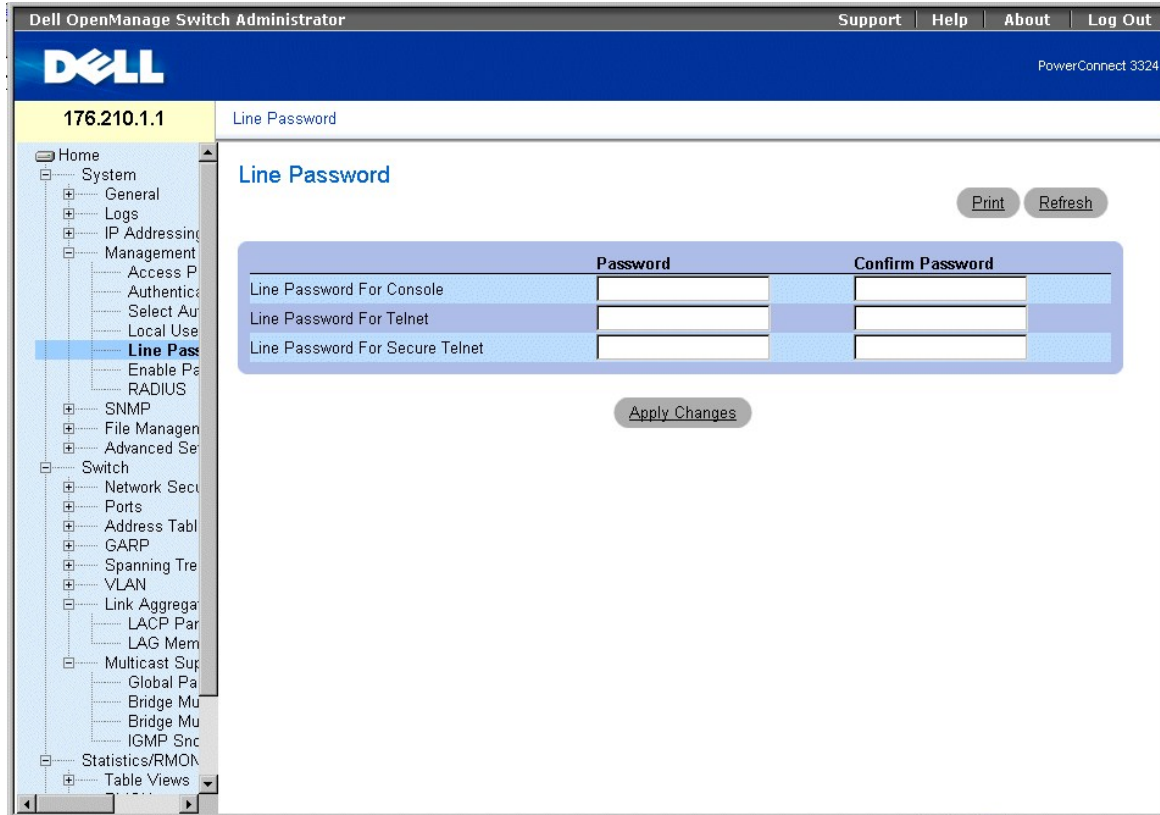

Line Password Page

The **Line Password** page contains the following fields:

1. **Line Password For Console**—Specifies the line password for accessing the device via a console session. The password is displayed as *****.
1. **Line Password For Telnet**—Specifies the line password for accessing the device via a Telnet session. The password is displayed as *****.
1. **Line Password For Secure Telnet**—Specifies the Line Password for accessing the device via a Secure Telnet session. The password is displayed as *****.

Defining line passwords for console sessions:

1. Open the **Line Password** page.
2. Define the **Line Password for Console** field.
3. Click **Apply Changes**. The line password for console sessions is defined, and the device is updated.

Defining line passwords for Telnet sessions:

1. Open the **Line Password** page.
2. Define the **Line Password for Telnet** field.
3. Click **Apply Changes**. The line password for the Telnet sessions is defined, and the device is updated.

Defining line passwords for secure Telnet sessions:

1. Open the **Line Password** page.
2. Define the **Line Password for Secure Telnet** field.
3. Click **Apply Changes**. The line password for Secure Telnet sessions is defined, and the device is updated.

Assigning Line Passwords Using CLI Commands

The following table summarizes the equivalent CLI commands for viewing fields displayed in the **Line Password** page.

CLI Command	Description
<code>password <i>password</i> [encrypted]</code>	Specifies a password on a line.

The following is an example of the CLI commands:

```
Console (config-line)# password dell
```

Defining Enable Password

The **Modify Enable Password** page sets a local password to control access to Normal, Privilege, and Global Configuration. To open the **Modify Enable Password** page.

1. Click **System > Management Security > Enable Passwords** in the Tree View. The **Modify Enable Password** page opens.

The screenshot shows the Dell OpenManage Switch Administrator interface. The top navigation bar includes 'Support', 'Help', 'About', and 'Log Out'. The main header displays the Dell logo and 'PowerConnect 3324'. The left sidebar shows a tree view with 'System > Management Security > Enable Passwords' selected. The main content area is titled 'Modify Enable Password' and contains a form with the following fields and buttons:

- Select Enable Access Level:** A dropdown menu currently set to '0'.
- Password:** A text input field.
- Confirm Password:** A text input field.
- Buttons:** 'Print', 'Refresh', and 'Apply Changes'.

Modify Enable Password Page

The **Modify Enable Password** page contains the following fields:

- 1 **Select Enable Access Level**—Specifies the access level associated with the Enable password.
- 1 **Password**—Indicates the Enable password. The password is displayed as *****.
- 1 **Confirm Password**—Confirms the new Enable password. The confirmed password is displayed as *****.

Defining a new Enable Password:

1. Open the **Modify Enable Password** page.
2. Define the **Select Enable Access Level**, **Password**, and **Confirm Password** fields.
3. Click **Apply Changes**. The new Enable password is defined, and the device is updated.

Assigning Enable Passwords Using CLI Commands

The following table summarizes the equivalent CLI commands for viewing fields displayed in the **Modify Enable Password** page.

CLI Command	Description
<code>enable password [level level] password [encrypted]</code>	Sets a local password to control access to user and privilege levels.
<code>show users accounts</code>	Displays information about the local user database.

The following is an example of the CLI commands:

```
Console (config)# enable password level 15 dell
```

```
Console# show users accounts
```

```
Username Privilege
```

```
-----
```

```
Bob 15
```

```
Robert 15
```

Configuring RADIUS Global Parameters

Remote Authorization Dial-In User Service (RADIUS) servers provide additional security for networks. RADIUS servers provide a centralized authentication method for:

- 1 Telnet Access
- 1 Web Access
- 1 Console to Switch Access

To open the **RADIUS Settings** page:

- 1 Click **System > Management Security > RADIUS** in the Tree View. The **RADIUS Settings** page opens.

The screenshot shows the Dell OpenManage Switch Administrator interface. The top navigation bar includes 'Support', 'Help', 'About', and 'Log Out'. The main header displays the Dell logo and 'PowerConnect 3324'. The left sidebar shows a navigation tree with 'RADIUS' selected. The main content area is titled 'RADIUS Settings' and contains two sections: 'RADIUS Settings' and 'Default Parameters'. Each section contains a table of configuration fields.

RADIUS Settings	
IP Address	[Dropdown]
Priority (1-65535)	[Input]
Authentication Port	1645
Number of Retries (1-10)	3
Timeout for Reply (1-30)	3 (Sec)
Dead Time (0-2000)	0 (Sec)
Key String (1-16 Characters)	[Input] (Alpha Numeric)
Source IP Address	0 (X.X.X.X)

Default Parameters	
Default Timeout for Reply (1-30)	3 (Sec)
Default Retries (1-10)	3
Default Dead time (0-2000)	0 (Sec)
Default Key String (1-16 Characters)	[Input]
Source IP Address	[Input] (X.X.X.X)

RADIUS Settings Page

The **RADIUS Settings** page contains the following fields:

- 1 **IP Address**—Indicates the list of Authentication Server IP addresses.
- 1 **Priority (1-65535)**—Indicates the server priority. The possible values are 1-65535, where 1 is the highest value. This is used to configure the order in which servers are queried.
- 1 **Authentication Port**—Identifies the authentication port. The authentication port is used to verify the RADIUS server authentication.
- 1 **Number of Retries (1-10)**—Specifies the number of transmitted requests sent to RADIUS server before a failure occurs. The possible field values are 1-10. Three is the default value.
- 1 **Timeout for Reply (1-30)**—Specifies the amount of the time in seconds the device waits for an answer from the RADIUS server before retrying the query or switching to the next server. The possible field values are 1-30. Three is the default value.
- 1 **Dead Time (0-2000)**—Specifies the amount of time (in sec) that a RADIUS server is bypassed for service requests. The range is 0-2000.
- 1 **Key String (1-16 Characters)**—Indicates the Key string used for authenticating and encrypting all RADIUS communications between the device and the RADIUS server. This key is encrypted.
- 1 **Source IP Address**—Indicates the IP Address to use for the device accessing the RADIUS server.

The following fields set the RADIUS default values:

- 1 **Default Timeout for Reply (1-30)**—Specifies the default amount of time (in seconds) the device waits for an answer from the RADIUS server before timing out.

NOTE: If **Host Specific Timeouts**, **Retransmit**, **Dead Time**, or **Deny** values are not specified, the Global values are applied to each host.

- 1 **Default Retries (1-10)**—Specifies the default number of transmitted requests sent to RADIUS server before a failure occurs.
- 1 **Default Dead time (0-2000)**—Specifies the default amount of time (in seconds) that a RADIUS server is bypassed for service requests. The range is 0-2000.
- 1 **Default Key String (1-16 Characters)**—Indicates the Default Key string used for authenticating and encrypting all RADIUS communications between the device and the RADIUS server. This key is encrypted.

1. **Source IP Address**—Indicates the default IP Address for the device accessing the RADIUS server.

Defining RADIUS Parameters:

1. Open the **RADIUS Settings** page.
2. Define the **Default Timeout for Reply**, **Default Retries**, **Default Dead Time**, and **Default Key Strings** fields.
3. Click **Apply Changes**. The RADIUS settings are updated to the device.

Adding a RADIUS Server:

1. Open the **RADIUS Settings** page.
2. Click **Add**. The **Add RADIUS Settings** page opens:

Add RADIUS Server

Refresh

IP Address	<input type="text"/>	(X.X.X.X)
Priority (0-65535)	<input type="text"/>	
Authentication Port	<input type="text" value="1645"/>	
Number of Retries (1-10)	<input type="text" value="3"/>	(Sec)
Timeout for Reply (1-30)	<input type="text" value="3"/>	(Sec)
Dead Time (0-2000)	<input type="text" value="0"/>	(Sec)
Key String (1-16 Characters)	<input type="text"/>	
Source IP Address	<input type="text"/>	

Apply Changes

Add RADIUS Server Page

3. Define the **IP Address**, **Priority**, **Authentication Port**, **Number of Retries**, **Timeout for Reply**, **Dead Time**, **Key String**, and **Source IP Address** fields.
4. Click **Apply Changes**. The new RADIUS server is added, and the device is updated.

Displaying the RADIUS Server List:

1. Open the **RADIUS Settings** page.
2. Click **Show All**. The **RADIUS Servers List** page opens.

IP Address	Authentication Port	Number of Retries	Timeout for Reply	Dead Time	Priority	Remove
1	<input type="text"/>	<input type="text"/>	<input type="text"/>	<input type="text"/>	<input type="text"/>	<input type="checkbox"/>

RADIUS Servers List Page

Modifying the RADIUS Server settings:

1. Open the **RADIUS Settings** page.
2. Click **Show All**. The **RADIUS Servers List** page opens.
3. Modify the **Priority**, **Number of Retries**, **Timeout for Reply**, or **Dead Time** fields.
4. Click **Apply Changes**. The RADIUS Server settings are modified, and the device is updated.

Deleting a RADIUS Server for the RADIUS Servers List:

1. Open the **RADIUS Settings** page.
2. Click **Show All**. The **RADIUS Servers List** page opens.
3. Select a RADIUS Server in the **RADIUS Servers List**.
4. Check the **Remove** check box. The RADIUS server is removed from the **RADIUS Servers List**.

Defining RADIUS Servers Using CLI Commands

The following table summarizes the equivalent CLI commands for viewing fields displayed in the **RADIUS Settings** page.

CLI Command	Description
<code>radius-server timeout <i>timeout</i></code>	Sets the default interval for which a device waits for a server host to reply.
<code>radius-server retransmit <i>retries</i></code>	Specifies the default number of times the software searches the list of RADIUS server hosts.
<code>radius-server deadtime <i>deadtime</i></code>	Configures unavailable default servers to be skipped.
<code>radius-server key <i>key-string</i></code>	Sets the default authentication and encryption key for all RADIUS communications between the device and the RADIUS environment.
<code>radius-server host <i>ip-address</i> [<i>auth-port auth-port-number</i>] [<i>timeout timeout</i>] [<i>retransmit retries</i>] [<i>deadtime deadtime</i>] [<i>key key-string</i>] [<i>source source</i>] [<i>priority priority</i>]</code>	Specifies a RADIUS server host and any non-default settings.
<code>show radius-servers</code>	Displays the RADIUS server settings.

The following is an example of the CLI commands:

```

Console (config)# radius-server timeout 5

Console (config)# radius-server retransmit 5

Console (config)# radius-server deadtime 10

Console (config)# radius-server key dell-server

Console (config)# radius-server host 196.210.100.1 auth-port 1645 timeout 20

Console# show radius-servers

Port

IP address Auth Acct TimeOut Retransmit deadtime Priority
-----
172.16.1.1 1645 1646 3 3 0 1

172.16.1.2 1645 1646 11 8 0 2

```

Defining SNMP Parameters

Simple Network Management Protocol (SNMP) provides a method for managing network devices. Devices supporting SNMP run a local software (agent).

The SNMP agents maintain a list of variables, which are used to manage the device. The variables are defined in the Management Information Base (MIB). The MIB presents the variables controlled by the agent. The SNMP protocol defines the MIB specification format as well as the format used to access the information over the network.

Access rights to the SNMP agents are controlled by access strings. To communicate with the device, the Embedded Web Server submits a valid community string for authentication. To open the SNMP page:

1. Click **System** > **SNMP** in the Tree View. The **SNMP** page opens.

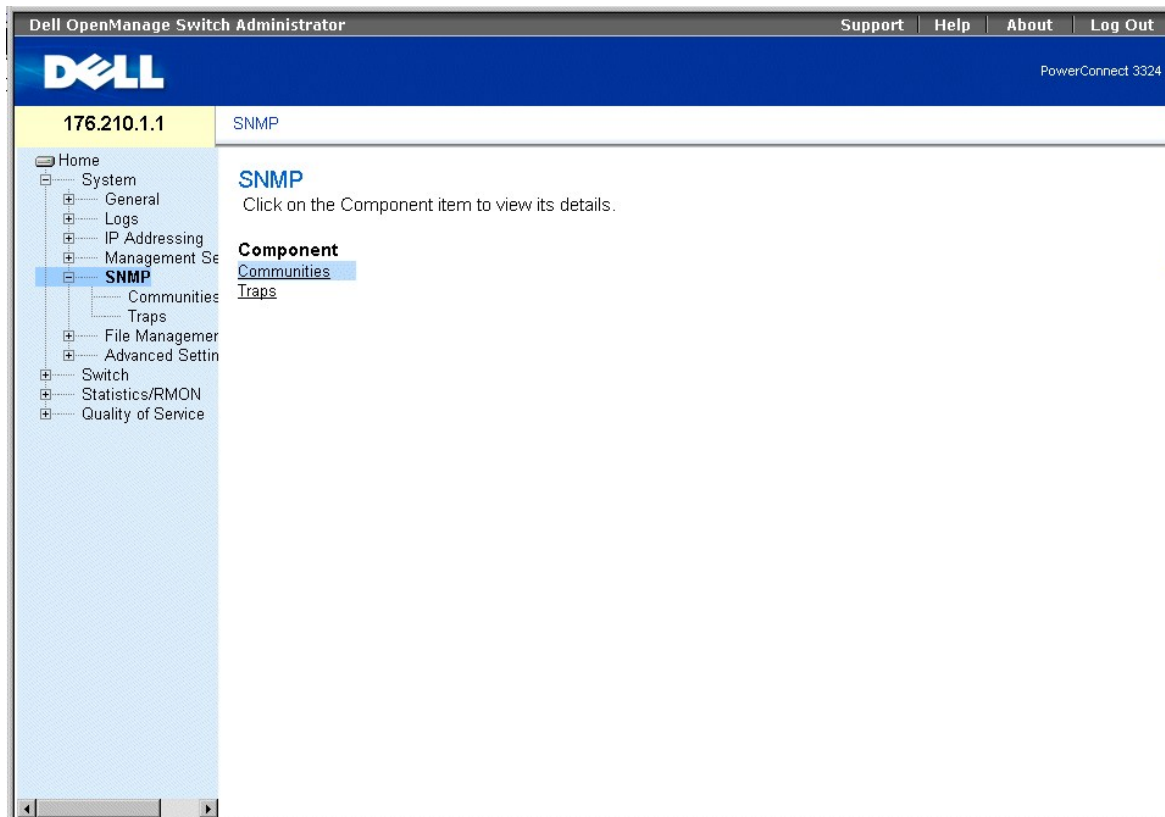

SNMP Page

This section contains information for managing the SNMP configuration, and includes the following topics:

1. [Defining Communities](#)
1. [Defining Traps](#)

Defining Communities

The system administrator manages access rights (read and write, read only, and so on.) by defining communities in the Community Table. When the community names are changed, access rights are also changed. To open the **SNMP Community** page:

1. Click **System** > **SNMP** > **Communities** in the Tree View. The **SNMP Community** page opens.

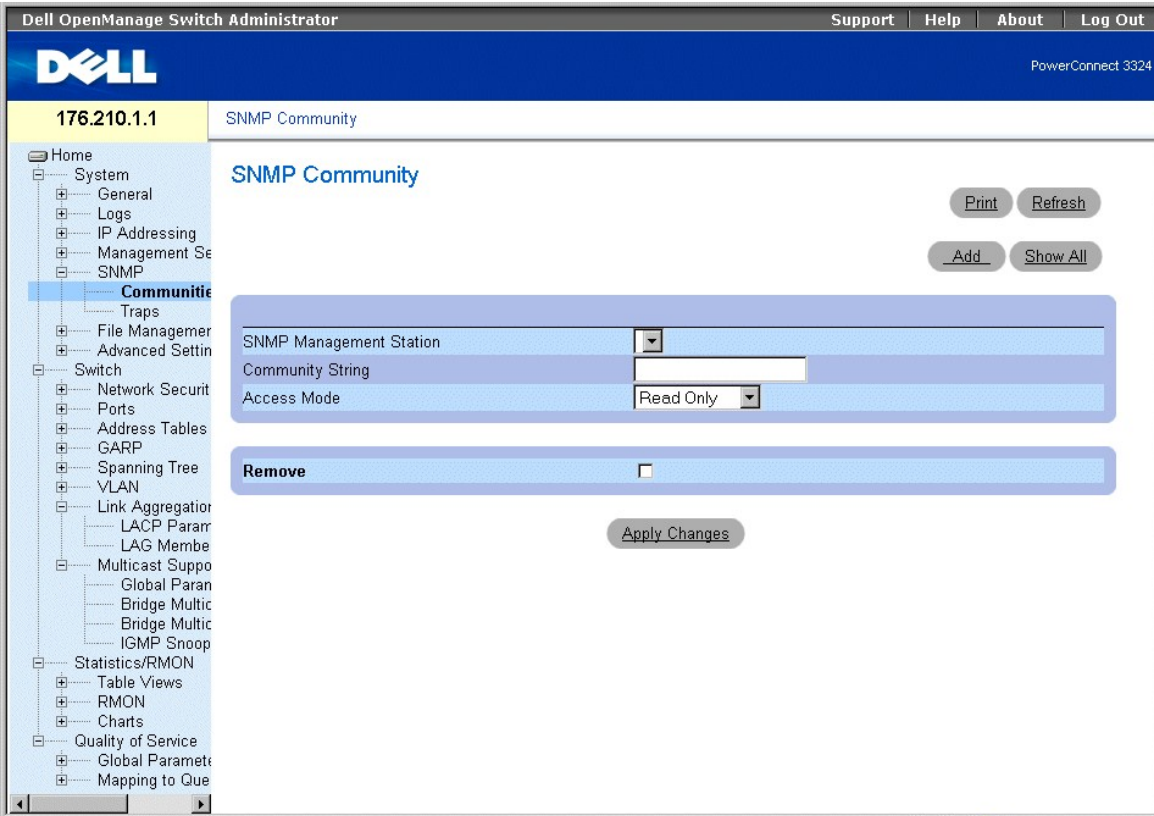

SNMP Community Page

The **SNMP Community** page contains the following fields:

- 1 **SNMP Management Station**—Indicates a list of management station IP addresses.
- 1 **Community String**—Functions as a password and used to authenticate the selected management station to the device.
- 1 **Access Mode**—Defines the access rights of the community. The possible field values are:
 - o **Read Only**—Indicates that the management access is restricted to read-only, and changes cannot be made to the community.
 - o **Read Write**—Indicates that the management access is read-write and changes can be made to the device configuration, but not to the community.
 - o **SNMP Admin**—Indicates that the user has access to all device configuration options, as well to modifying the community.
- 1 **Remove**—Removes a community. The possible field values are:
 - o **Checked**—Removes the community.
 - o **Unchecked**—Maintains the community.

Defining a new community:

1. Open the **SNMP Community** page.
2. Click **Add**. The **Add SNMP Community** page opens.

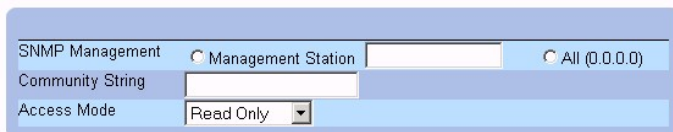

Add SNMP Community Page

In addition to the fields in the **SNMP Community** page, the **Add SNMP Community** page contains the following fields:

1. **SNMP Management**—Indicates if a SNMP community is defined for a specific management station or for all management stations. The possible field values are:
 - o **Management Station**—Indicates the management station IP address. A value of 0.0.0.0 specifies all management stations.
 - o **All**—Indicates that the SNMP community is defined for all management stations.
3. Define the **SNMP Management**, **Management Station**, **Community String**, and **Access Mode** fields.
4. Click **Apply Changes**. The new community is saved, and the device is updated.

Displaying all Communities

1. Open the **SNMP Community** page.
2. Click **Show All**. The **Community Table** page opens.

Community Table

[Refresh](#)

Management Station	Community String	Access Mode	Remove
1		Read Only	<input type="checkbox"/>

[Apply Changes](#)

Community Table Page

Deleting Communities:

1. Open the **SNMP Community** page.
2. Click **Show All**. The **Community Table** page opens.
3. Select a community from the **Community Table**.
4. Check the **Remove** check box.
5. Click **Apply Changes**. The community entry is deleted, and the device is updated.

Configuring Communities Using CLI Commands

The following table summarizes the equivalent CLI commands for viewing fields displayed in the **SNMP Community** page.

CLI Command	Description
<code>snmp-server community string [ro rw su] [ip-address]</code>	Sets up the community access string to permit access to SNMP protocol.
<code>show snmp</code>	Checks the status of SNMP communications.

The following is an example of the CLI commands:

```
Console (config)# snmp-server community public su 0.0.0.0
```

Defining Traps

From the **SNMP Trap Settings** page, the user can enable or disable the device to send SNMP traps or notifications. To open the **SNMP Trap Settings** page:

- 1 Click **System > SNMP > Traps** in the Tree View. The **SNMP Trap Settings** page opens.

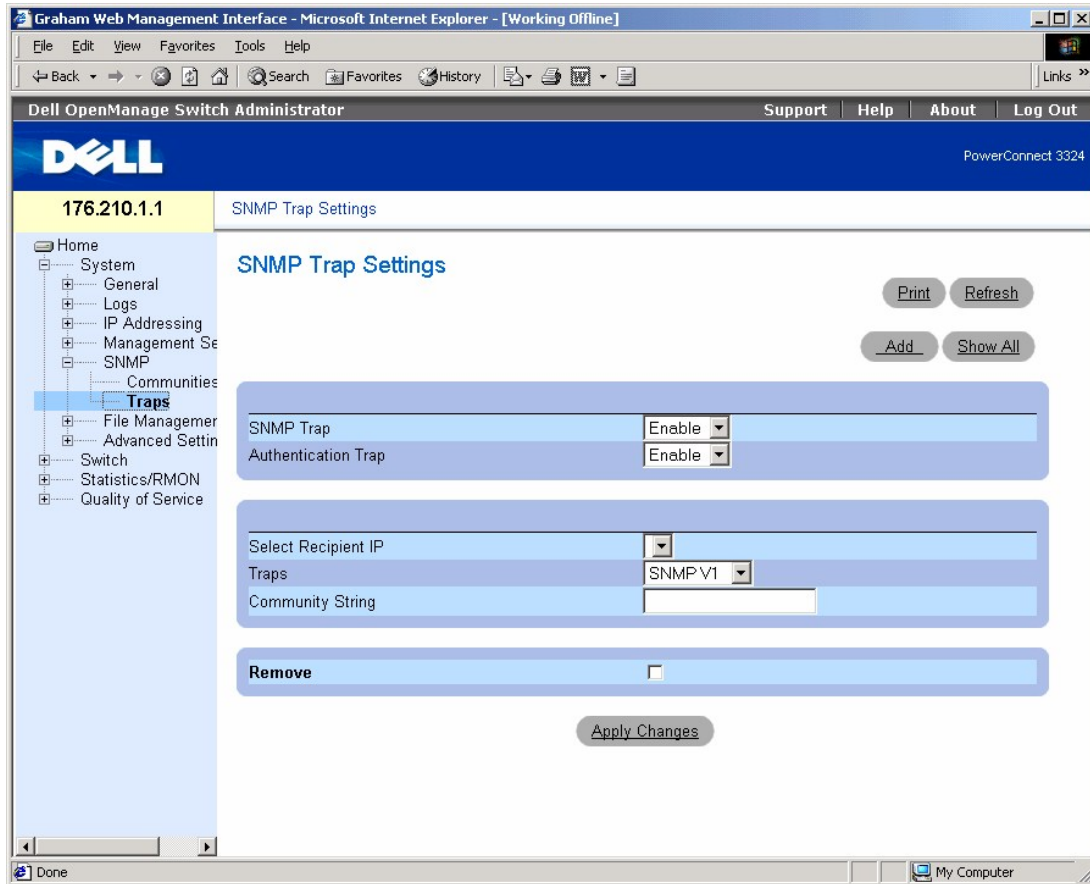

SNMP Trap Settings Page

The **SNMP Trap Settings** page contains the following fields:

- 1 **SNMP Trap**—Enables sending SNMP traps or SNMP notifications from the switch to defined trap recipients. The possible field values are:
 - o **Enable**—Enables sending SNMP traps or SNMP notifications.
 - o **Disable**—Stops all SNMP traps from being sent.
- 1 **Authentication Trap**—Enables sending SNMP traps when authentication fails to defined recipients. The possible field values are:
 - o **Enable**—Enables sending SNMP traps when authentication failed.
 - o **Disable**—Disables sending SNMP traps when authentication failed.
- 1 **Select Recipient IP**—Specifies the IP address to whom the traps are sent.
- 1 **Traps**—Determines the trap type sent to the selected recipient. The possible field values are:
 - o **SNMP V1**—Indicates SNMP Version 1 traps are sent.
 - o **SNMP V2c**—Indicates SNMP Version 2 traps are sent.
 - o **Disable**—Disables sending traps to the recipient.
- 1 **Community String**—Identifies the community string of the trap manager.
- 1 **Remove**—Removes **Trap Manager Table** entries.
 - o **Checked**—Removes the **Trap Manager Table** entry.
 - o **Unchecked**—Maintains the **Trap Manager Table** entry.

Enabling SNMP Traps on the device:

1. Open the **SNMP Trap Settings** page.

2. Select **Enable** in the **SNMP Trap** drop-down list.
3. Define the **Select Recipient IP**, **Traps**, and **Community String** fields.
4. Click **Apply Changes**. SNMP traps are enabled on the device.

Enabling Authentication Traps on the device:

1. Open the **SNMP Trap Settings** page.
2. Select **Enable** in the **Authentication Trap** drop-down list.
3. Define the **Select Recipient IP**, **Traps**, and **Community String** fields.
4. Click **Apply Changes**. Authentication traps are enabled on the device.

Adding a new Trap Recipient:

1. Open the **SNMP Trap Settings** page.
2. Click **Add**. The **Add Trap Receiver/Manager** page opens.

Add Trap Receiver/Manager

[Refresh](#)

Recipient IP Address	0.0.0.0	
Community String		
Trap Enable	SNMP V1	<input type="checkbox"/>

[Apply Changes](#)

Add Trap Receiver/Manager Page

3. Define the **Recipient IP Address**, **Community String**, and **Trap Enable** fields. (Note that 0.0.0.0 means "All", and the traps are broadcast.)
4. Click **Apply Changes**. the Trap Recipient/Manager is added, and the device is updated.

Displaying the Trap Managers Table:

The **Trap Managers Table** contains fields for configuring trap types.

1. Open the **Traps** page.
2. Click **Show All**. The **Traps Manager Table** page opens.

Trap Manager Table

	Recipient IP	Trap	Community String	Remove
1		SNMP V1		<input type="checkbox"/>

[Apply Changes](#)

Trap Managers Table Page

Deleting a Trap Manager Table entry:

1. Open the **SNMP Trap Settings** page.
2. Click **Show All**. The **Traps Manager Table** page opens.

3. Select a **Trap Managers Table** entry.
4. Check the **Remove** check box.
5. Click **Apply Changes**. The trap manager is deleted, and the device is updated.

Configuring Traps Using CLI Commands

The following table summarizes the equivalent CLI commands for viewing fields displayed in the **SNMP Trap Settings** page.

CLI Command	Description
<code>snmp-server enable traps</code>	Enables the switch to send SNMP traps or SNMP notifications.
<code>snmp-server trap authentication</code>	Enables the switch to send SNMP traps when authentication failed.
<code>snmp-server host host-addr community-string [1 2]</code>	Determines the trap type sent to the selected recipient.
<code>show snmp</code>	Displays the SNMP communications status.

The following is an example of the CLI commands:

```
Console (config)# snmp-server enable traps
```

```
Console (config)# snmp-server trap authentication
```

```
Console (config)# snmp-server host 10.1.1.1 trapRec 2
```

```
Console (config)# exit
```

```
Console# show snmp
```

```
Community-String Community-Access IP address
```

```
-----
```

```
public read only All
```

```
private read write 172.16.1.1
```

```
private read write 172.17.1.1
```

```
Traps are enabled.
```

```
Authentication trap is enabled.
```

```
Trap-Rec-Address Trap-Rec-Community Version
```

192.122.173.42 public 2

System Contact: Robert

System Location: Marketing

Managing Files

The **File Management** page device allows network managers to manage device software, the Image Files, and the Configuration Files. Files can be downloaded from a TFTP server.

File Management Overview

The configuration file structure consists of the following files:

- 1 Startup Configuration File—Retains the exact device configuration when the device is powered down or rebooted. The Startup file maintains configuration commands, and configuration commands from the Running Configuration file can be saved to the Startup file.
- 1 Running Configuration File—Contains all Startup file commands, as well as all commands entered during the current session. After the device is powered down or rebooted, all commands stored in the Running Configuration file are lost. During the startup process, all commands in the Startup file are copied to the Running Configuration file and applied to the device. During the session, all new commands entered are added to the commands existing in the Running Configuration file. Commands are not overwritten. To update the Startup file, before powering down the device, the Running Configuration file must be copied to the Startup Configuration file. The next time the device is restarted, the commands are copied back into the Running Configuration file from the Startup Configuration file.

 **NOTE:** Configuration commands are merged with the Running Configuration file and are immediately applied to the device.

- 1 Backup Configuration File—Contains a backup copy of the device configuration. The Backup file changes when the Running Configuration file or the Startup file is copied to the Backup file. The commands copied into the file replace the existing commands saved in the Backup file. The Backup file contents can be copied to either the Running Configuration or the Startup Configuration files.
- 1 Image Files—System images are saved in two FLASH files called images (Image 1 and Image 2). The active image stores the active copy, while the other image stores a second copy. The device boots and runs from the active image. If the active image is corrupt, the system automatically boots from the non-active image. This is a safety feature for faults occurring during the software upgrade process.

To open the **File Management** page:

- 1 Click **System > File Management** in the Tree View. The **File Management** page opens.

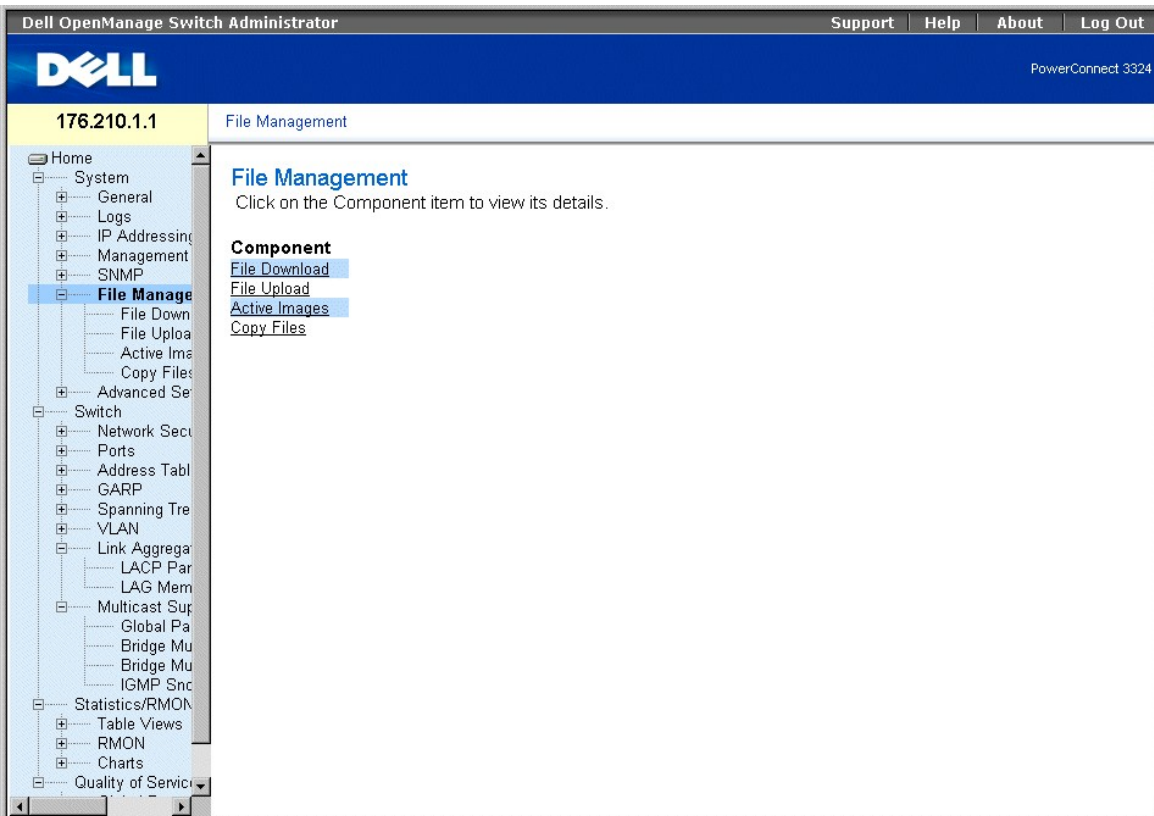

File Management Page

The **File Management** page contains links to:

- 1 [Downloading Files](#)
- 1 [Uploading Files](#)
- 1 [Resetting the Active Image](#)
- 1 [Copying and Deleting Files](#)

Downloading Files

The **File Download from Server** page contains fields for downloading image and Configuration Files from the TFTP server to the device. To open the **File Download from Server** page:

- 1 Click **System > File Management > File Download** in the Tree View. The **File Download from Server** page opens.

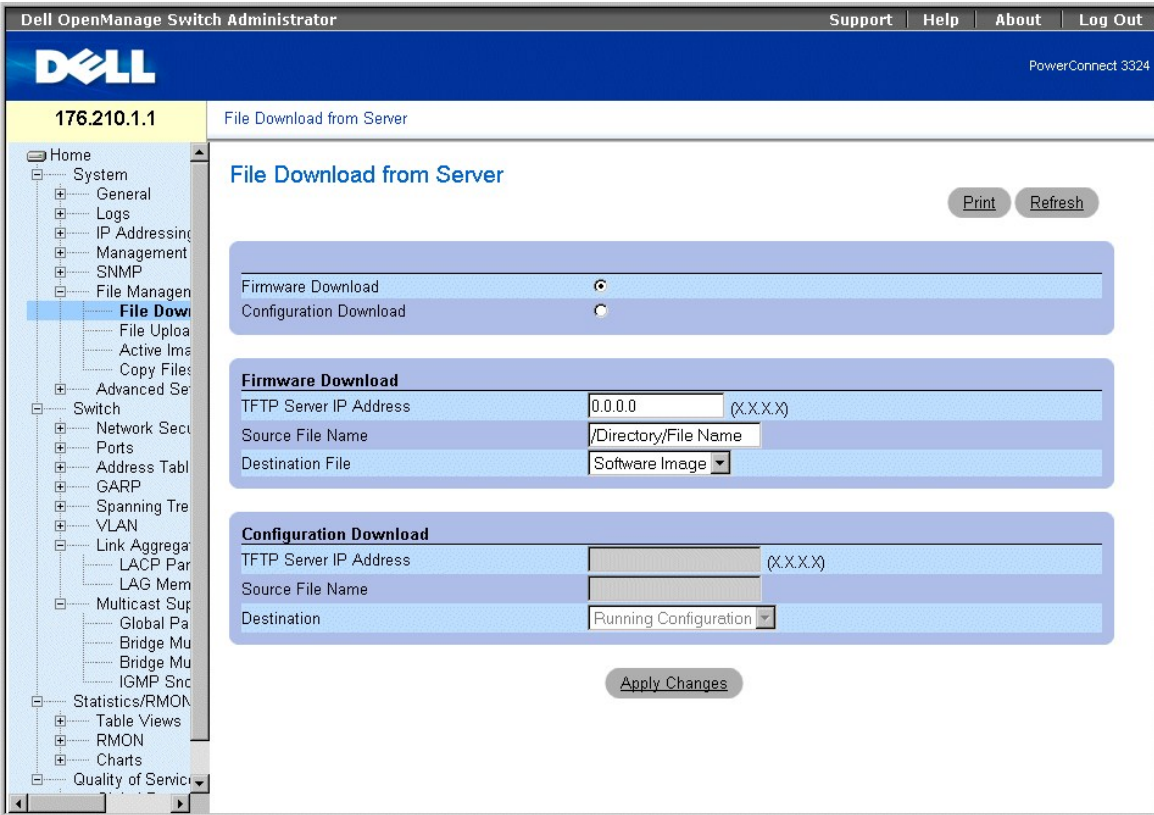

File Download From Server Page

The **File Download from Server** page contains the following fields:

1. **Firmware Download**—Indicates that the Firmware file is downloaded. If **Firmware Download** is selected, the **Configuration Download** fields are grayed out.
1. **Configuration Download**—Indicates that the Configuration file is downloaded. If **Configuration Download** is selected, the **Firmware Download** fields are grayed out.
1. **Firmware Download TFTP Server IP Address**—Indicates the TFTP Server IP Address from which files are downloaded.
1. **Firmware Download Source File Name**—Specifies the file to be downloaded.
1. **Firmware Download Destination File**—Indicates the destination file type to which to the file is downloaded. The possible field values are:
 - o **Software Image**—Downloads the Image file.
 - o **Boot Code**—Downloads the Boot file.
1. **Configuration Download File TFTP Server IP Address**—Indicates the TFTP Server IP Address through which the configuration files are downloaded.
1. **Configuration Download File Source File Name**—Specifies the configuration files to be downloaded.
1. **Configuration Download File Destination**—Indicates the destination file to which to the configuration files is downloaded. The possible field values are:
 - o **Running Configuration**—Downloads commands into the Running Configuration files.
 - o **Startup Configuration**—Downloads the Startup Configuration file and overwrites it.
 - o **Backup Configuration**—Downloads the Backup Configuration file and overwrites it.

Downloading files:

1. Open the **File Download from Server** page.
2. Define the file type to download.
3. Define the **TFTP Server IP Address**, **Source File Name**, and **Destination File** fields.
4. Click **Apply Changes**. The software is downloaded to the device.

NOTE: To activate the selected Image file, reset the device. For information on resetting the device, see "[Resetting the Device](#)".

Downloading Files Using CLI Commands

The following table summarizes the equivalent CLI commands for viewing fields displayed in the **File Download from Server** page.

CLI Command	Description
<code>copy source-url destination-url [snmp]</code>	Copies any file from a source to a destination.

The following is an example of the CLI commands:

```
console# copy running-config tftp://11.1.1.2/pp.txt
```

 **NOTE:** Each ! indicates that ten packets were successfully transferred.

```
Accessing file 'file1' on 172.16.101.101.
```

```
Loading file1 from 172.16.101.101: !!!!!!!!!!!!!!!!!!!!!!!!!!!!!!!!!!!!!!!!!!!!!!!!!!!!!!!!!!!!!
```

```
!!!!!!!!!!!!!!!!!!!!!!!!!!!!!!!!!!!!!!!!!!!!!!!!!!!!!!!!!!!!!!!!!!!!!!!!!!!!!!!!!!!!!!!!!!!!  
[OK]
```

```
Copy took 0:01:11 [hh:mm:ss]
```

Uploading Files

The **File Upload to Server** page contains fields for uploading the software from the TFTP server to the device. The Image file can also be uploaded from the **File Upload to Server** page. To open the **File Upload to Server** page:

- 1 Click **System > File Management > File Upload** in the Tree View. The **File Upload to Server** page opens:

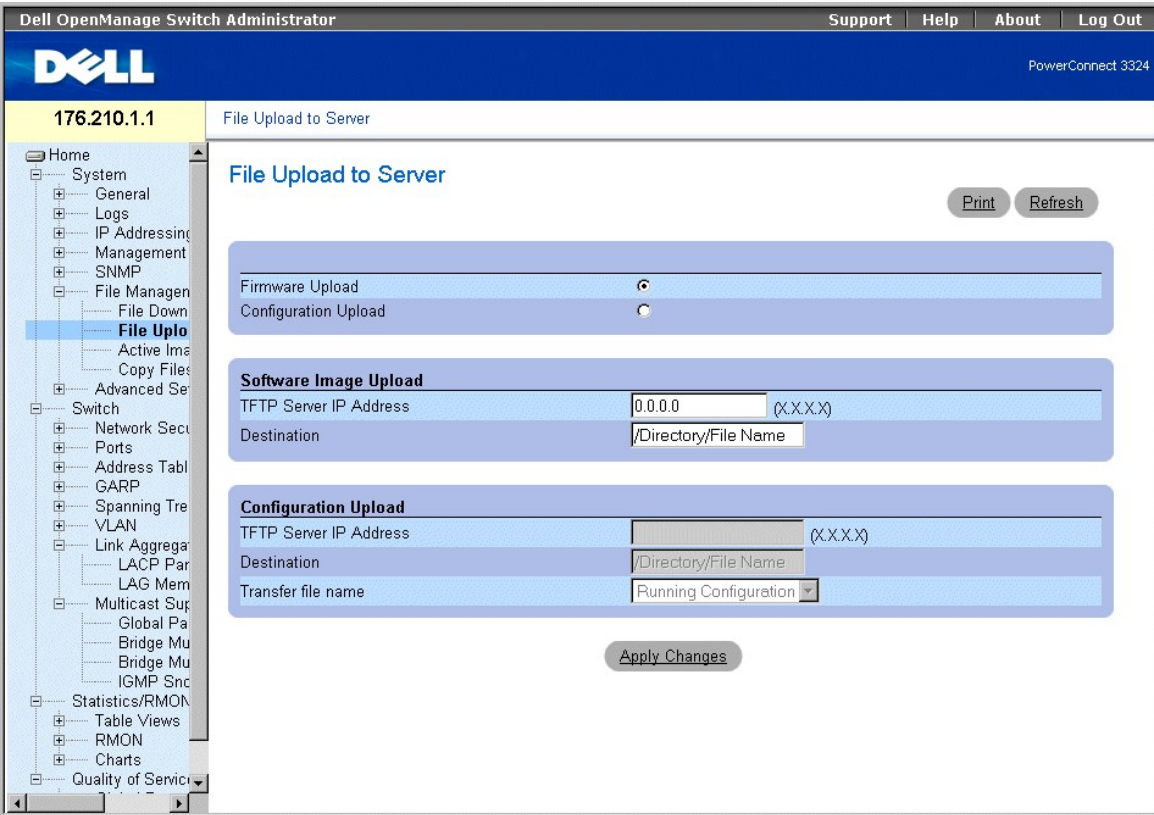

File Upload to Server Page

The **File Upload to Server** page contains the following fields:

1. **Firmware Upload**—Indicates that the Firmware file is uploaded. If **Firmware Upload** is selected, the **Configuration Upload** fields are grayed out.
1. **Configuration Upload**—Indicates that the Configuration file is uploaded. If **Configuration Upload** is selected, the **Software Image Upload** fields are grayed out.
1. **Software Image Upload TFTP Server IP Address**—Indicates the TFTP Server IP Address to which the Software Image is uploaded.
1. **Software Image Upload Destination**—Specifies the Software Image file path to which the file is uploaded.
1. **Configuration Upload TFTP Server IP Address**—Indicates the TFTP Server IP Address to which the Configuration file is uploaded.
1. **Configuration Upload Destination**—Specifies the Configuration file path from which the file is uploaded.
1. **Configuration Upload Transfer file name**—Indicates the software file to which the configuration is uploaded. The possible field values are:
 - o **Running Configuration**—Uploads the Running Configuration file.
 - o **Startup Configuration**—Uploads the Startup Configuration file.
 - o **Backup Configuration**—Uploads the Backup file.

Uploading files:

1. Open the **File Upload to Server** page.
2. Define the file type to upload.
3. Define the **TFTP Server IP Address**, **Destination**, and **Transfer file name** fields.
4. Click **Apply Changes**. The software is uploaded to the device.

Uploading Files Using CLI Commands

The following table summarizes the equivalent CLI commands for viewing fields displayed in the **File Upload to Server** page.

CLI Command	Description
copy source-url destination-url [snmp]	Copies any file from a source to a destination.

The following is an example of the CLI commands:

```
console# copy tftp://16.1.1.200/file1 image
```

```
!!!!!!!!!!!!!!!!!!!!!!!!!!!!!!!!!!!!!!!!!!!!!!!!!!!!!!!!!!!!!!!!!!!!!!!!!!!!!!!!!!!!!!!!!!!!!!!!!!!!!!!!!!!!!!!!!!!!!!!!!!!!!!!!!!!!!!
2883576 bytes copied in 00:00:10 [hh:mm:ss]
```

Resetting the Active Image

The **Active Images** page allows network managers to select and reset the Image files. The Active Image file for each unit in a stacking configuration can be individually selected. To open the **Active Images** page:

- 1 Click **System > File Management > Active Images** in the Tree View. The **Active Images** page opens.

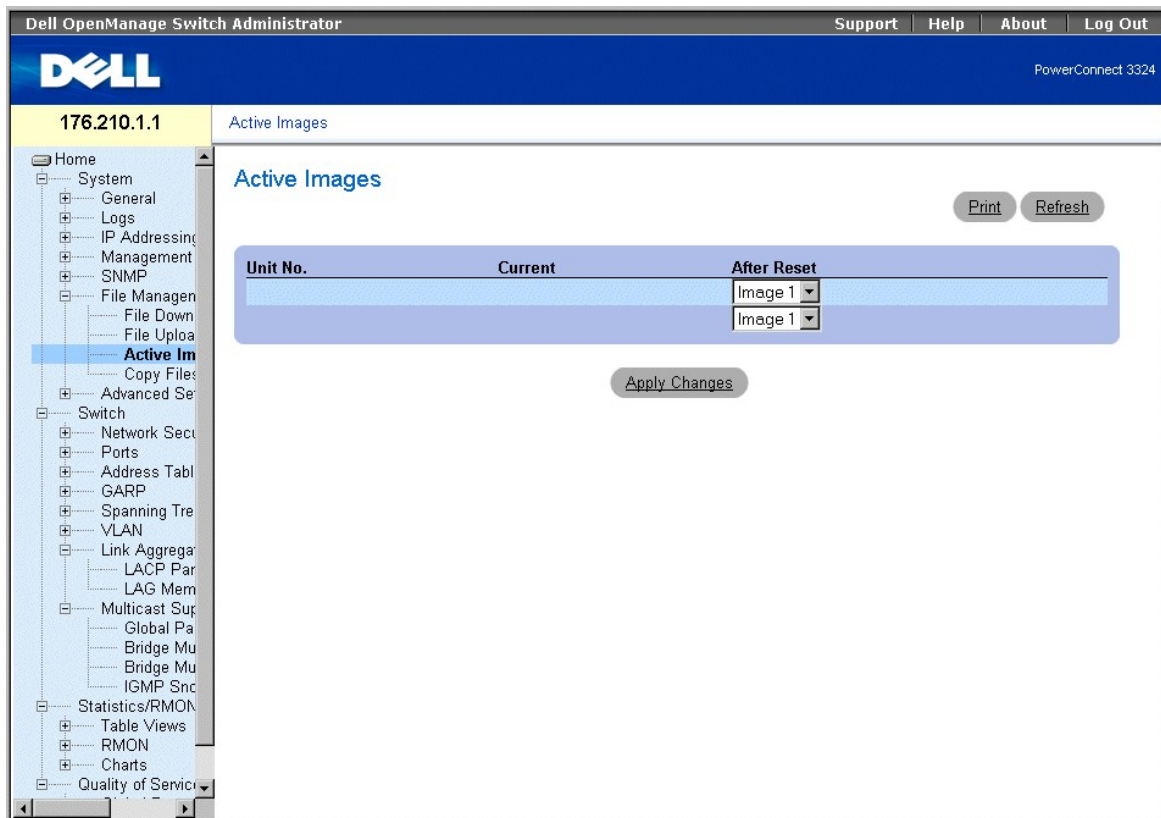

Active Images Page

The **Active Images** page contains the following fields:

- 1 **Unit No.**—Displays the unit number for which the Image file is selected.

- 1 **Current**—Displays the Image file which is currently active on the unit.
- 1 **After Reset**—Indicates the Image file which is active on the unit after the device is reset.

Selecting an Image File:

1. Open the **Active Images** page.
2. Select an Image file for a specific unit in the **After Reset** field.
3. Click **Apply Changes**. The Image file is selected. The Image file reloads only after the next reset. The currently selected Image file continue to run until the next device reset. For instruction on resetting the device, see "[Resetting the Device](#)".

Working with the Active Image File Using CLI Commands

The following table summarizes the equivalent CLI commands for viewing fields displayed in the **Active Images** page.

CLI Command	Description
<code>boot system [unit unit] {image-1 image-2}</code>	Specifies the system image that the device loads at startup.

The following is an example of the CLI commands:

```
Console# boot system image-1
```

Copying and Deleting Files

Files can be copied and deleted from the **Copy Files** page. To open the **Copy Files** page:

- 1 Click **System > File Management > Copy Files** in the Tree View. The **Copy Files** page opens.

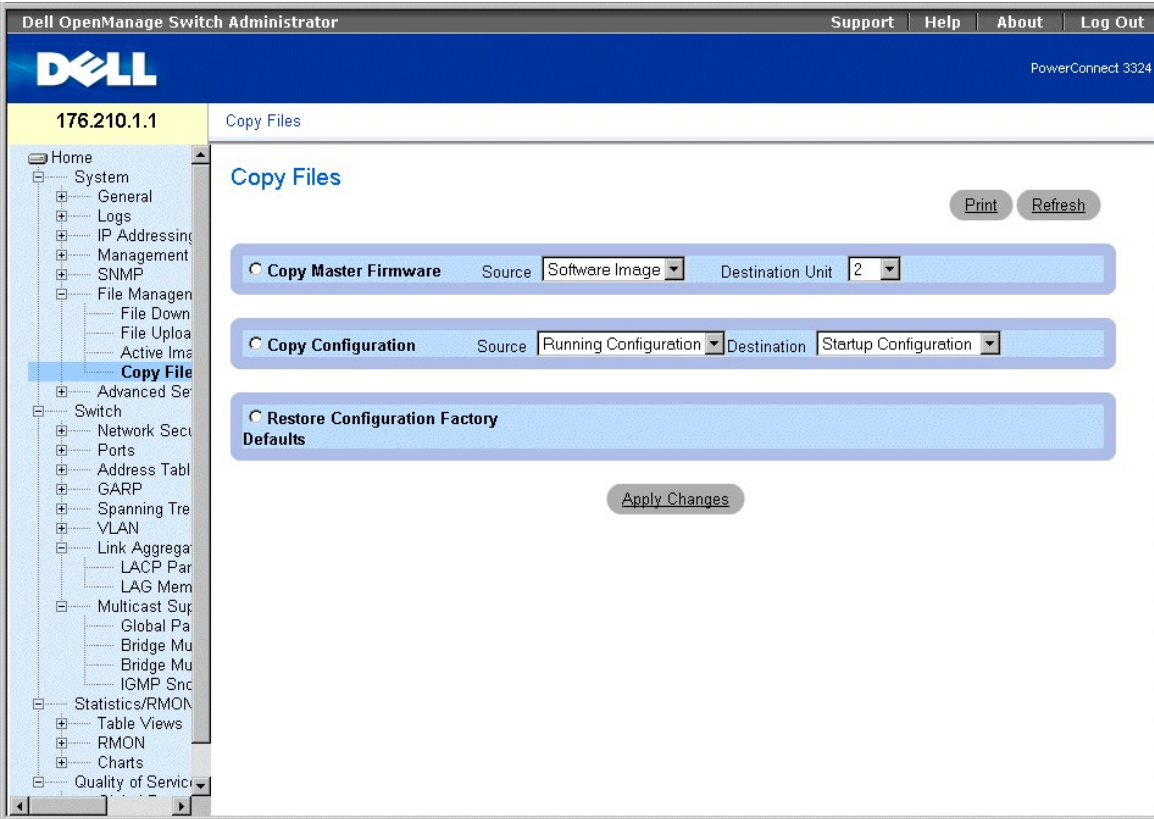

Copy Files Page

The **Copy Files** page contains the following fields:

1. **Copy Master Firmware**—Copies either the Software Image and/or Boot Code from the master unit to a selected stacking unit.
 - o **Source**—Copies either the Software Image or Boot Code files to the selected stacking unit.
 - o **Destination Unit**—Indicates the stacking unit to which the Software Image or Boot Code is copied.
1. **Copy Configuration**—Copies either the Running Configuration, Startup Configuration or Backup Configuration files to the Startup Configuration or Backup Configuration files.
 - o **Source**—Indicates either the Running Configuration, Startup Configuration, or Backup Configuration files to copy to the selected stacking unit.
 - o **Destination**—Indicates the configuration to overwrite, either the startup configuration or backup configuration.
1. **Restore Configuration Factory Defaults**—Restores the Factory Configuration default files by erasing the Startup-Config File. Note that the Backup-Config File is not erased. The possible field values are:
 - o **Checked**—Restores the factory defaults.
 - o **Unchecked**—Maintains the current configuration settings.

Copying Files:

1. Open the **Copy Files** page.
2. Select either the **Copy Configuration** or **Copy Master Firmware** field.
3. Define the **Source** and **Destination** fields for the file.
4. Click **Apply Changes**. The file is copied, and the device is updated.

Restoring Company Factory Default Settings:

1. Open the **Copy Files** page.
2. Select the **Restore Company Factory Defaults** fields.
3. Click **Apply Changes**. The company factory default settings are restored, and the device is updated.

Copying and Deleting Files Using CLI Commands

The following table summarizes the equivalent CLI commands for viewing fields displayed in the **Copy Files** page.

CLI Command	Description
<code>delete startup-config</code>	Deletes the startup-config file.
<code>copy source-url destination-url [snmp]</code>	Copies any file from a source to a destination

The following is an example of the CLI commands:

```
Console# delete startup-config
```

```
This command will reset the whole system and disconnect your Telnet session. Do you want to continue (y/n) [n]?
```

```
Console # copy tftp://172.16.101.101/file1 image
```

```
Accessing file 'file1' on 172.16.101.101.
```

```
Loading file1 from  
172.16.101.101: !!!!!!!!!!!!!!!!!!!!!!!!!!!!!!!!!!!!!!!!!!!!!!!!!!!!!!!!!!!!!!!!!!!!!!!!!!!!!!!!!!!!!!!!!!!!!!!!!!!!!!!!!!!!!!!!!!!!!!!!!  
[OK]
```

```
Copy took 0:01:11 [hh:mm:ss]
```

Defining Advanced Settings

Device Tuning is used to determine the maximum amount of entries allowed in the various tables listed. Changes are implemented only after the device is reset. To open the **Tuning** page:

- 1 Click **System > Advanced Settings** in the Tree View. The **Tuning** page opens.

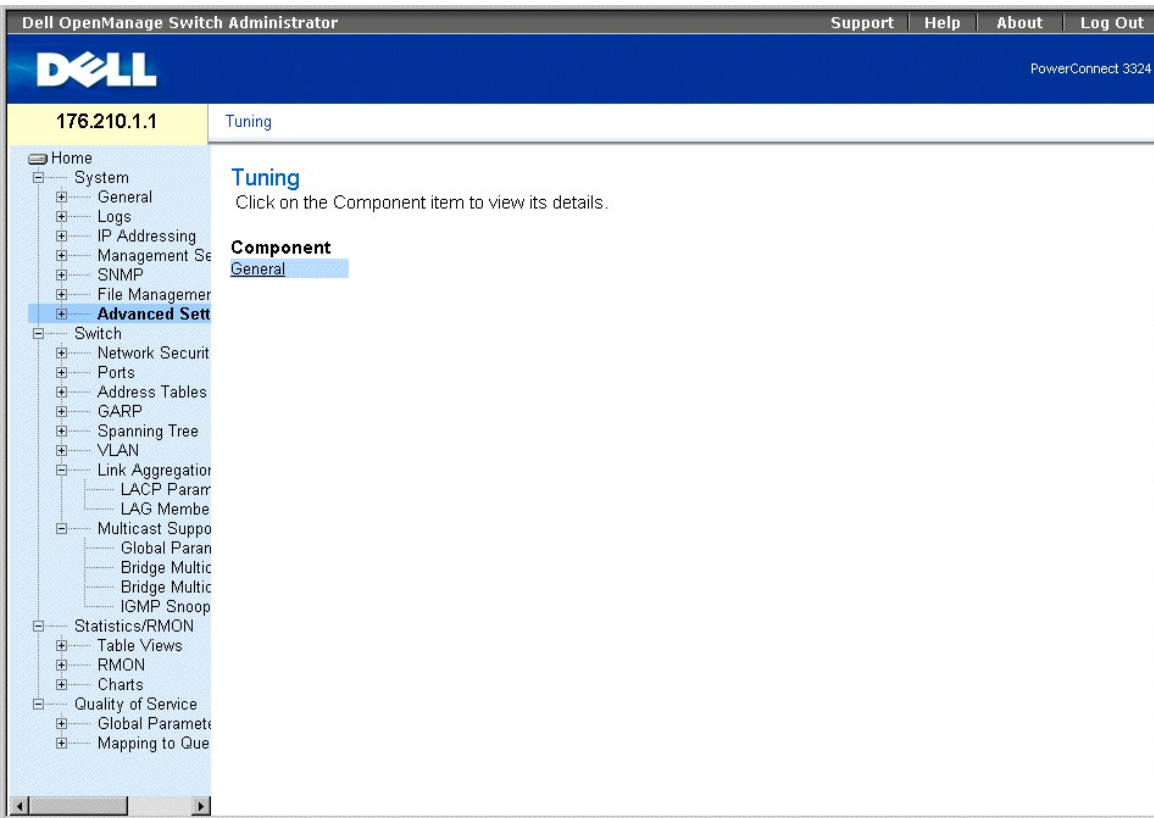

Tuning Page

The **Tuning** page contains the following link:

- 1 [Configuring General Device Tuning Parameters](#)

Configuring General Device Tuning Parameters

The **General Settings** page allows network managers to define general device parameters. To open the **General Settings** page:

- 1 Click **System** > **Advanced Settings** > **General** in the Tree View. The **General Settings** page opens.

The screenshot shows the Dell OpenManage Switch Administrator interface. The top navigation bar includes 'Support', 'Help', 'About', and 'Log Out'. The main content area is titled 'General Settings' and contains a table with the following data:

Attribute	Current	After Reset
Max RAM Log Entries (1-400)		200
Max VLANs when GVRP is enabled (1-256)	128	256

The interface also features a navigation tree on the left with categories like System, Switch, and Statistics/RMON. Buttons for 'Print', 'Refresh', and 'Apply Changes' are visible.

General Settings Page

The **General Settings** page contains the following columns:

- 1 **Attribute**—The general setting attribute.
- 1 **Current**—The current value.
- 1 **After Reset**—The future (after reset) value. By entering a value in the **After Reset** column, memory is allocated to the field table.

The **General Tuning** page contains the following fields:

- 1 **Max RAM Log Entries (1-400)**—Indicates the maximum number of RAM Log entries. When the Log entries are full, the log is cleared and the Log file is restarted.
- 1 **Max VLANs when GVRP is enabled (1-256)**—Defines the overall number of VLANs when GVRP is enabled.

NOTE: The maximum number of GVRP VLANs includes all the VLANs participating in GVRP operation, whether they are static or dynamic VLANs.

Viewing RAM Log Entries Counter Using the CLI Commands

The following table summarizes the equivalent CLI commands for viewing fields displayed in the **General Settings** page.

CLI Command	Description
<code>logging buffered size <i>number</i></code>	Sets the number of syslog messages stored in the internal buffer (RAM).
<code>gvrp max vlan</code>	Configures the maximum number of VLANs when GVRP is enabled.

The following is an example of the CLI commands:

Console (config)# logging buffered size 300

[Back to Contents Page](#)

[Back to Contents Page](#)

Getting Help

Dell™ PowerConnect™ 3324/3348 User's Guide

- [Technical Assistance](#)
 - [Dell Enterprise Training and Certification](#)
 - [Problems With Your Order](#)
 - [Product Information](#)
 - [Returning Items for Warranty Repair or Credit](#)
 - [Before You Call](#)
 - [Contacting Dell](#)
-

Technical Assistance

If you need assistance with a technical problem, use Dell's extensive suite of online services available at Dell Support at support.dell.com for help with installation and troubleshooting procedures.

For more information, see "[Online Services](#)."

If you still have not resolved the problem, call Dell for technical assistance.

 **NOTE:** Call technical support from a phone near or at the system so that technical support can assist you with any necessary procedures.

 **NOTE:** Dell's Express Service Code system may not be available in all countries.

When prompted by Dell's automated telephone system, enter your Express Service Code to route the call directly to the proper support personnel. If you do not have an Express Service Code, open the **Dell Accessories** folder, double-click the **Express Service Code** icon, and follow the directions.

For instructions on using the technical support service, see "[Technical Support Service](#)" and "[Before You Call](#)."

 **NOTE:** Some of the following services are not always available in all locations outside the continental U.S. Call your local Dell representative for information on availability.

Online Services

You can access Dell Support at support.dell.com. Select your region on the **WELCOME TO DELL SUPPORT** page, and fill in the requested details to access help tools and information.

You can contact Dell electronically using the following addresses:

- 1 World Wide Web

www.dell.com/

www.dell.com/ap/ (Asian/Pacific countries only)

www.euro.dell.com (Europe only)

www.dell.com/la (Latin American countries)

www.dell.ca (Canada only)

- 1 Anonymous file transfer protocol (FTP)

[ftp.dell.com/](ftp://ftp.dell.com/)

Log in as user: `anonymous`, and use your e-mail address as your password.

- 1 Electronic Support Service

support@us.dell.com

apsupport@dell.com (Asian/Pacific countries only)

support.euro.dell.com (Europe only)

- 1 Electronic Quote Service

sales@dell.com

apmarketing@dell.com (Asian/Pacific countries only)

sales_canada@dell.com (Canada only)

- 1 Electronic Information Service

info@dell.com

AutoTech Service

Dell's automated technical support service—AutoTech—provides recorded answers to the questions most frequently asked by Dell customers about their portable and desktop computer systems.

When you call AutoTech, use your touch-tone telephone to select the subjects that correspond to your questions.

The AutoTech service is available 24 hours a day, 7 days a week. You can also access this service through the technical support service. See the contact information for your region.

Automated Order-Status Service

To check on the status of any Dell™ products that you have ordered, you can go to support.dell.com, or you can call the automated order-status service. A recording prompts you for the information needed to locate and report on your order. See the contact information for your region.

Technical Support Service

Dell's technical support service is available 24 hours a day, 7 days a week, to answer your questions about Dell hardware. Our technical support staff use computer-based diagnostics to provide fast, accurate answers.

To contact Dell's technical support service, see "[Before You Call](#)" and then see the contact information for your region.

Dell Enterprise Training and Certification

Dell Enterprise Training and Certification is available; see www.dell.com/training for more information. This service may not be offered in all locations.

Problems With Your Order

If you have a problem with your order, such as missing parts, wrong parts, or incorrect billing, contact Dell for customer assistance. Have your invoice or packing slip available when you call. See the contact information for your region.

Product Information

If you need information about additional products available from Dell, or if you would like to place an order, visit the Dell website at www.dell.com. For the telephone number to call to speak to a sales specialist, see the contact information for your region.

Returning Items for Warranty Repair or Credit

Prepare all items being returned, whether for repair or credit, as follows:

1. Call Dell to obtain a Return Material Authorization Number, and write it clearly and prominently on the outside of the box.

For the telephone number to call, see the contact information for your region.

2. Include a copy of the invoice and a letter describing the reason for the return.
3. Include a copy of any diagnostic information indicating the tests you have run and any error messages reported by the system diagnostics.
4. Include any accessories that belong with the item(s) being returned (such as power cables, media such as CDs and diskettes, and guides) if the return is for credit.
5. Pack the equipment to be returned in the original (or equivalent) packing materials.

You are responsible for paying shipping expenses. You are also responsible for insuring any product returned, and you assume the risk of loss during shipment to Dell. Collect-on-delivery (C.O.D.) packages are not accepted.

Returns that are missing any of the preceding requirements will be refused at our receiving dock and returned to you.

Before You Call

 **NOTE:** Have your Express Service Code ready when you call. The code helps Dell's automated-support telephone system direct your call more efficiently.

If possible, turn on your system before you call Dell for technical assistance and call from a telephone at or near the computer. You may be asked to type some commands at the keyboard, relay detailed information during operations, or try other troubleshooting steps possible only at the system itself. Ensure that the system documentation is available.

 **CAUTION:** Before servicing any components inside your computer, see your *System Information Guide* for important safety information.

Contacting Dell

To contact Dell electronically, you can access the following websites:

- 1 www.dell.com
- 1 support.dell.com (technical support)
- 1 premiersupport.dell.com (technical support for educational, government, health care, and medium/large business customers, including Premier, Platinum, and Gold customers)

For specific web addresses for your country, find the appropriate country section in the table below.

NOTE: Toll-free numbers are for use within the country for which they are listed.

When you need to contact Dell, use the electronic addresses, telephone numbers, and codes provided in the following table. If you need assistance in determining which codes to use, contact a local or an international operator.

Country (City) International Access Code Country Code City Code	Department Name or Service Area, Website and E-Mail Address	Area Codes, Local Numbers, and Toll-Free Numbers
Anguilla	General Support	toll-free: 800-335-0031
Antigua and Barbuda	General Support	1-800-805-5924
Argentina (Buenos Aires)	Website: www.dell.com.ar	
International Access Code: 00	Tech Support and Customer Care	toll-free: 0-800-444-0733
Country Code: 54	Sales	0-810-444-3355
City Code: 11	Tech Support Fax	11 4515 7139
	Customer Care Fax	11 4515 7138
Aruba	General Support	toll-free: 800-1578
Australia (Sydney)	E-mail (Australia): au_tech_support@dell.com	
International Access Code: 0011	E-mail (New Zealand): nz_tech_support@dell.com	
Country Code: 61	Home and Small Business	1-300-65-55-33
City Code: 2	Government and Business	toll-free: 1-800-633-559
	Preferred Accounts Division (PAD)	toll-free: 1-800-060-889
	Customer Care	toll-free: 1-800-819-339
	Corporate Sales	toll-free: 1-800-808-385
	Transaction Sales	toll-free: 1-800-808-312
	Fax	toll-free: 1-800-818-341
Austria (Vienna)	Website: support.euro.dell.com	
International Access Code: 900	E-mail: tech_support_central_europe@dell.com	
Country Code: 43	Home/Small Business Sales	0820 240 530 00
City Code: 1	Home/Small Business Fax	0820 240 530 49
	Home/Small Business Customer Care	0820 240 530 14
	Preferred Accounts/Corporate Customer Care	0820 240 530 16
	Home/Small Business Technical Support	0820 240 530 14
	Preferred Accounts/Corporate Technical Support	0660 8779
	Switchboard	0820 240 530 00
Bahamas	General Support	toll-free: 1-866-278-6818
Barbados	General Support	1-800-534-3066
Belgium (Brussels)	Website: support.euro.dell.com	
International Access Code: 00	E-mail: tech_be@dell.com	
Country Code: 32	E-mail for French Speaking Customers: support.euro.dell.com/be/fr/emaildell/	
City Code: 2	Technical Support	02 481 92 88
	Customer Care	02 481 91 19
	Corporate Sales	02 481 91 00

	Fax	02 481 92 99
	Switchboard	02 481 91 00
Bermuda	General Support	1-800-342-0671
Bolivia	General Support	toll-free: 800-10-0238
Brazil	Website: www.dell.com/br	
International Access Code: 00	Customer Support, Technical Support	0800 90 3355
Country Code: 55	Tech Support Fax	51 481 5470
City Code: 51	Customer Care Fax	51 481 5480
	Sales	0800 90 3390
British Virgin Islands	General Support	toll-free: 1-866-278-6820
Brunei	Customer Technical Support (Penang, Malaysia)	604 633 4966
Country Code: 673	Customer Service (Penang, Malaysia)	604 633 4949
	Transaction Sales (Penang, Malaysia)	604 633 4955
Canada (North York, Ontario)	Online Order Status: www.dell.ca/ostatus	
International Access Code: 011	AutoTech (automated technical support)	toll-free: 1-800-247-9362
	TechFax	toll-free: 1-800-950-1329
	Customer Care (Home Sales/Small Business)	toll-free: 1-800-847-4096
	Customer Care (med./large business, government)	toll-free: 1-800-326-9463
	Technical Support (Home Sales/Small Business)	toll-free: 1-800-847-4096
	Technical Support (med./large bus., government)	toll-free: 1-800-387-5757
	Sales (Home Sales/Small Business)	toll-free: 1-800-387-5752
	Sales (med./large bus., government)	toll-free: 1-800-387-5755
	Spare Parts Sales & Extended Service Sales	1 866 440 3355
Cayman Islands	General Support	1-800-805-7541
Chile (Santiago)	Sales, Customer Support, and Technical Support	toll-free: 1230-020-4823
Country Code: 56		
City Code: 2		
China (Xiamen)	Tech Support website: support.ap.dell.com/china	
Country Code: 86	Tech Support E-mail: cn_support@dell.com	
City Code: 592	Tech Support Fax	818 1350
	Home and Small Business Technical Support	toll-free: 800 858 2437
	Corporate Accounts Technical Support	toll-free: 800 858 2333
	Customer Experience	toll-free: 800 858 2060
	Home and Small Business	toll-free: 800 858 2222
	Preferred Accounts Division	toll-free: 800 858 2557
	Large Corporate Accounts GCP	toll-free: 800 858 2055
	Large Corporate Accounts Key Accounts	toll-free: 800 858 2628
	Large Corporate Accounts North	toll-free: 800 858 2999
	Large Corporate Accounts North Government and Education	toll-free: 800 858 2955
	Large Corporate Accounts East	toll-free: 800 858 2020
	Large Corporate Accounts East Government and Education	toll-free: 800 858 2669
	Large Corporate Accounts Queue Team	toll-free: 800 858 2222
	Large Corporate Accounts South	toll-free: 800 858 2355
	Large Corporate Accounts West	toll-free: 800 858 2811
	Large Corporate Accounts Spare Parts	toll-free: 800 858 2621
Colombia	General Support	980-9-15-3978
Costa Rica	General Support	0800-012-0435
Czech Republic (Prague)	Website: support.euro.dell.com	
International Access Code: 00	E-mail: czech_dell@dell.com	
Country Code: 420	Technical Support	02 2186 27 27
City Code: 2	Customer Care	02 2186 27 11
	Fax	02 2186 27 14
	TechFax	02 2186 27 28
	Switchboard	02 2186 27 11
Denmark (Copenhagen)	Website: support.euro.dell.com	
International Access Code: 00	E-mail Support (portable computers): den_nbk_support@dell.com	
Country Code: 45	E-mail Support (desktop computers): den_support@dell.com	
	E-mail Support (servers): Nordic_server_support@dell.com	

	Technical Support	7023 0182
	Customer Care (Relational)	7023 0184
	Home/Small Business Customer Care	3287 5505
	Switchboard (Relational)	3287 1200
	Fax Switchboard (Relational)	3287 1201
	Switchboard (Home/Small Business)	3287 5000
	Fax Switchboard (Home/Small Business)	3287 5001
Dominica	General Support	toll-free: 1-866-278-6821
Dominican Republic	General Support	1-800-148-0530
Ecuador	General Support	toll-free: 999-119
El Salvador	General Support	01-899-753-0777
Finland (Helsinki)	Website: support.euro.dell.com	
International Access Code: 990	E-mail: fin_support@dell.com	
	E-mail Support (servers): Nordic_support@dell.com	
Country Code: 358	Technical Support	09 253 313 60
	Technical Support Fax	09 253 313 81
City Code: 9	Relational Customer Care	09 253 313 38
	Home/Small Business Customer Care	09 693 791 94
	Fax	09 253 313 99
	Switchboard	09 253 313 00
France (Paris) (Montpellier)	Website: support.euro.dell.com	
International Access Code: 00	E-mail: support.euro.dell.com/fr/fr/emaildell/	
Country Code: 33	Home and Small Business	
	Technical Support	0825 387 270
City Codes: (1) (4)	Customer Care	0825 823 833
	Switchboard	0825 004 700
	Switchboard (calls from outside of France)	04 99 75 40 00
	Sales	0825 004 700
	Fax	0825 004 701
	Fax (calls from outside of France)	04 99 75 40 01
	Corporate	
	Technical Support	0825 004 719
	Customer Care	0825 338 339
	Switchboard	01 55 94 71 00
	Sales	01 55 94 71 00
	Fax	01 55 94 71 01
Germany (Langen)	Website: support.euro.dell.com	
International Access Code: 00	E-mail: tech_support_central_europe@dell.com	
Country Code: 49	Technical Support	06103 766-7200
	Home/Small Business Customer Care	0180-5-224400
City Code: 6103	Global Segment Customer Care	06103 766-9570
	Preferred Accounts Customer Care	06103 766-9420
	Large Accounts Customer Care	06103 766-9560
	Public Accounts Customer Care	06103 766-9555
	Switchboard	06103 766-7000
Greece	Website: support.euro.dell.com	
International Access Code: 00	E-mail: support.euro.dell.com/gr/en/emaildell/	
Country Code: 30	Technical Support	080044149518
	Gold Technical Support	08844140083
	Switchboard	2108129800
	Sales	2108129800
	Fax	2108129812
Grenada	General Support	toll-free: 1-866-540-3355
Guatemala	General Support	1-800-999-0136
Guyana	General Support	toll-free: 1-877-270-4609
Hong Kong	Website: support.ap.dell.com	
International Access Code: 001	E-mail: ap_support@dell.com	
	Technical Support (Dimension™ and Inspiron™)	2969 3189
Country Code: 852	Technical Support (OptiPlex™, Latitude™, and Dell Precision™)	2969 3191

	Technical Support (PowerApp™, PowerEdge™, PowerConnect™, and PowerVault™)	2969 3196
	Gold Queue EEC Hotline	2969 3187
	Customer Advocacy	3416 0910
	Large Corporate Accounts	3416 0907
	Global Customer Programs	3416 0908
	Medium Business Division	3416 0912
	Home and Small Business Division	2969 3105
India	Technical Support	1600 33 8045
	Sales	1600 33 8044
Ireland (Cherrywood)	Website: support.euro.dell.com	
International Access Code: 16	E-mail: dell_direct_support@dell.com	
Country Code: 353	Technical Support	1850 543 543
City Code: 1	U.K. Technical Support (dial within U.K. only)	0870 908 0800
	Home User Customer Care	01 204 4014
	Small Business Customer Care	01 204 4014
	U.K. Customer Care (dial within U.K. only)	0870 906 0010
	Corporate Customer Care	1850 200 982
	Corporate Customer Care (dial within U.K. only)	0870 907 4499
	Ireland Sales	01 204 4444
	U.K. Sales (dial within U.K. only)	0870 907 4000
	Fax/SalesFax	01 204 0103
	Switchboard	01 204 4444
Italy (Milan)	Website: support.euro.dell.com	
International Access Code: 00	E-mail: support.euro.dell.com/it/it/emaildell/	
Country Code: 39	Home and Small Business	
City Code: 02	Technical Support	02 577 826 90
	Customer Care	02 696 821 14
	Fax	02 696 821 13
	Switchboard	02 696 821 12
	Corporate	
	Technical Support	02 577 826 90
	Customer Care	02 577 825 55
	Fax	02 575 035 30
	Switchboard	02 577 821
Jamaica	General Support (dial from within Jamaica only)	1-800-682-3639
Japan (Kawasaki)	Website: support.jp.dell.com	
International Access Code: 001	Technical Support (servers)	toll-free: 0120-198-498
Country Code: 81	Technical Support outside of Japan (servers)	81-44-556-4162
City Code: 44	Technical Support (Dimension™ and Inspiron™)	toll-free: 0120-198-226
	Technical Support outside of Japan (Dimension and Inspiron)	81-44-520-1435
	Technical Support (Dell Precision™, OptiPlex™, and Latitude™)	toll-free: 0120-198-433
	Technical Support outside of Japan (Dell Precision, OptiPlex, and Latitude)	81-44-556-3894
	Technical Support (Axim™)	toll-free: 0120-981-690
	Technical Support outside of Japan (Axim)	81-44-556-3468
	Faxbox Service	044-556-3490
	24-Hour Automated Order Service	044-556-3801
	Customer Care	044-556-4240
	Business Sales Division (up to 400 employees)	044-556-1465
	Preferred Accounts Division Sales (over 400 employees)	044-556-3433
	Large Corporate Accounts Sales (over 3500 employees)	044-556-3430
	Public Sales (government agencies, educational institutions, and medical institutions)	044-556-1469
	Global Segment Japan	044-556-3469
	Individual User	044-556-1760
	Switchboard	044-556-4300
Korea (Seoul)	Technical Support	toll-free: 080-200-3800
International Access Code: 001	Sales	toll-free: 080-200-3600
Country Code: 82	Customer Service (Seoul, Korea)	toll-free: 080-200-3800
	Customer Service (Penang, Malaysia)	604 633 4949

City Code: 2	Fax	2194-6202
	Switchboard	2194-6000
Latin America	Customer Technical Support (Austin, Texas, U.S.A.)	512 728-4093
	Customer Service (Austin, Texas, U.S.A.)	512 728-3619
	Fax (Technical Support and Customer Service) (Austin, Texas, U.S.A.)	512 728-3883
	Sales (Austin, Texas, U.S.A.)	512 728-4397
	SalesFax (Austin, Texas, U.S.A.)	512 728-4600 or 512 728-3772
Luxembourg	Website: support.euro.dell.com	
International Access Code: 00	E-mail: tech_be@dell.com	
Country Code: 352	Technical Support (Brussels, Belgium)	3420808075
	Home/Small Business Sales (Brussels, Belgium)	toll-free: 080016884
	Corporate Sales (Brussels, Belgium)	02 481 91 00
	Customer Care (Brussels, Belgium)	02 481 91 19
	Fax (Brussels, Belgium)	02 481 92 99
	Switchboard (Brussels, Belgium)	02 481 91 00
Macao	Technical Support	toll-free: 0800 582
Country Code: 853	Customer Service (Penang, Malaysia)	604 633 4949
	Transaction Sales	toll-free: 0800 581
Malaysia (Penang)	Technical Support	toll-free: 1 800 888 298
International Access Code: 00	Customer Service	04 633 4949
Country Code: 60	Transaction Sales	toll-free: 1 800 888 202
	Corporate Sales	toll-free: 1 800 888 213
Mexico	Customer Technical Support	001-877-384-8979 or 001-877-269-3383
International Access Code: 00	Sales	50-81-8800 or 01-800-888-3355
Country Code: 52	Customer Service	001-877-384-8979 or 001-877-269-3383
	Main	50-81-8800 or 01-800-888-3355
Montserrat	General Support	toll-free: 1-866-278-6822
Netherlands Antilles	General Support	001-800-882-1519
Netherlands (Amsterdam)	Website: support.euro.dell.com	
International Access Code: 00	E-mail (Technical Support):	
Country Code: 31	(Enterprise): nl_server_support@dell.com	
	(Latitude): nl_latitude_support@dell.com	
City Code: 20	(Inspiron): nl_inspiron_support@dell.com	
	(Dimension): nl_dimension_support@dell.com	
	(OptiPlex): nl_optiplex_support@dell.com	
	(Dell Precision): nl_workstation_support@dell.com	
	Technical Support	020 674 45 00
	Technical Support Fax	020 674 47 66
	Home/Small Business Customer Care	020 674 42 00
	Relational Customer Care	020 674 4325
	Home/Small Business Sales	020 674 55 00
	Relational Sales	020 674 50 00
	Home/Small Business Sales Fax	020 674 47 75
	Relational Sales Fax	020 674 47 50
	Switchboard	020 674 50 00
	Switchboard Fax	020 674 47 50
New Zealand	E-mail (New Zealand): nz_tech_support@dell.com	
International Access Code: 00	E-mail (Australia): au_tech_support@dell.com	

Country Code: 64	Home and Small Business	0800 446 255
	Government and Business	0800 444 617
	Sales	0800 441 567
	Fax	0800 441 566
Nicaragua	General Support	001-800-220-1006
Norway (Lysaker) International Access Code: 00 Country Code: 47	Website: support.euro.dell.com	
	E-mail Support (portable computers): nor_nbk_support@dell.com	
	E-mail Support (desktop computers): nor_support@dell.com	
	E-mail Support (servers): nordic_server_support@dell.com	
	Technical Support	671 16882
	Relational Customer Care	671 17514
	Home/Small Business Customer Care	23162298
	Switchboard	671 16800
	Fax Switchboard	671 16865
	Panama	General Support
Peru	General Support	0800-50-669
Poland (Warsaw) International Access Code: 011 Country Code: 48 City Code: 22	Website: support.euro.dell.com	
	E-mail: pl_support_tech@dell.com	
	Customer Service Phone	57 95 700
	Customer Care	57 95 999
	Sales	57 95 999
	Customer Service Fax	57 95 806
	Reception Desk Fax	57 95 998
	Switchboard	57 95 999
Portugal International Access Code: 00 Country Code: 351	Website: support.euro.dell.com	
	E-mail: support.euro.dell.com/pt/en/emailldell/	
	Technical Support	707200149
	Customer Care	800 300 413
	Sales	800 300 410 or 800 300 411 or 800 300 412 or 21 422 07 10
Puerto Rico	General Support	1-800-805-7545
St. Kitts and Nevis	General Support	toll-free: 1-877-441-4731
St. Lucia	General Support	1-800-882-1521
St. Vincent and the Grenadines	General Support	toll-free: 1-877-270-4609
Singapore (Singapore) International Access Code: 005 Country Code: 65	Technical Support	toll-free: 800 6011 051
	Customer Service (Penang, Malaysia)	604 633 4949
	Transaction Sales	toll-free: 800 6011 054
	Corporate Sales	toll-free: 800 6011 053
South Africa (Johannesburg) International Access Code: 09/091 Country Code: 27 City Code: 11	Website: support.euro.dell.com	
	E-mail: dell_za_support@dell.com	
	Technical Support	011 709 7710
	Customer Care	011 709 7707
	Sales	011 709 7700
	Fax	011 706 0495
Southeast Asian and Pacific Countries	Customer Technical Support, Customer Service, and Sales (Penang, Malaysia)	604 633 4810
Spain (Madrid) International Access Code: 00 Country Code: 34 City Code: 91	Website: support.euro.dell.com	
	E-mail: support.euro.dell.com/es/es/emailldell/	
	Home and Small Business	
	Technical Support	902 100 130
	Customer Care	902 118 540
	Sales	902 118 541
Switchboard	902 118 541	

	Fax	902 118 539
	Corporate	
	Technical Support	902 100 130
	Customer Care	902 118 546
	Switchboard	91 722 92 00
	Fax	91 722 95 83
Sweden (Upplands Vasby)	Website: support.euro.dell.com	
International Access Code: 00	E-mail: swe_support@dell.com	
Country Code: 46	E-mail Support for Latitude and Inspiron: Swe-nbk_kats@dell.com	
City Code: 8	E-mail Support for OptiPlex: Swe_kats@dell.com	
	E-mail Support for Servers: Nordic_server_support@dell.com	
	Technical Support	08 590 05 199
	Relational Customer Care	08 590 05 642
	Home/Small Business Customer Care	08 587 70 527
	Employee Purchase Program (EPP) Support	20 140 14 44
	Fax Technical Support	08 590 05 594
	Sales	08 590 05 185
Switzerland (Geneva)	Website: support.euro.dell.com	
International Access Code: 00	E-mail: swisstech@dell.com	
Country Code: 41	E-mail for French-speaking HSB and Corporate Customers: support.euro.dell.com/ch/fr/emaiddell/	
City Code: 22	Technical Support (Home and Small Business)	0844 811 411
	Technical Support (Corporate)	0844 822 844
	Customer Care (Home and Small Business)	0848 802 202
	Customer Care (Corporate)	0848 821 721
	Fax	022 799 01 90
	Switchboard	022 799 01 01
Taiwan	Technical Support (portable and desktop computers)	toll-free: 00801 86 1011
International Access Code: 002	Technical Support (servers)	toll-free: 0080 60 1256
Country Code: 886	Transaction Sales	toll-free: 0080 651 228
	Corporate Sales	toll-free: 0080 651 227
Thailand	Technical Support	toll-free: 0880 060 07
International Access Code: 001	Customer Service (Penang, Malaysia)	604 633 4949
Country Code: 66	Sales	toll-free: 0880 060 09
Trinidad/Tobago	General Support	1-800-805-8035
Turks and Caicos Islands	General Support	toll-free: 1-866-540-3355
U.K. (Bracknell)	Website: support.euro.dell.com	
International Access Code: 00	Customer Care website: support.euro.dell.com/uk/en/ECare/Form/Home.asp	
Country Code: 44	E-mail: dell_direct_support@dell.com	
City Code: 1344	Technical Support (Corporate/Preferred Accounts/PAD [1000+ employees])	0870 908 0500
	Technical Support (direct/PAD and general)	0870 908 0800
	Global Accounts Customer Care	01344 373 186
	Home and Small Business Customer Care	0870 906 0010
	Corporate Customer Care	01344 373 185
	Preferred Accounts (500-5000 employees) Customer Care	0870 906 0010
	Central Government Customer Care	01344 373 193
	Local Government & Education Customer Care	01344 373 199
	Health Customer Care	01344 373 194
	Home and Small Business Sales	0870 907 4000
	Corporate/Public Sector Sales	01344 860 456
	Home and Small Business Fax	0870 907 4006
Uruguay	General Support	toll-free: 000-413-598-2521
U.S.A. (Austin, Texas)	Automated Order-Status Service	toll-free: 1-800-433-9014
International Access Code: 011	AutoTech (portable and desktop computers)	toll-free: 1-800-247-9362
	Consumer (Home and Home Office)	

Country Code: 1	Technical Support	toll-free: 1-800-624-9896	
	Customer Service	toll-free: 1-800-624-9897	
	DellNet™ Service and Support	toll-free: 1-877-Dellnet (1-877-335-5638)	
	Employee Purchase Program (EPP) Customers	toll-free: 1-800-695-8133	
	Financial Services website: www.dellfinancialservices.com		
	Financial Services (lease/loans)	toll-free: 1-877-577-3355	
	Financial Services (Dell Preferred Accounts [DPA])	toll-free: 1-800-283-2210	
	Business		
	Customer Service and Technical Support	toll-free: 1-800-822-8965	
	Employee Purchase Program (EPP) Customers	toll-free: 1-800-695-8133	
	Projectors Technical Support	toll-free: 1-877-459-7298	
	Public (government, education, and healthcare)		
	Customer Service and Technical Support	toll-free: 1-800-456-3355	
	Employee Purchase Program (EPP) Customers	toll-free: 1-800-234-1490	
	Dell Sales	toll-free: 1-800-289-3355 or toll-free: 1-800-879-3355	
	Dell Outlet Store (Dell refurbished computers)	toll-free: 1-888-798-7561	
	Software and Peripherals Sales	toll-free: 1-800-671-3355	
	Spare Parts Sales	toll-free: 1-800-357-3355	
	Extended Service and Warranty Sales	toll-free: 1-800-247-4618	
	Fax	toll-free: 1-800-727-8320	
	Dell Services for the Deaf, Hard-of-Hearing, or Speech-Impaired	toll-free: 1-877-DELLTTY (1-877-335-5889)	
	U.S. Virgin Islands	General Support	1-877-673-3355
	Venezuela	General Support	8001-3605

[Back to Contents Page](#)

Getting Started

Dell™ PowerConnect™ 3324/3348 User's Guide

- [Starting the Switch Administrator](#)
 - [Understanding the Interface](#)
 - [Using the Switch Administrator Buttons](#)
 - [Using the CLI](#)
 - [Starting the CLI](#)
-

Starting the Switch Administrator

The Dell™ PowerConnect™ 3324/3348 Dell OpenManage™ Switch Administrator can be accessed from any PC with a web browser. To start the Switch Administrator:

1. Open a web browser.
2. Enter the device IP address/home.htm in the address bar and press <Enter>. A login window displays.

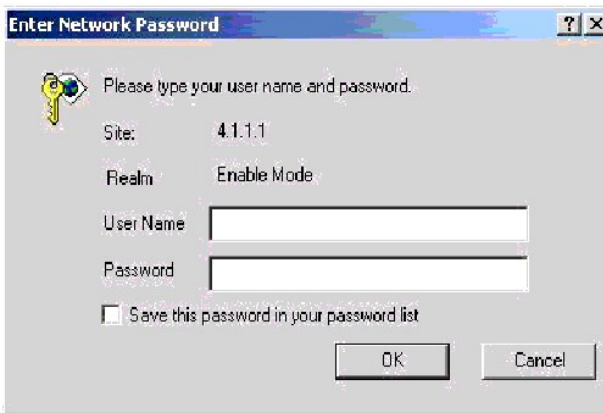

PowerConnect 3324/3348 Password Page

3. Enter a user name and password.

 **NOTE:** The PowerConnect 3324/3348 can be configured without a password being entered. Passwords are both case sensitive and alpha-numeric.

4. Click **OK**. The **Switch Administrator** home page displays.
-

Understanding the Interface

The **Switch Administrator** home page contains the following views:

1. **Tree View**—Located on the left side of the **Switch Administrator** home page, the Tree View provides an expandable tree view of the features and their components (Components List).
1. **Device View**— Located on the right side of the **Switch Administrator** home page, the Device View provides a view of the device, an information or table area, and configuration instructions.

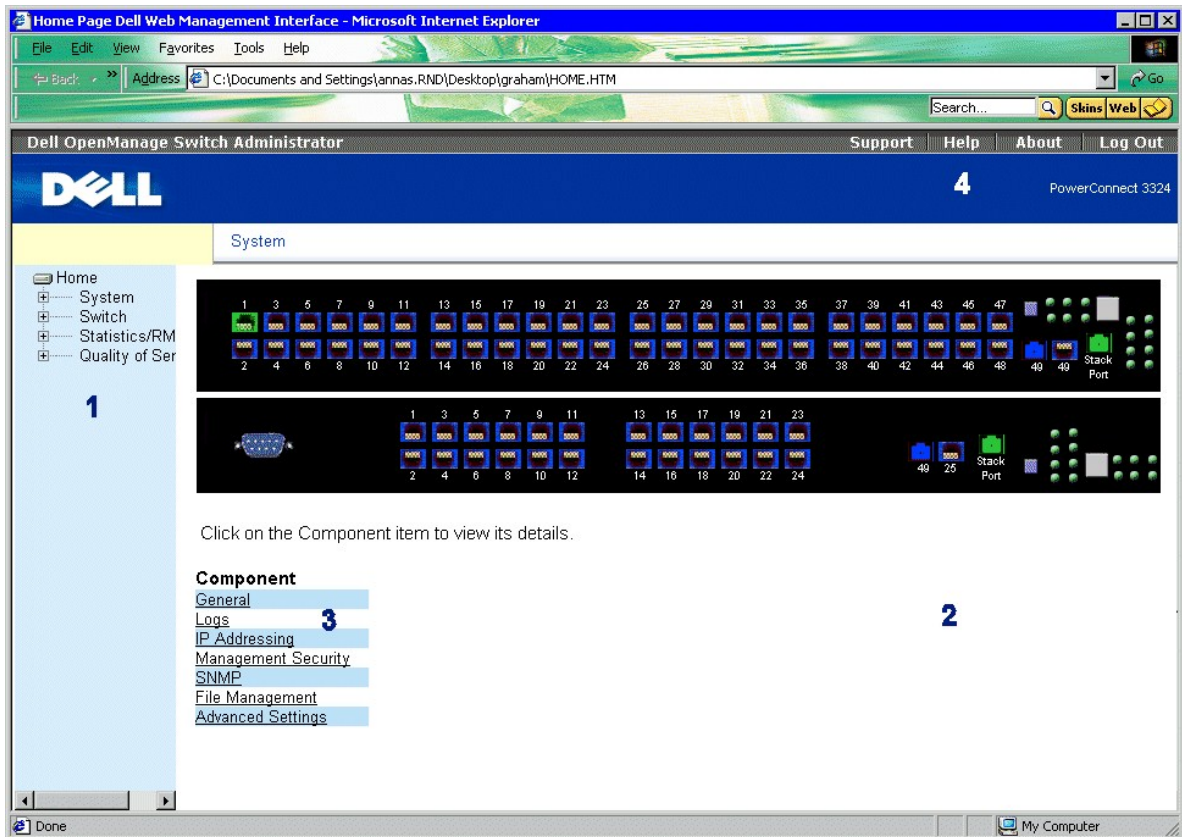

PowerConnect 3324/3348 Web Management Interface

The **PowerConnect 3324/3348 Interface Components Table** lists the interface components with their corresponding numbers:

Component	Name
1	Tree View. The Tree View contains a list of the different device features. For more information about the Tree View, see " Tree View ".
2	Device View. The Device View provides information about device ports, table information, and feature components. For more information about the Device View, see " Device View ".
3	Component List. The Component List contains a list of the feature components. For more information about using the components list, see " Component List ".
4	Information Buttons. The Information buttons provide access to PowerConnect device information and Dell Services. For more information about Information buttons, see " Using the Switch Administrator Buttons ".

PowerConnect 3324/3348 Interface Components Table

Tree View

The Tree View contains a list of the different features that can be configured including Switching features, Ports, Spanning Tree, VLANs, Class of Service, Link Aggregation (LAG), Multicast Support, and Statistics.

The branches in the Tree View can be expanded to view all the components under a specific feature or retracted to hide the feature's components.

Device View

The following section describes the different aspects of the Device View. The device provides information about the PowerConnect 3324/3348 switch. The Device View contains the following components:

- 1 [Component List](#)

- 1 [Device Representation](#)
- 1 [Work Desk](#)

Component List

The **Switch Administrator** home page displays a Component List that contains the feature's menu options. To display the Component's features:

- 1 Click a Component List item. The specific component page opens. For example, click **Switch** in the Tree View. The following page opens:

Component

- [General](#)
- [Logs](#)
- [IP Addressing](#)
- [Diagnostics](#)
- [Management Security](#)
- [SNMP](#)
- [File Management](#)
- [Advanced Settings](#)

Component List

Device Representation

The **Switch Administrator** home page contains a graphical representation of the PowerConnect 3324/3348 front panel.

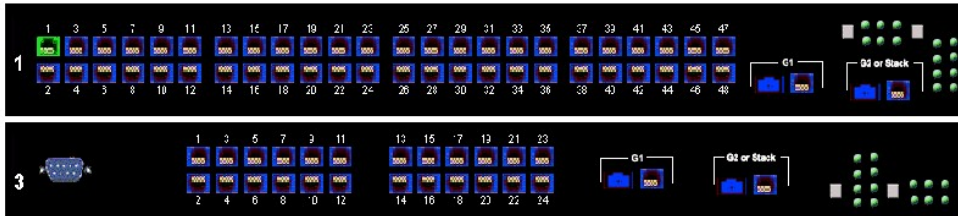

PowerConnect 3348

The port coloring indicates whether a specific port is currently active. Ports are reflected in the following colors:

Component	Name
Green	Indicates the port is connected.
Blue	Indicates the port is suspended due to a security function.
Red	Indicates that the port is disconnected.

PowerConnect 3324/3348 Port Indicators



NOTE: The LEDs are not reflected in the PowerConnect 3324/3348 front panel in the Switch Administrator. LED status can only be established by viewing the actual device. For more information about LED definitions, see "[LED Definitions](#)".

Work Desk

The Work Desk in the Device View provides a work area that contains device tables, general device information, and configurable device parameters. The figure below displays an example of a table that may display, if selected:

System Name	DELL Switch
System Contact	spk
System Location	R&D
MAC Address	00-10-B5-F4-00-01
Sys Object ID	
Date	11/10/02 (MM/DD/YY)
Time	09:30:00 (HH:MM:SS)
System Up Time	0 d 0 h 0 m 2 s

Unit No.	Service Tag	Asset Tag	Serial No.
1			

Example of Work Desk Information

Using the Switch Administrator Buttons

This section contains information about the different Dell OpenManage *Switch Administrator* buttons provided by the interface. The Switch Administrator provides the following buttons:

- 1. Information Buttons—Provides access to informational services including technical support, online help, information about the device, and closing the *Switch Administrator*.
- 1. About Page/Device Management Buttons—Provides an explanation of the management buttons that manage the *Switch Administrator* including add, delete, query, and apply changes buttons.

Information Buttons

The **Switch Administrator** home page contains the following information buttons:

Button	Description
Support	Opens the Dell Support Page. The Dell Technical Support Page URL is www.support.dell.com
Help	Opens the Online Help.
About	Opens the About page.
Log Out	Logs out of the Switch Administrator.

Information Buttons

Support Button

The **Support** page contains information for accessing Dell's technical support page.

- 1. Click **Support**. The **Dell Technical Support Page** opens:

WELCOME TO DELL SUPPORT



Dell Support in the United States. [Choose another region.](#)

Choose your need	
Personal or End User Support Dell's award-winning consumer support site is easy to use and catered to the needs to the personal or end user who is looking for basic support information. <ul style="list-style-type: none">▶ Home and Home Office▶ Small Business	I/T Professional or Premier Enterprise Support Dell's award-winning Premier support site is tailored to the demanding needs of our technical support professional, as well as, our gold and platinum support customers. <ul style="list-style-type: none">▶ Medium and Large Business▶ Federal Government▶ Provincial Government▶ Education▶ Healthcare

Dell Technical Support Page

2. Select the area that describes the support needed. The appropriate support page displays.
3. Enter a user name and password.
4. Click **Login** and complete the instructions.

 **NOTE:** Depending on the type of technical support required, a user name and password may be required.

Help Button

The **Online Help** page contains information to assist with configuring and managing the switch.

1. Click **Help**. The **Online Help** page opens.
2. Select a Help topic. The selected Help topic page opens.

 **NOTE:** Each screen contains a brief Help page. To access the Help, click **Help** on the Switch Administrator page.

About Button









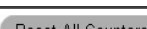

The **About** button opens the **About** page. The **About** page contain the device name, the software release number, and Dell copyright information. To access the **About** page:

1. Click **About**. The **About** page opens:



About PageDevice Management Buttons

The Switch Administrator management buttons allow network managers to easily configure PowerConnect from remote locations. The Switch Administrator contains the following management buttons:

Button	Description
	Applies set changes to the device.
	Adds information to tables or information windows.
	Starts a Telnet session.
	Queries tables.
	Displays the device tables.
	Transfers the firmware file from the device to the server.
	Moves information between lists.
	Refreshes device information.
	Opens the Log File Table page.
	Open the Log Ram Table page.
	Restarts the DHCP Client connections.

Add ACE to ACL	Adds ACEs to ACLs.
Add ACL	Adds ACLs.
Add List Name	Adds new lists.
Attach to Interface	Attaches assorted lists to interfaces.
Reset All Counters	Resets statistic counters.
Print	Prints the Network Management System page and/or table information.
Sort	Sorts table information.
Show Neighbors List	Displays the Neighbors List from the Neighbors Table page.
Restore Defaults	Restores the device default settings.
Draw	Creates Statistics charts on-the-fly.

Device Management Buttons

Using the CLI

This section contains an introduction to the Command Line Interface (CLI).

Command Mode

The CLI is divided into command modes. Each command mode has a specific command set. Entering a question mark ? at the system prompt (console prompt) displays a list of commands available for that particular command mode.

In each mode, a specific command is used to navigate from one command mode to another. The standards to access the modes are as follows:

- 1 User EXEC Mode
- 1 Privileged EXEC Mode
- 1 Global Configuration Mode
- 1 Interface Configuration Mode

During the CLI session initialization, the CLI mode is the User EXEC Mode. Only a limited subset of commands are available in the User EXEC Mode. This level is reserved for tasks that do not change the device configuration and is used to access configuration sub-systems such as the CLI. To enter the next level, the Privileged EXEC Mode, a password is required.

The Privileged EXEC Mode provides access to the device general configuration. For specific global configurations within the device, enter the next level, which is the Global Configuration Mode. A password is not required.

The Global Configuration Mode manages the device configuration on a global level. For specific configurations enter the next level, which is the Interface Configuration Mode. A password is not required.

The Interface Configuration Mode configures the device at the physical interface level. Interface commands that require subcommands have another level, which is the Subinterface Configuration Mode. A password is not required.

User EXEC Mode

After the logging on to the device, the User EXEC command mode is enabled. The user EXEC commands connect to remote devices, change terminal settings on a temporary basis, perform basic tests, and list system information.

To list the user EXEC commands enter the command ?.

The user-level prompt consists of the host name followed by the angle bracket (>).

```
console>
```

 **NOTE:** The default host name is `console` unless it has been modified during initial configuration.

Privileged EXEC Mode

This mode ensures that the Privileged access is password protected to prevent unauthorized use. Passwords are displayed on the screen as `*****` and are case sensitive.

To access and list the Privileged EXEC Mode commands:

1. At the prompt, enter the command `enable` and press <Enter>. A password prompt is displayed.
2. Enter the password and press <Enter>. The password is displayed as `*`. The privileged EXEC mode prompt is displayed. The Privileged EXEC Mode prompt consists of the device host name followed by the pound sign (#).

```
console#
```

1. To list the Privileged EXEC commands, enter the command ?.

To return from Privileged EXEC Mode to User EXEC Mode use:

1. `enable`
1. `disable`
1. `exit/end`
1. `Ctrl+Z`

The following example illustrates how to access privileged EXEC mode and return to the User EXEC mode:

```
console>enable
```

```
Enter Password: *****
```

```
console#
```

```
console#disable
```

```
console>
```

The `exit` command is used to move back from any mode to a previous level mode, for example, from Interface Configuration Mode to Global Configuration Mode, and from Global Configuration Mode to Privileged EXEC Mode.

Global Configuration Mode

Global Configuration commands apply to system features, rather than a specific protocol or interface. The Privileged EXEC Mode command `configure` is used to enter the Global Configuration Mode.

To access and list the Global Configuration Mode commands:

- 1 At the Privileged EXEC Mode prompt enter `configure` and press <Enter>. The Global Configuration Mode prompt is displayed. The Global Configuration Mode prompt consists of the device host name followed by the pound sign # and `(config)`.

```
console(config)#
```

- 1 To list the Global Configuration commands enter the command `?`.

To return from Global Configuration Mode to Privileged EXEC Mode, use one of the following commands:

- 1 `exit`
- 1 `Ctrl+Z`

The following example illustrates how to access Global Configuration Mode and return to the Privileged EXEC Mode:

```
console#  
  
console#configure  
  
console(config)#exit  
  
console#
```

Interface Configuration Mode

Interface configuration commands modify specific IP interface including bridge-group, description, and so on. The Interface Configuration Modes are:

- 1 VLAN—Contains commands to create and configure a VLAN as a whole, for example, to create a VLAN and apply an IP address to the VLAN.
- 1 Port Channel—Contains commands to configure individual ports, for example, assigning ports to a LAG.
- 1 Line Interface—Contains commands to configure the management connections. These include commands such as line speed and timeout settings.
- 1 IP Access-List—Contains commands to manage access lists. The commands create and maintain the lists.
- 1 Ethernet—Contains commands to manage port configuration.
- 1 Management Access List—Contains commands to define access lists for management. Access lists are used to manage access authorization and user authentication.
- 1 MAC List—Configures conditions required to allow traffic based on MAC addresses.

Starting the CLI

PowerConnect 3324/3348 can be managed over a direct connection to the console port or via a Telnet connection. PowerConnect 3324/3348 is managed by typing command keywords and parameters at the command prompt. Using the CLI is similar to entering commands on a UNIX system.

If access is via a Telnet connection, ensure the device has an IP address defined and that the workstation used to access the device is connected to the device prior to using CLI commands.

For more information about configuring an initial IP Address, see "[Initial Configuration](#)".

Console Connection

To start the CLI :

1. Start the device and wait until the startup prompt `Conso1e>` is displayed.
2. Configure the device and enter the necessary commands to complete the required tasks.
3. When finished, exit the session by entering `quit` or `exit`.

To log off the current user and log on a new user, type the login command in the Privileged EXEC command mode.

 **NOTE:** Telnet sessions are automatically disconnected after remaining idle for a user-defined time period.

Telnet Connection

Telnet is a terminal emulation TCP/IP protocol. ASCII terminals can be virtually connected to the local device through a TCP/IP protocol network. Telnet is an alternative to a local login terminal where a remote login is required.

PowerConnect 3324/3348 supports up to four simultaneous Telnet sessions. All CLI commands can be used over a telnet session.

To start a Telnet session:

1. Select **Start > Run**. The **Run** window opens.

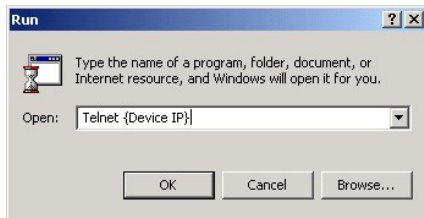

Run Windows

2. Type `te1net` and the device IP address in **Open** field.
3. Click **OK**. The Telnet session starts.



Telnet Window

[Back to Contents Page](#)

[Back to Contents Page](#)

Hardware Description

Dell™ PowerConnect™ 3324/3348 User's Guide

- [PowerConnect 3324/3348 Description](#)
 - [Ports Description](#)
 - [LED Definitions](#)
-

PowerConnect 3324/3348 Description

PowerConnect 3324/3348 Dimensions

This device has the following dimensions:

- 1 Width—19"
- 1 Height—1U

PowerConnect 3324/3348 Rear Panel

The rear panel of the Dell™ PowerConnect™ 3324/3348 is shown in the following figure:

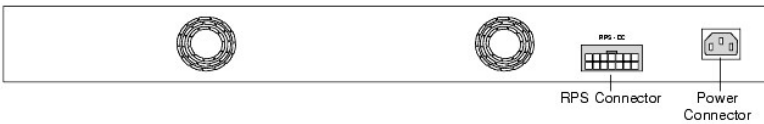

PowerConnect 3324 Rear Panel

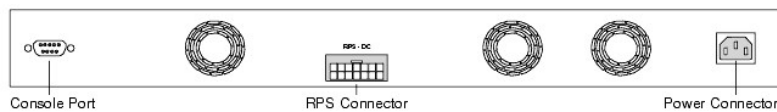

PowerConnect 3348 Rear Panel

PowerConnect 3324/3348 Components

This section describes different PowerConnect 3324/3348 hardware components, and includes the following topics:

- 1 [General Device Components](#)
- 1 [Mode Button](#)
- 1 [Stack ID Button](#)

General Device Components

The PowerConnect 3324/3348 includes the following hardware components:

- 1 CPU—Based on Motorola's MPC 8245.
- 1 FLASH—Contains 8 MB of FLASH Memory.
- 1 SDRAM—Contains 32 MB.

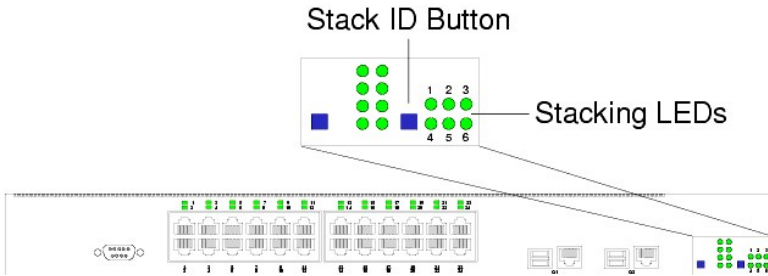

PowerConnect 3324 Front Panel

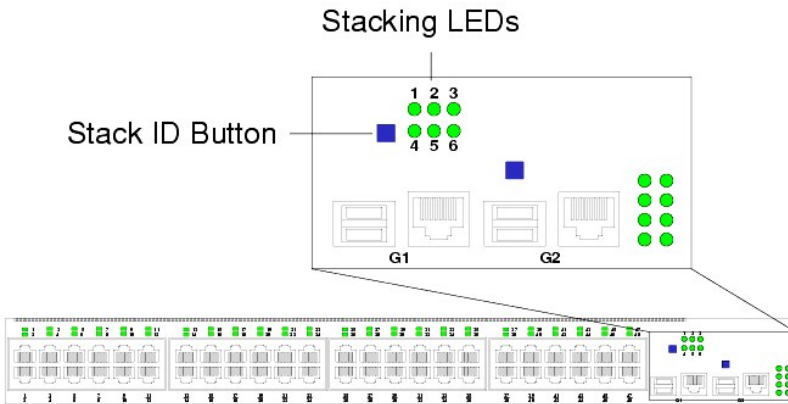

PowerConnect 3348 Front Panel

Mode Button

The **Mode** Button toggles between port activity and port duplex settings.

Stack ID Button

The PowerConnect 3324/3348 front panel contains a **Stack ID** button that permits network administrators to manually select the Stack Master and stack members.

NOTE: The Stack Master and stack members must be selected within 15 seconds after booting the device. If the Stack Master is not selected within 15 seconds, the device must be reset to select the Unit IDs.

Once the Stack Master is selected, the remaining devices are defined as stack members. Master units receive the Unit ID of 1. Stack members receive a separate Unit ID (2-6). For example, if there are 4 units in a stack, the Master unit is 1, the second stack member is 2, the third stack member is 3, and the fourth stack member is 4.

Stacking Modules and Connectors

PowerConnect 3324/3348 Stacking modules are connected to port G2. The Stack module is a mini GBIC module with two stacking connectors: RX and TX. RX is the lower connection point, and TX is the upper connection point. The module is connected to other stacking units using a stacking cable connection. The top unit's RX is connected to the lower unit's TX. This completes the Ring Topology. The Stacking Connections figure illustrates the Ring Topology.

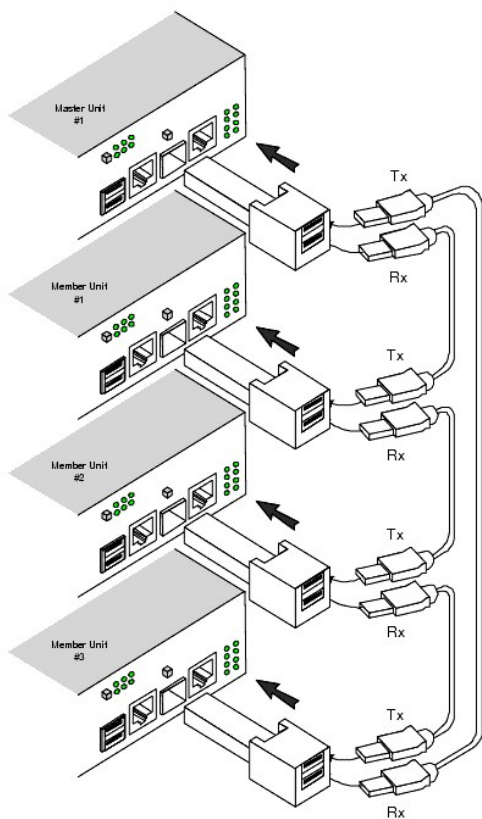

Stacking Connections

For more information about connecting Stacking cables, see ["Connecting Stacking Cables"](#).

Ports Description

Ethernet Port Description

The PowerConnect 3324 features 24 FE 10BaseT/100BaseTX UTP copper RJ45 ports per unit and 2 combo ports. The PowerConnect 3348 features 48 FE 10BaseT/100BaseTX UTP copper RJ45 ports per unit and 2 combo ports. Each combo port is a single logical port that has the following two physical interfaces:

- 1 1000Base-T connectors.
- 1 Mini-GBIC (SFP) connectors.

Only one of the two physical connections of a combo port may be used at any one time.

If auto-MDIX is enabled, PowerConnect 3324/3348 automatically detects and corrects the difference between crossover and straight-through cables on all ports.

PowerConnect 3324/3348 supports half and full duplex mode 10/100 M bps speed for copper ports.

Console Port Description

The console port interface supports synchronous data of eight data bits, one stop bit, and no parity. All RS232 pins are supported (9 pins) for Modem support.

LED Definitions

The front panel LEDs in the following figures indicate the status of port links and modes, power supply status, stacking status, and system diagnostics. The LED types are as follows:

- 1 Port LEDs
- 1 System LEDs
- 1 Stacking LEDs

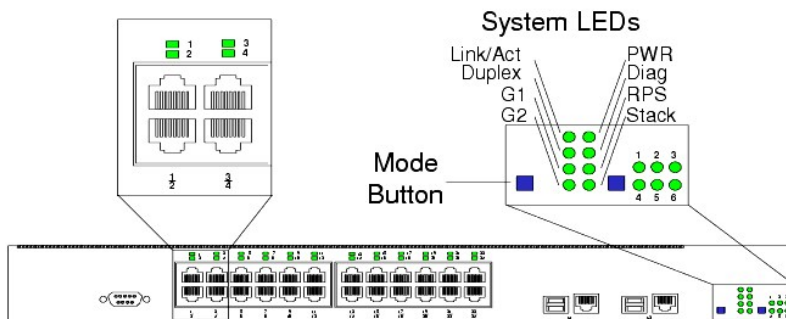

Front Panel LEDs: 24 Ports

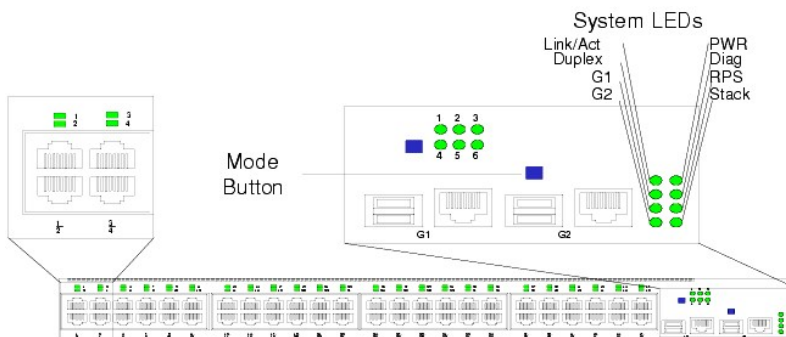

Front Panel LEDs: 48 Ports

Port LEDs

Each port has one corresponding LED located above the port. The LEDs show either link activity or duplex mode, depending on the port LED display mode. For information about setting the LED display mode, see ["System LEDs"](#).

Color	Activity	Definition
Green	Static	Port link up. Port operating at 100 Mbps.
Green	Flashing	Port link up with activity. Port operating at 100 Mbps.

Red	Static	Port link up. Port operating at 10 Mbps.
Red	Flashing	Port link up with activity. Port operating at 10 Mbps.
Off	Off	Port link down.

Port Link Activity

Color	Activity	Definition
Green	Static	Port full duplex.
Off	Off	Port link down or half duplex.

Port Duplex Mode

System LEDs

The eight system LEDs indicate the status of various aspects of the device:

- As shown in the front panel figures at the start of this section, the two system LEDs on the upper left side represent Link Activity and Duplex. These LEDs indicate whether the port LEDs are displaying link activity or duplex status.
- The two LEDs on the lower left-side of the figures show the link activity status of Giga Ports 1 and 2 as follows:

Color	Activity	Definition
Green	Static	Port link up. Port operating at 1000 Mbps.
Green	Flashing	Port link up with activity. Port operating at 1000 Mbps.
Red	Static	Port link up. Port operating at 10/100 Mbps.
Red	Flashing	Port link up with activity. Port operating at 10/100 Mbps.
Off	Off	Port link down.

Giga Port Link Activity Status

- The **Mode** button located next to the system LEDs is used to toggle between the two display modes. For an explanation of the port LEDs in each of these modes, see "[Port LEDs](#)".

When a power supply fails, an error message and several traps are generated. The status of each power supply is indicated by LEDs on the front panel.

- The four LEDs on the right side show the status of the power supplies, diagnostic mode, and stack mode as follows:

LED	Color	Activity	Definition
PWR	Green	Static	Power supply operational.
	Amber	Static	Power supply failure.
RPS	Green	Static	Redundant power supply operational.
	Amber	Static	Redundant power supply failure.
	Off	Off	Redundant power supply not present.
Diag	Green	Flashing	The system is currently in the Diagnostic mode.
Stack	Green	Static	Stacking successfully completed.
	Off	Off	Standalone.

Power, Diagnostic, and Stack LEDs

Stacking LEDs

The stacking LEDs indicate the unit's position in the stack. As shown in the front panel illustrations at the start of this section, the stacking LEDs are numbered 1 through 6. Each unit in the stack has one stacking LED lit, indicating its position in the stack. When stacking LED 1 is lit, the unit is the master unit. When one of the stacking LEDs numbered 2 through 6 is lit, the unit is the corresponding stacking member unit.

[Back to Contents Page](#)

Installing the PowerConnect 3324/3348 Switch

Dell™ PowerConnect™ 3324/3348 User's Guide

- [Installation Precautions](#)
 - [Site Requirements](#)
 - [Unpacking and Installation](#)
 - [Cable Port and Pinout Information](#)
-

Installation Precautions

- ⚠ **CAUTION:** The rack or cabinet housing the switch should be adequately secured to prevent it from becoming unstable and/or falling over.
 - ⚠ **CAUTION:** Ensure the power source circuits are properly grounded.
 - ⚠ **CAUTION:** Observe and follow service markings. Do not service any product except as explained in your system documentation. Opening or removing covers marked with a triangular symbol with a lightning bolt may cause electrical shock. These components are to be serviced by trained service technicians only.
 - ⚠ **CAUTION:** Ensure the power cable, extension cable, and/or plug is not damaged.
 - ⚠ **CAUTION:** Ensure the product is not exposed to water.
 - ⚠ **CAUTION:** Do not push foreign objects into the device, as it may cause a fire or electric shock.
 - ⚠ **CAUTION:** Allow the product to cool before removing covers or touching internal equipment.
 - ⚠ **CAUTION:** Ensure the switch does not overload the power circuits, wiring, and over-current protection. To determine the possibility of overloading the supply circuits, add together the ampere ratings of all switches installed on the same circuit as the switch. Compare this total with the rating limit for the circuit. The maximum ampere ratings are usually printed on the switch, near their AC power connectors.
 - ➡ **NOTICE:** Ensure the device is not exposed to radiators and/or heat sources.
 - ➡ **NOTICE:** Ensure the cooling vents are not blocked.
 - ➡ **NOTICE:** Use the device only with approved equipment.
 - ➡ **NOTICE:** Do not install the switch in an environment where the operating ambient temperature might exceed 40°C (122°F).
 - ➡ **NOTICE:** Ensure the air flow around the front, sides, and back of the switch is not restricted.
-

Site Requirements

Dell™ PowerConnect™ 3324/3348 series equipment can be mounted in a standard 19-inch equipment rack or placed on a table. Before installing the unit, verify that the location chosen for installation meets the site requirements described below.

- 1 General—Ensure that the power supply is correctly installed.
 - 1 Power—The unit is installed within 1.5 m (5 feet) of a grounded, easily accessible outlet 100-250 VAC, 50-60 Hz. It is preferred that two separate power supplies are provided, for example, a UPS and a separated phased supply.
 - 1 Clearance—There is adequate frontal clearance for operator access. Allow clearance for cabling, power connections, and ventilation.
 - 1 Cabling—Cabling is routed to avoid sources of electrical noise such as radio transmitters, broadcast amplifiers, power lines, and fluorescent lighting fixtures.
 - 1 Ambient Requirements—The ambient unit operating temperature range is 0 to 40°C (32 to 122°F) at a relative humidity of up to 95%, non-condensing. Verify that water or moisture cannot enter the case of the unit.
-

Unpacking and Installation

Package Contents

While unpacking PowerConnect 3324/3348, ensure that the following items are included:

- 1 The PowerConnect 3324/3348 device.
- 1 An AC power cable.
- 1 Null modem cable.
- 1 Self-adhesive rubber pads.
- 1 Rack mount kits for rack installation.
- 1 Documentation CD.

Unpacking

 **NOTE:** Before unpacking the PowerConnect 3324/3348 switch, inspect the package and report any evidence of damage immediately.

1. Ground yourself by putting on an ESD wrist strap and attaching the ESD clip to a metal surface.
2. Place the container on a clean flat surface and cut all straps securing the container.
3. Open the container or remove the container top.
4. Carefully remove the unit from the container and place it on a secure and clean surface.
5. Remove all packing material.
6. Inspect the product for damage. Report any damage immediately. For information about contacting Dell, see "[Getting Help](#)".

Device Rack Installation

 **CAUTION:** Disconnect all cables from the unit before mounting the PowerConnect 3324/3348 switch in a rack or cabinet.

Installing PowerConnect 3324/3348:

1. Ground yourself by putting on an ESD wrist strap and attaching the ESD clip to a metal surface.
2. Place the PowerConnect 3324/3348 switch on a flat and stable surface.
3. Place the supplied rack-mounting bracket on one side of the PowerConnect 3324/3348. Ensure that the mounting holes on the PowerConnect 3324/3348 line up with the mounting holes on the rack-mounting bracket.
4. Insert the supplied screws into the rack-mounting holes and tighten with a Phillips screwdriver.
5. Repeat the process for the rack-mounting bracket on the other side of PowerConnect 3324/3348.
6. Insert the unit into the 19-inch rack and secure the unit to the rack with the rack screws (not provided by the PowerConnect 3324/3348 supplier). When securing, fasten the lower pair of screws before the upper pair of screws to ensure that the weight of the unit is evenly distributed during installation. Ensure that the ventilation holes are not obstructed.

Installing the Switch without a Rack

The PowerConnect 3324/3348 must be installed on a flat surface if it is not installed on a rack. The surface must be able to support the weight of the device and the device cables.

1. Set PowerConnect 3324/3348 on a flat surface, leaving 2 inches on each side and 5 inches at the back.
2. Ensure that the device has proper ventilation.
3. Attach the rubber feet to the bottom of the device to prevent the device from slipping.

Stacking PowerConnect 3324/3348

PowerConnect 3324/3348 supports stacking up to six PowerConnect 3324/3348 devices or up to 192 Fast Ethernet ports and six Giga ports. Each

PowerConnect 3324/3348 stack contains a single Master unit, while the remaining units are considered stacking members. All management is done through the Master unit. Both 24-port and 48-port devices can be included in the stack.

To enable stacking, units must be stacked with a Stack Module connected to port G2 in the SFP slot.

Connecting Stacking Cables

1. Place each device in the rack or on a flat surface.
2. Insert a stacking connector for each G2 port.

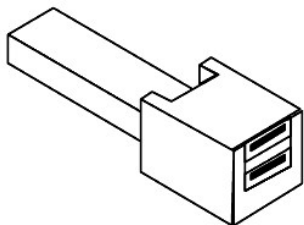

USB Connector

3. Connect the Master unit lower RX stacking connector to the selected member upper TX port.
4. Connect the stack in a stacking ring topology, where stacking cables are connected from the lower RX stacking connector into the upper TX Stacking connector.
5. Ensure that the upper and lower stack members are connected via a stacking cable. The following figure depicts a correctly connected stack:

NOTE: If the Stacking ring is not completed, the stack does not function.

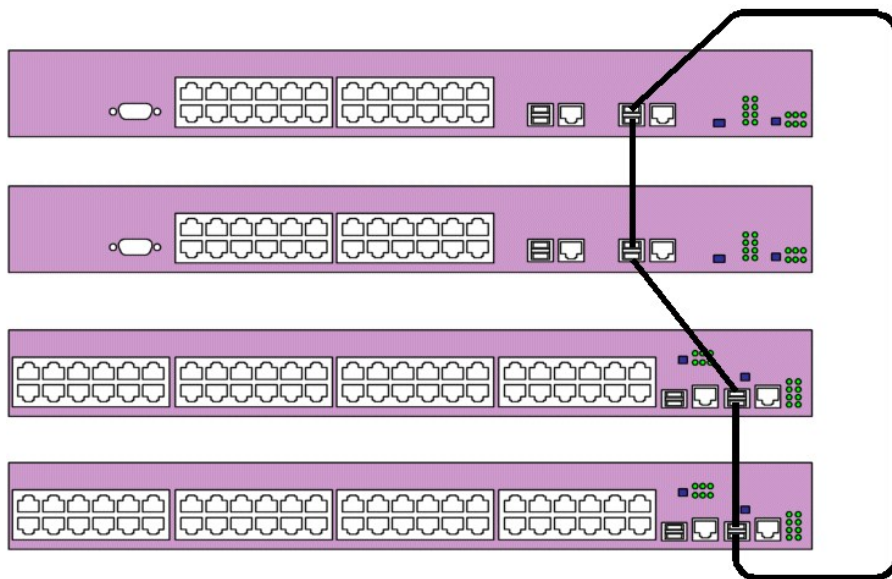

Connected Stack

For more information on configuring stacks, see "[Configuring Stacking](#)".

Connecting the PowerConnect 3324/3348 to a Power Supply

The following section contains instruction for connecting the PowerConnect 3324/3348 to a AC power connection. The PowerConnect 3324/3348 is supplied with power from:

- 1 AC power supply source.
- 1 An optional PowerConnect RPS-600 redundant power supply.
- 1 Both AC and DC sources.

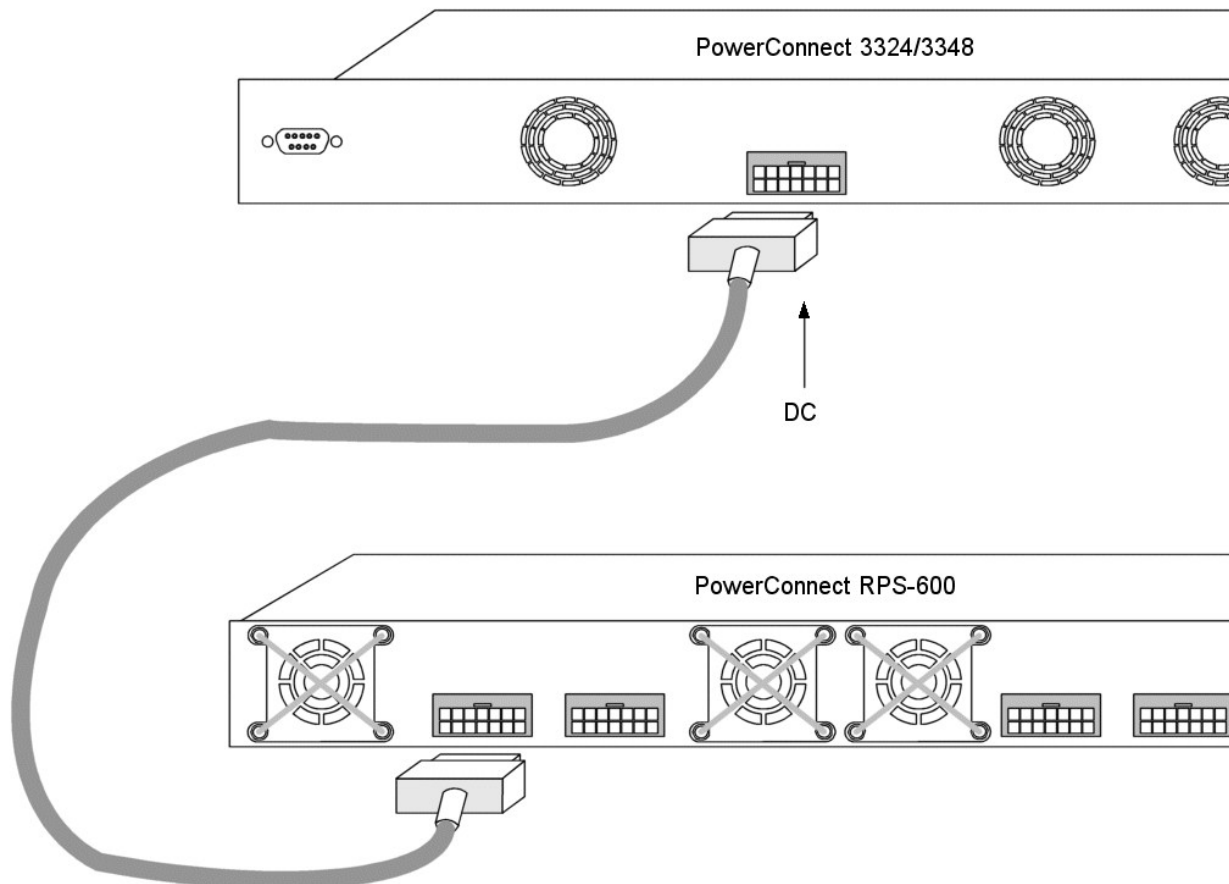

Connecting PowerConnect 3324/3348 to a Power Supply

- 1 Plug in the PowerConnect 3324/3348 to one of the previously listed power sources.

AC Power Connection

AC power should be supplied to the unit through a 1.5m (5 foot) standard power cable with safety-ground connected.

To connect power to PowerConnect 3324/3348:

1. Connect the power cable to the AC main socket located on the rear panel. If there is a redundant power module, connect this redundant power module cable to a separate power supply.
2. Connect the power cable to a grounded AC outlet.
3. Confirm that the device is connected and operating correctly by examining the LEDs on the front panel. For more information about LEDs, see "[LED Definitions](#)".

Cable, Port, and Pinout Information

This section describes the PowerConnect 3324/3348 physical interfaces and provides information about cable connections. Stations are connected to PowerConnect 3324/3348 ports through the physical interface ports on the front panel. For each station, the appropriate mode (Half/Full Duplex, Auto) is set.

Port Connections

The ports are all standard RJ45 Ethernet ports. Switching ports can connect to stations wired in standard RJ45 Ethernet station mode using straight cables. Transmission devices use crossed cables to connect to each other.

The following figure illustrates the RJ45 pin number allocations for the 10/100M ports.

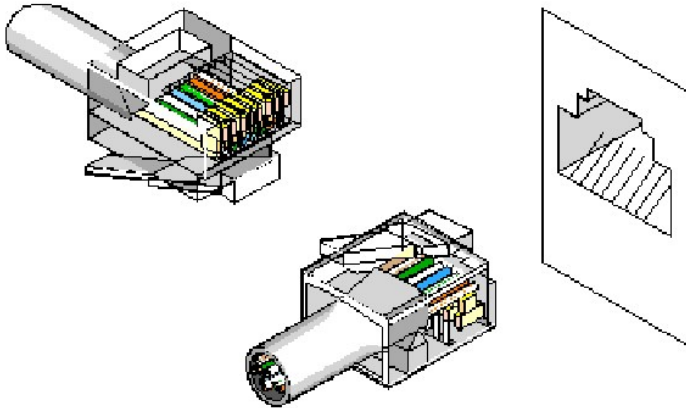

RJ45 Pin Number Allocation

Pin	Use
1	RX +
2	RX -
3	TX +
4	
5	--
6	TX -
7	-
8	-

The following figure illustrates the Gigaport Connector:

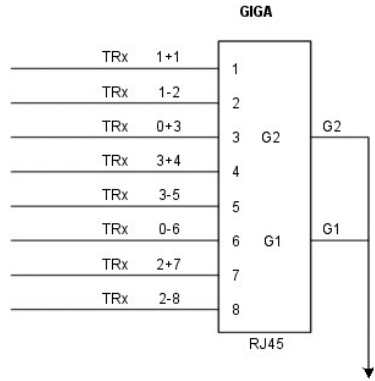

GigaPort Connector

A serial cable connects PowerConnect 3324/3348 to a terminal for the initial setup and configuration. (A PC running terminal emulation software can also be used.) The serial cable is a female-to-female DB-9 crossover cable.

The following figure illustrates the DB-9 connector.

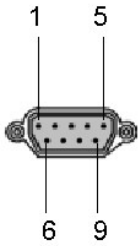

DB-9 Serial Cable

Pin	Use
1	Unused
2	TXD
3	RXD
4	Unused
5	GND
6	Unused
7	CTS
8	RTS
9	Unused

DB-9 Pin Number Allocation

Cable Connections

This section describes how to connect the various cables to the PowerConnect 3324/3348 device.

ASCII Terminal (Serial) Connection

The serial port connector is a DB-9 type connector. A supplied interface cable is required to connect the device.

To connect the device:

1. Connect the interface crossed cable to the terminal ASCII DTE RS-232 connection.
2. Connect the interface crossed cable to the device serial connection.

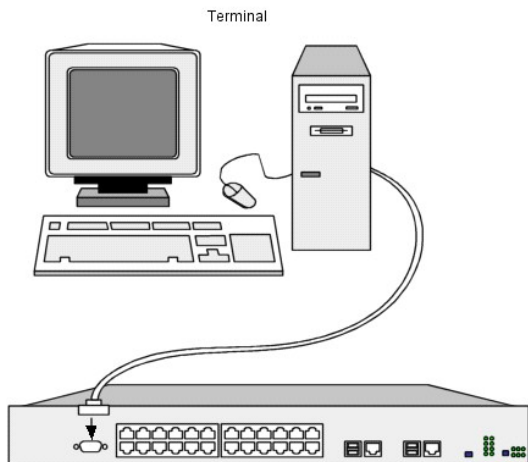

PowerConnect 3324 Terminal Connection

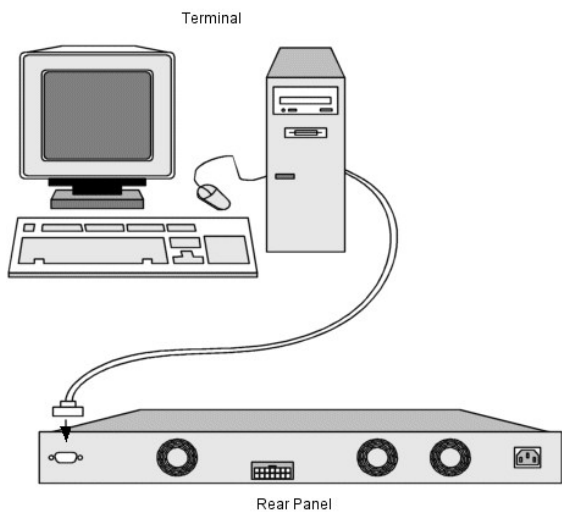

PowerConnect 3348 Terminal Connection

Overview

Dell™ PowerConnect™ 3324/3348 User's Guide

- [System Description](#)
 - [PowerConnect 3324/3348 Stacking Overview](#)
 - [PowerConnect User Guide Overview](#)
 - [PowerConnect 3324/3348 CLI Documentation](#)
-

System Description

The Dell™ PowerConnect™ 3324 and 3348 devices are standalone and stackable advanced Layer 2 switches. PowerConnect 3324 and PowerConnect 3348 also function as stand-alone Layer 2 switching systems. PowerConnect 3324/3348 devices are managed either using In-Band Management (via the network station remotely) or via the console.



PowerConnect 3324

When operating as a stack member, each PowerConnect 3324 unit provides 24 10 BaseT/100BaseTX Fast Ethernet ports, one Gigabit Ethernet Combo port (10/100/1000 BaseT or Mini GBIC connector), and one Giga Ethernet stacking port.



PowerConnect 3348

When operating as a stack member, each PowerConnect 3348 unit provides 48 10 BaseT/100BaseTX Fast Ethernet ports, one Gigabit Ethernet Combo port (10/100/1000 BaseT or Mini GBIC connector), and one Giga Ethernet stacking port.

When operating as a stand-alone unit, the PowerConnect 3324/3348 stacking ports can be used as Giga Ethernet ports.

PowerConnect 3324/3348 Stacking Overview

PowerConnect 3324/3348 stacking provides multiple device management through a single point as if all stack members are a single unit. All members are accessed through a single IP address for SNMP management and a console/telnet session through which the entire stack is managed.

PowerConnect 3324/3348 supports stacking up to six units per stack or scale up to 192 FE and six Gigabit Ethernet ports. PowerConnect 3324/3348 can also operate as standalone units.

During the stacking setup, one device is selected by the network administrator as the stack master, while all other devices are selected as stack members and assigned a unique Unit ID.

PowerConnect 3324/3348 stacks provide across-the-stack Layer 2 functionality including:

- 1 Switching

- 1 Trunking
- 1 Port Mirroring
- 1 VLANs

For example, VLANs can be configured from ports belonging to different stack members, or configure port mirroring from a second stack member to a third stack member. Applications running in a stacking configuration are centralized. For example, the Spanning Tree Protocol for the entire stack runs on the master unit. Device software is downloaded separately for each stack member.

PowerConnect 3324/3348 stacking architecture provides dynamic learning for the stacking topology, while detecting and reconfiguring the ports with minimal operational impact in the event of:

- 1 Unit Failure
- 1 Inter-unit Link Loss
- 1 Unit Insertion
- 1 Removal of a Stacking Unit

Stack Members and Unit ID

The stacking operation mode is determined during the Boot process.

PowerConnect 3324/3348 units are shipped with a default Unit ID of one. The Unit ID is essential to the stacking configuration. If a stack member reboots without a stacking module, the device operates as a stand-alone until the device is reset. If a PowerConnect 3324/3348 unit is operating as a stand-alone unit, all stacking LEDs are off. The Unit ID is not erased and remains valid if the unit is reconnected to a stack.

 **NOTE:** The stacking module must be inserted into port G2 for the stack to operate. If the stacking module is inserted in port G1, a warning message is displayed on the console.

When the master unit boots or when inserting or removing a stack member, the master unit initiates a stacking discover process. If two members are discovered with the same Unit ID, or a master unit is not found, the entire stack cannot function. The stacking LED remains red.

Configuration Handling

In a PowerConnect 3324/3348 operative stack, the stack master is responsible for the stack configuration. Each stack member does not have a separate configuration file. Each port in the stack has a specific Unit ID/port type and port number, which is part of both the configuration commands and the configuration files. Configuration files are managed only from the PowerConnect 3324/3348 stack master, including:

- 1 Saving to the FLASH.
- 1 Uploading Configuration files to an external TFTP Server.
- 1 Downloading Configuration files from an external TFTP Server.

 **NOTE:** Stack configuration for all configured ports is saved, even if the stack is reset and/or the ports are no longer present.

Configuration files are changed only through explicit user configuration. In addition, Configuration files are not automatically modified when:

- 1 Units are added.
- 1 Units are removed.
- 1 Units are reassigned Unit IDs.
- 1 Units toggle between stacking mode and stand-alone mode.

Each time the system reboots, the stored configuration is written in the Startup Configuration file.

If a PowerConnect 3324/3348 stack member is removed from the stack, and then replaced with the same Unit ID, the stack member is configured with the original device configuration.

Only ports that are physically present are displayed in the Dell OpenManage™ Switch Administrator and can be configured through the web management system. Non-present ports are configured through the CLI or SNMP interfaces.

Rearranging Stacks

The stacking order can be changed by either removing a stack member or by rearranging the stacking cables. The order in which stack members are arranged is established not by the physical order of the stack members but by the Unit ID assignment. The stack configuration is stored in stack master after the stack order is changed, and the stack is reset.

If the PowerConnect 3324/3348 unit is removed or replaced in a stack, the stack recovers from the disconnection as follows:

- 1 If the stack is disconnected for more than two minutes, the entire stack no longer forwards network traffic. Every stack member reboots and waits until the stack is reconnected. If the unit is not replaced, the master unit constantly polls the stack.
- 1 If the stack is reconnected in under two minutes, all units remain stacked and regain their connection to other units within five seconds. A new stack member is connected to the master unit but initialized according to the master unit's configuration. If a configuration is not stored, the device is configured with the default configuration.

Replacing Stack Members

If a stack member is replaced with a new device, the requested device ID is selected. In addition, the previous device configuration is applied to the inserted stack member. If the new inserted device has either more or fewer ports than the previous device, the relevant port configuration is applied to the new stack member. For example:

- 1 If a PowerConnect 3324 replaces a PowerConnect 3324, the new 24 10/100 BaseT ports receive the previous 24 10/100 BaseT port configuration. Ports G1 and G2 receive the previous device's G1 and G2 port configuration.
- 1 If a PowerConnect 3324 replaces PowerConnect 3348, then ports 1-24 10/100 BaseT receive the previous device's configuration for ports 1-24. Ports G1 and G2 receive the previous device's G1 and G2 port configuration.

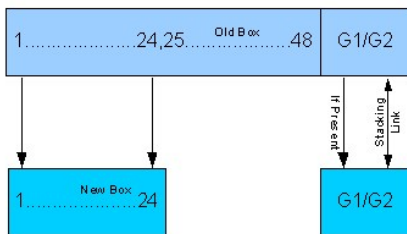

PowerConnect 3324 Replaces PowerConnect 3348

- 1 If a PowerConnect 3348 replaces PowerConnect 3348, the new 48 10/100 BaseT ports receive the previous 48 10/100 BaseT port configuration. Ports G1 and G2 receive the previous device's G1 and G2 port configuration.
- 1 If a PowerConnect 3348 replaces PowerConnect 3324, then ports 1-24 10/100 BaseT receive the previous device's configuration for ports 1-24.
- 1 Ports 25-48 receive the factory default port configuration. Ports G1 and G2 receive the previous device's G1 and G2 port configuration.

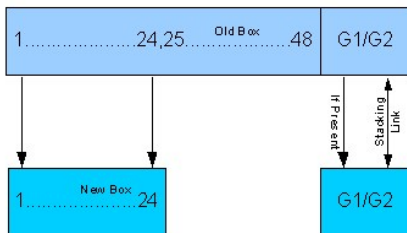

PowerConnect 3348 Replace PowerConnect 3324

PowerConnect User Guide Overview

The PowerConnect User Guide is divided into two parts:

- 1 About Installing the PowerConnect 3324/3348 Switch
- 1 Using the Dell OpenManage Switch Administrator

Installing the PowerConnect 3324/3348 Switch

This section contains the following sections about unpacking, installing, and configuring the PowerConnect 3324/3348:

- 1 [Hardware Description](#)—Contains information about the PowerConnect 3324/3348 hardware, including a description of the ports and LED types.
- 1 [Installing the PowerConnect 3324/3348 Switch](#)—Contains instructions about installing PowerConnect 3324/3348 in either a rack or on a flat surface. In addition, this section contains installation precautions, and a description of the connectors and cables.
- 1 [Configuring the PowerConnect 3324/3348 Switch](#)—Contains instructions about initial device configuration, including downloading device software, the device boot screen, and optional configuration functions.

Using the Dell OpenManage Switch Administrator

This section contains the following information about configuring the device using the web management system and Command Line Interface (CLI) device management system:

- 1 [Getting Started](#)—Contains information about getting started with the web management system interface, including an explanation of the management and information icons, the Components List, and the Device and Tree Views.
- 1 [Configuring System Information](#)—Contains information about configuring general system information including defining system information, configuring a default IP address, defining device security and SNMP communities, downloading the device software, and defining advanced settings.
- 1 [Configuring Switch Information](#)—Contains information about configuring port and VLANs, defining both static and dynamic address tables, configuring GARP and GVRP, defining Spanning Tree parameters, aggregating ports, and configuring Multicast forwarding support.
- 1 [Viewing Statistics](#)—Contains information about viewing table and chart statistics for ports, GVRP, Etherlike, RMON, and interface statistics.
- 1 [Configuring Quality of Service](#)—Contains information about configuring device Class of Service.
- 1 [Getting Help](#)—Contains information about technical assistance, problems with your order, returning items for repair or credit, and how to contact Dell.

PowerConnect 3324/3348 CLI Documentation

In addition to the *PowerConnect 3324/3348 User Guide*, Dell provides the *PowerConnect 3324/3348 CLI Reference Guide*. The *PowerConnect 3324/3348 CLI Reference Guide* provides information about the CLI commands used to configure the PowerConnect 3324/3348.

[Back to Contents Page](#)

[Back to Contents Page](#)

Viewing Statistics

Dell™ PowerConnect™ 3324/3348 User's Guide

- [Viewing Tables](#)
- [Viewing RMON Information](#)
- [Viewing Charts](#)

The Statistics pages contains device information for interface, GVRP, etherlike, RMON, and device utilization. To open the **Statistics/RMON** page:

- 1 Click **Statistics/RMON** in the Tree View. The **Statistics/RMON** page opens.

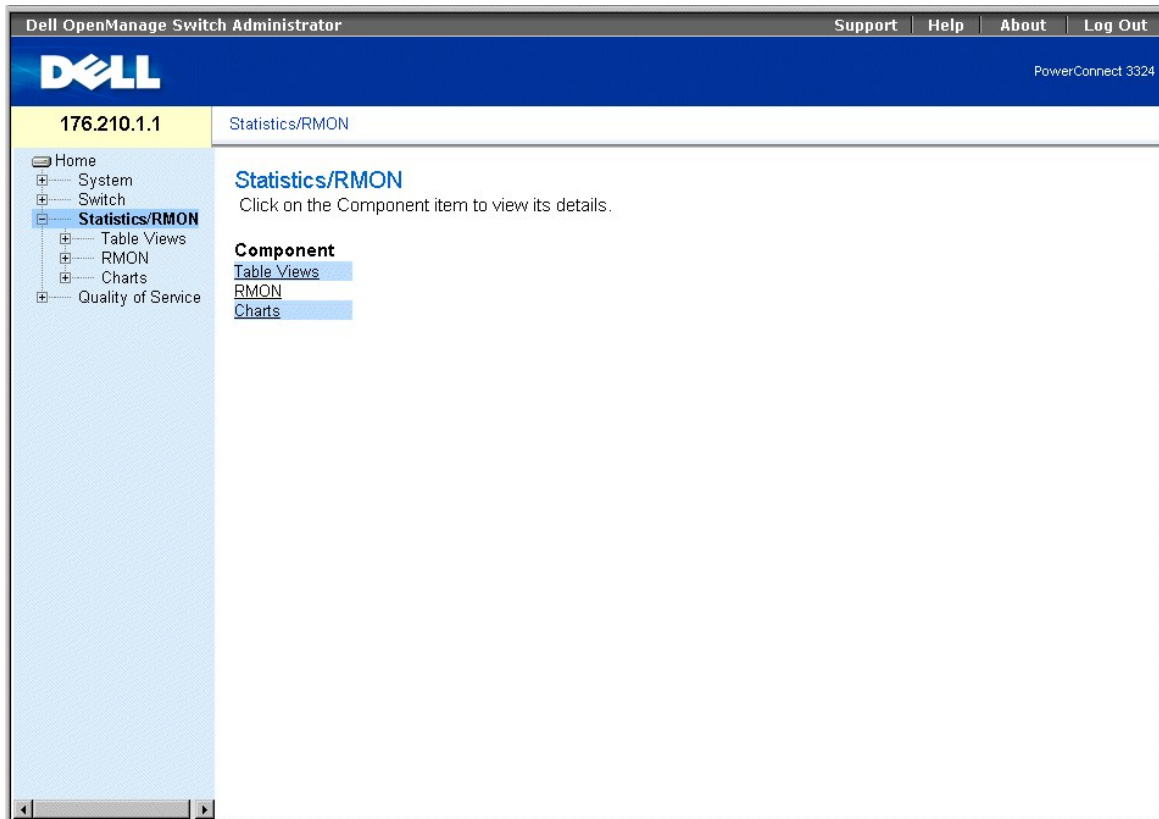

Statistic/RMON Page

This section contains the following topics:

- 1 [Viewing Tables](#)
- 1 [Viewing RMON Information](#)
- 1 [Viewing Charts](#)

Viewing Tables

The **Table View** page contains links for displaying statistics in a table form. To open the **Table View** page:

- 1 Click **Statistics > Table** in the Tree View. The **Table View** page opens.

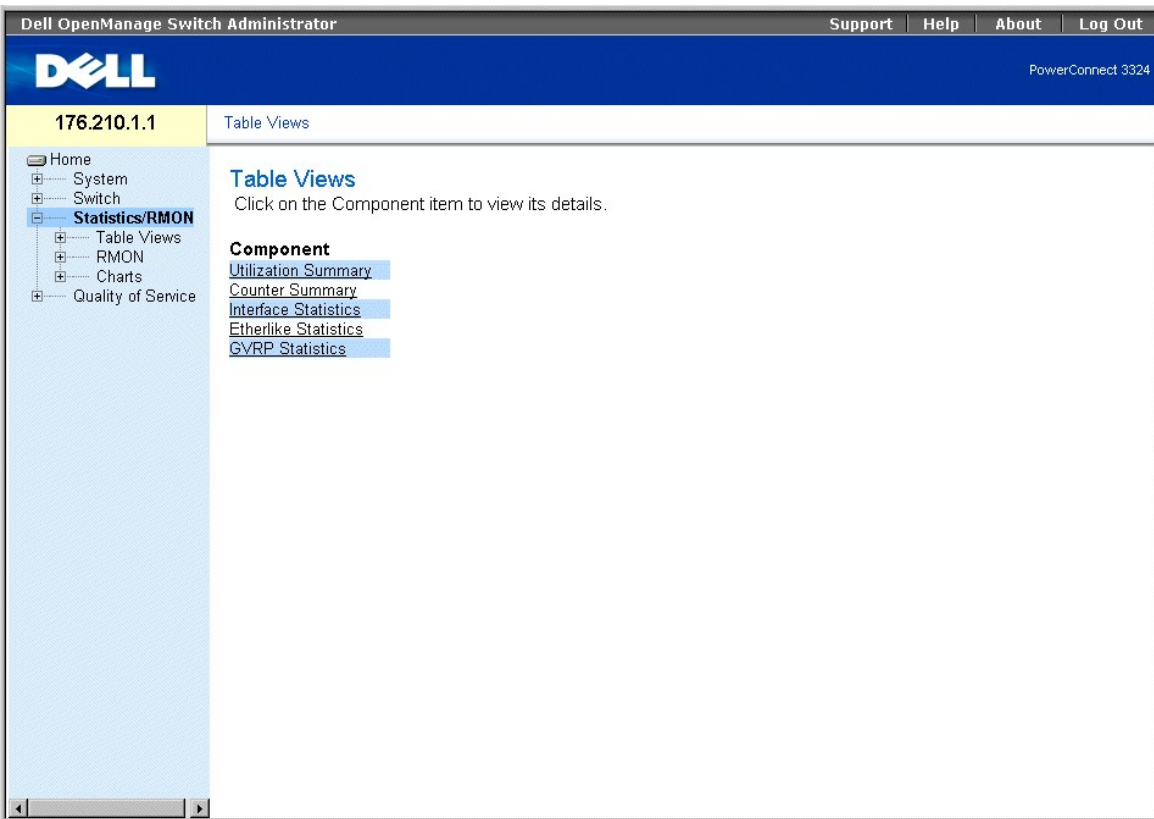

Table View Page

The **Table View** page contains the following links:

- 1 [Viewing Utilization Summary](#)
- 1 [Viewing Counter Summary](#)
- 1 [Viewing Interface Statistics](#)
- 1 [Viewing Etherlike Statistics](#)
- 1 [Viewing GVRP Statistics](#)

Viewing Utilization Summary

The **Utilization Summary** page contains statistics for port utilization. To open the **Utilization Summary** page:

- 1 Click **Statistics > Table View > Utilization Summary** in the Tree View. The **Utilization Summary** page opens:

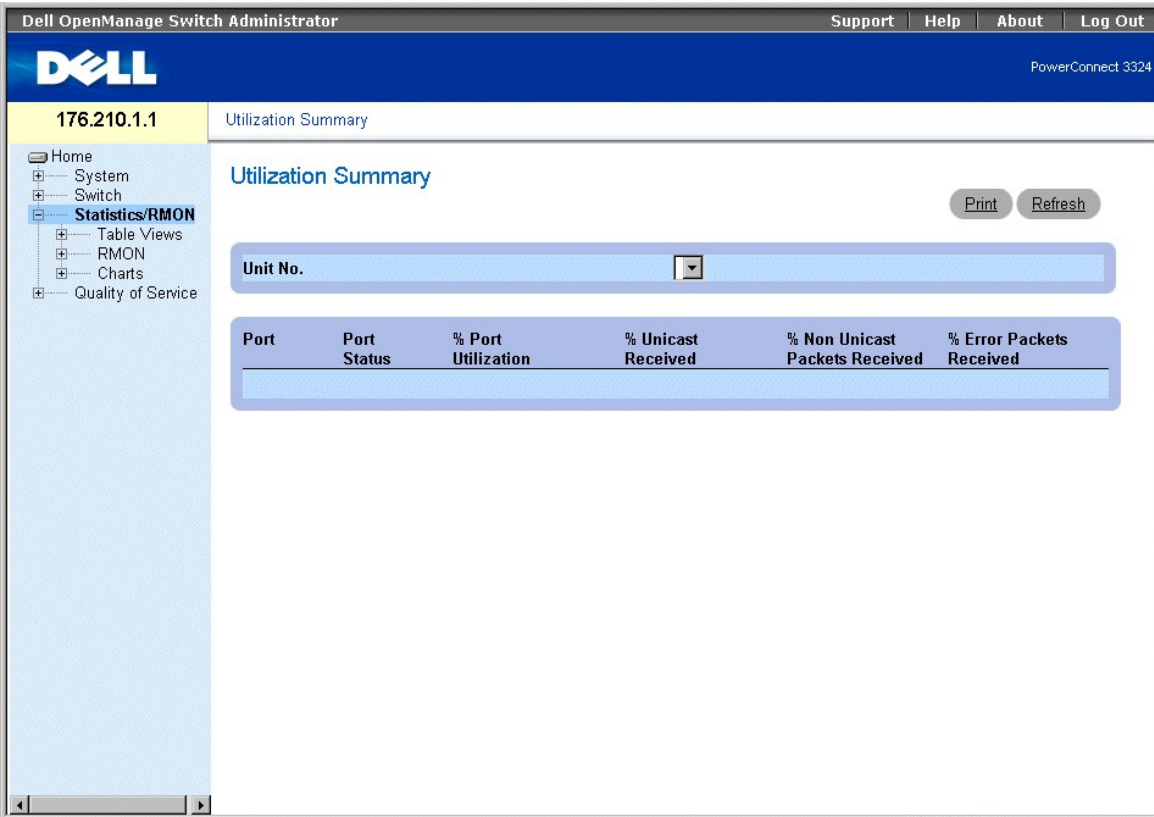

Utilization Summary Page

The **Utilization Summary** page contains the following fields:

- 1 **Unit No.**—Indicates the unit number for which port statistics are displayed.
- 1 **Port**—Indicates the port number.
- 1 **Port Status**—Indicates the port status.
- 1 **% Port Utilization**—Indicates the port utilization.
- 1 **% Unicast Received**—Indicates the percentage of Unicast packets received on the ports.
- 1 **% Non Unicast Received**—Indicates the number of bad packets received on the port
- 1 **% Error Packets Received**—Indicates the number packets with errors received on the port.

Viewing utilization statistics:

1. Open the **Utilization Summary** page.
2. Select a unit in the **Unit** field. The utilization statistics display for the selected unit.

Viewing Counter Summary

The **Counter Summary** page contains statistics for port utilization in numeric sums as opposed to percentages. To open the **Counter Summary** page:

- 1 Click **Statistics/RMON > Table Views > Counter Summary** in the Tree View. The **Counter Summary** page opens:

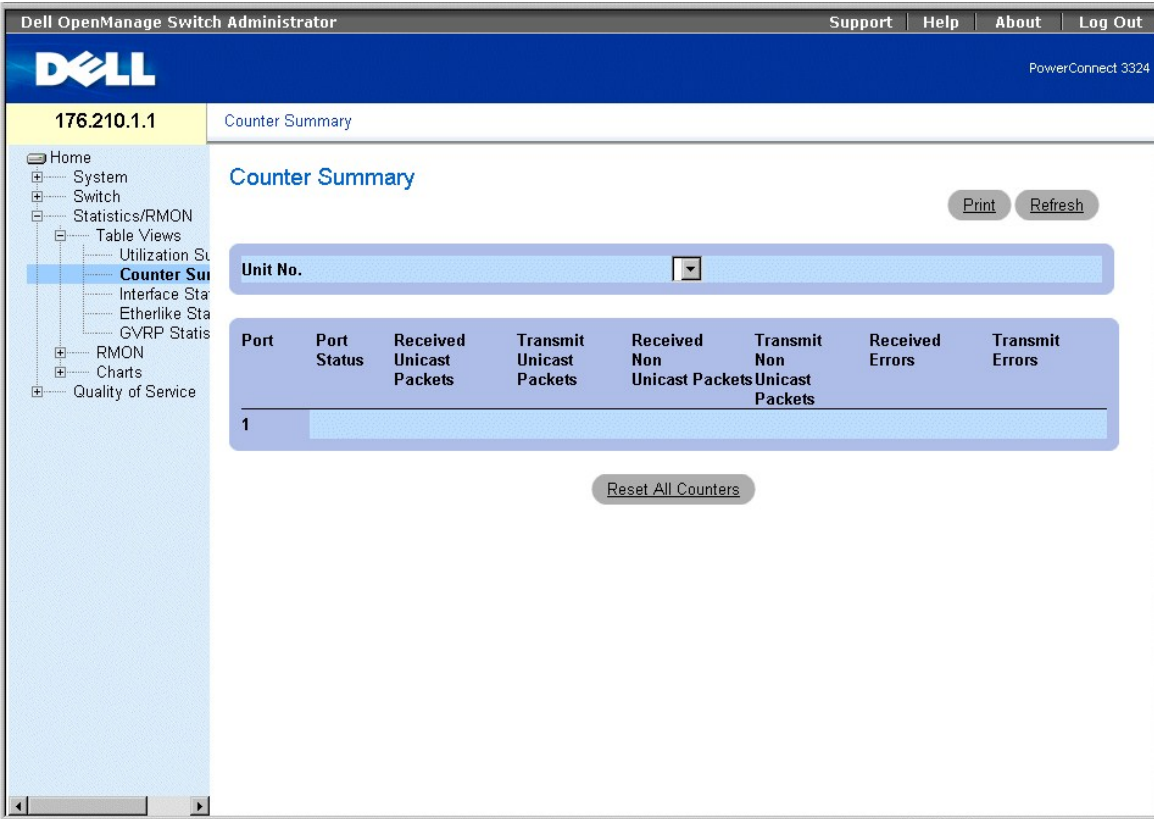

Counter Summary Page

The **Counter Summary** page contains the following fields:

- 1 **Unit No.**—Indicates the unit number for which port statistics are displayed.
- 1 **Port**—Indicates the port number.
- 1 **Port Status**—Indicates the port status.
- 1 **Received Unicast Packets**—Indicates the number of received Unicast packets on the port.
- 1 **Transmit Unicast Packets**—Indicates the number of transmitted Unicast packets from the port.
- 1 **Received Non-Unicast Packets**—Indicate the number of received non-Unicast packets on the port.
- 1 **Transmit Non-Unicast Packets**—Indicates the number of transmitted non-Unicast packets from the port.
- 1 **Received Errors**—Indicates the number of received errors on the port.
- 1 **Transmit Errors**—Indicates the number of transmitted errors from the port.

Viewing counter summary statistics:

- 1. Open the **Counter Summary** page.
- 2. Select a unit in the **Unit** field. The counter summary statistics display for the selected unit.

Viewing Interface Statistics

The **Interface Statistics** page contains interface statistics. To open the **Interface Statistics** page:

- 1 Click **Statistics/RMON > Table Views > Interface Statistics** in the Tree View. The **Interface Statistics** page opens.

The screenshot shows the Dell OpenManage Switch Administrator web interface. At the top, there is a navigation bar with 'Support', 'Help', 'About', and 'Log Out' links. Below this is a blue header with the Dell logo and the IP address '176.210.1.1'. The main content area is titled 'Interface Statistics' and includes a 'Print' and 'Refresh' button. A control panel allows selecting the interface type (Port or LAG) and the refresh rate (No Refresh). The statistics are divided into 'Receive Statistics' and 'Transmit Statistics', each with fields for Total Bytes (Octets), Unicast Packets, Multicast Packets, Broadcast Packets, Unknown Packets, Discarded Packets, and Packets with Errors.

Interface Statistics Page

The **Interface Statistics** page contains the following fields:

- 1 **Interface**—Specifies the interface (type and number) for which the statistics are displayed.
 - o **Port**—Indicates port statistics are displayed.
 - o **LAG**—Indicates LAG statistics are displayed.
- 1 **Refresh Rate**—Indicates the amount of time that passes before the interface statistics are refreshed. The possible field values are:
 - o **15 Sec**—Indicates that the interface statistics are refreshed every 15 seconds.
 - o **30 Sec**—Indicates that the interface statistics are refreshed every 30 seconds.
 - o **60 Sec**—Indicates that the interface statistics are refreshed every 60 seconds.
 - o **No Refresh**—Indicates that the interface statistics are not automatically refreshed.
- 1 **Total Bytes (Octets) Received**—Displays the amount of bytes received on the selected interface.
- 1 **Received Unicast Packets**—Displays the amount of Unicast packets received on the selected interface.
- 1 **Received Multicast Packets**—Displays the amount of Multicast packets received on the selected interface.
- 1 **Received Broadcast Packets**—Displays the amount of Broadcast packets received on the selected interface.
- 1 **Received Unknown Packets**—Displays the amount of unknown packets received on the selected interface.
- 1 **Received Discarded Packets**—Displays the amount of discarded packets on the selected interface during receive.
- 1 **Received Packets with Errors**—Displays the amount of packets with errors received on the selected interface.
- 1 **Total Bytes (Octets) Transmitted**—Displays the amount of bytes transmitted from the selected interface.
- 1 **Transmitted Unicast Packets**—Displays the amount of Unicast packets transmitted from the selected interface.
- 1 **Transmitted Multicast Packets**—Displays the amount of Multicast packets transmitted from the selected interface.
- 1 **Transmitted Broadcast Packets**—Displays the amount of Broadcast packets transmitted from the selected interface.
- 1 **Transmitted Unknown Packets**—Displays the amount of unknown packets transmitted from the selected interface.
- 1 **Transmitted Discarded Packets**—Displays the amount of discarded packets from the selected interface during transmission.
- 1 **Transmitted Packets with Errors**—Displays the amount of packets found to have errors during transmission from the selected interface.

Displaying interface statistics for a port:

1. Open the **Interface Statistics** page.
2. Select **Port** in the **Interface** field.
3. Click **Reset All Counters**. The port interface statistics are displayed.

Displaying interface statistics for a LAG:

1. Open the **Interface Statistics** page.
2. Select **LAG** in the **Interface** field.
3. Click **Reset All Counters**. The LAG interface statistics are displayed.

Viewing Interface Statistics Using the CLI Commands

This section contains the CLI commands for viewing interface statistics.

CLI Command	Description
<code>show interfaces counters [ethernet interface port-channel port-channel-number]</code>	Displays traffic seen by a physical interface.

The following is an example of the CLI commands:

```
console# show interfaces counters ethernet 1/e1

Port InOctets InUcastPkts InMcastPkts InBcastPkts

-----

1/e1 1717 0 326 26

Port OutOctets OutUcastPkts OutMcastPkts OutBcastPkts

-----

1/e1 21845 0 326 26

Alignment Errors: 0

FCS Errors: 0

Single Collision Frames: 0
```

Multiple Collision Frames: 0

Deferred Transmissions: 0

Late Collisions: 0

Excessive Collisions: 0

Internal MAC Tx Errors: 0

Carrier Sense Errors: 0

Oversize Packets: 0

Internal MAC Rx Errors: 0

Symbol Errors: 0

Received Pause Frames: 0

Transmitted Pause Frames: 0

Viewing Etherlike Statistics

The **Etherlike Statistics** page contains interface statistics. To open the **Etherlike Statistics** page:

- 1 Click **Statistics/RMON** > **Table Views** > **Etherlike Statistics** in the Tree View. The **Etherlike Statistics** page opens.

The screenshot shows the Dell OpenManage Switch Administrator interface. The top navigation bar includes 'Support', 'Help', 'About', and 'Log Out'. The main header displays the Dell logo and 'PowerConnect 3324'. The left sidebar shows a navigation tree with 'Etherlike St' selected. The main content area is titled 'Etherlike Statistics' and contains a form with 'Interface' (Port/LAG dropdowns) and 'Refresh Rate' (No Refresh dropdown). Below the form is a list of error categories: Alignment Errors, Frame Check Sequence (FCS) Errors, Single Collision Frames, Multiple Collision Frames, Deferred Transmissions, Late Collisions, Excessive Collisions, Internal MAC Transmit Errors, Carrier Sense Errors, Oversize Packets, Internal MAC Receive Errors, Symbol Errors, Received Pause Frames, and Transmitted Paused Frames.

Etherlike Statistics Page

The **Etherlike Statistics** page contains the following fields:

- 1 **Interface**—Specifies the interface type for which the statistics are displayed.
 - o **Port**—Indicates port statistics are displayed.
 - o **LAG**—Indicates LAG statistics are displayed.
- 1 **Refresh Rate**—Indicates the amount of time that passes before the interface statistics are refreshed. The possible field values are:
 - o **15 Sec**—Indicates that the Etherlike statistics are refreshed every 15 seconds.
 - o **30 Sec**—Indicates that the Etherlike statistics are refreshed every 30 seconds.
 - o **60 Sec**—Indicates that the Etherlike statistics are refreshed every 60 seconds.
 - o **No Refresh**—Indicates that the Etherlike statistics are not automatically refreshed.
- 1 **Alignment Errors**—Displays the amount of alignment errors received on the selected interface.
- 1 **Frame Check Sequence (FCS) Errors**—Displays the amount of Frame Check Sequence errors received on the selected interface.
- 1 **Single Collision Frames**—Displays the amount of Single Collisions Frames errors received on the selected interface.
- 1 **Multiple Collision Frames**—Displays the amount of Multiple Collisions Frames errors received on the selected interface.
- 1 **Deferred Transmissions**—Displays the amount of deferred transmissions on the selected interface.
- 1 **Late Collision**—Displays the amount of late collisions received on the selected interface.
- 1 **Excessive Collisions**—Displays the amount of excessive collisions received on the selected interface.
- 1 **Internal MAC Transmit Errors**—Displays the amount of Internal MAC Transmit errors on the selected interface.
- 1 **Carrier Sense Errors**—Displays the amount of Carrier Sense errors on the selected interface.
- 1 **Oversize Packets**—Displays the amount of frame errors that are too long on the selected interface.
- 1 **Internal MAC Receive Errors**—Displays the amount of Internal MAC Received errors on the selected interface.
- 1 **Symbol Errors**—Displays the amount of Symbol errors on the selected interface.
- 1 **Receive Pause Frames**—Displays the amount of Received Pause frames on the selected interface (IEEE 802.3X).
- 1 **Transmitted Paused Frames**—Displays the amount of Transmitted Pause frames on the selected interface (IEEE 802.3X).

Displaying Etherlike statistics for a port:

1. Open the **Etherlike Statistics** page.
2. Select **Port** in the **Interface** field.
3. Click **Query**. The port Etherlike statistics are displayed.

Displaying Etherlike statistics for a LAG:

1. Open the **Etherlike Statistics** page.
2. Select **LAG** in the **Interface** field.
3. Click **Query**. The LAG Etherlike statistics are displayed.

Viewing GVRP Statistics

The **GVRP Statistics** page contains device statistics for GVRP. To open the **GVRP Statistics** page:

1. Click **Statistics/RMON > Table Views > GVRP Statistics** in the Tree View. The **GVRP Statistics** page opens:

Dell OpenManage Switch Administrator Support Help About Log Out

PowerConnect 3324

176.210.1.1 GVRP Statistics

GVRP Statistics Print Refresh

Interface Port LAG

Refresh Rate No Refresh

GVRP Statistics Table	Received	Transmitted
Join Empty		
Empty		
Leave Empty		
Join In		
Leave In		
Leave All		

GVRP Error Statistics
Invalid Protocol ID
Invalid Attribute Type
Invalid Attribute Value
Invalid PDU Length
Invalid Attribute Length

GVRP Statistics Page

The **GVRP Statistics** page contains the following fields:

1. **Interface**—Specifies the interface type for which the statistics are displayed.
 - o **Port**—Indicates port statistics are displayed.
 - o **LAG**—Indicates LAG statistics are displayed.
1. **Refresh Rate**—Indicates the amount of time that passes before the GVRP statistics are refreshed. The possible field values are:

- o **15 Sec**—Indicates that the GVRP statistics are refreshed every 15 seconds.
 - o **30 Sec**—Indicates that the GVRP statistics are refreshed every 30 seconds.
 - o **60 Sec**—Indicates that the GVRP statistics are refreshed every 60 seconds.
 - o **No Refresh**—Indicates that the GVRP statistics are not automatically refreshed.
- 1 **Join Empty**—Displays the device GVRP Join Empty statistics.
 - 1 **Empty**—Displays the device GVRP Empty statistics.
 - 1 **Leave Empty**—Displays the device GVRP Leave statistics.
 - 1 **Join In**—Displays the device GVRP Join In statistics.
 - 1 **Leave In**—Displays the device GVRP Leave in statistics.
 - 1 **Invalid Protocol ID**—Displays the device GVRP Invalid Protocol ID statistics.
 - 1 **Invalid Attribute Type**—Displays the device GVRP Invalid Attribute ID statistics.
 - 1 **Invalid Attribute Value**—Displays the device GVRP Invalid Attribute Value statistics.
 - 1 **Invalid PDU Length**—Displays the device GVRP Invalid PDU length statistics.
 - 1 **Invalid Attribute Length**—Displays the device GVRP Invalid Attribute Length statistics.
 - 1 **Invalid Events**—Displays the device GVRP Invalid Events statistics.

Displaying GVRP statistics for a port:

1. Open the **GVRP Statistics** page.
2. Select **Port** in the **Interface** field.
3. Click **Query**. The port GVRP statistics are displayed.

Displaying GVRP statistics for a LAG:

1. Open the **GVRP Statistics** page.
2. Select **LAG** in the **Interface** field.
3. Click **Query**. The LAG GVRP statistics are displayed.

Viewing GVRP Statistics Using the CLI Commands

For information about viewing the GVRP instructions on a per-port basis, see the **Port Statistics** page. The following table describes the CLI commands.

CLI Command	Description
<code>show gvrp statistics [ethernet <i>interface</i> port-channel <i>port-channel- number</i>]</code>	Displays GVRP statistics.
<code>show gvrp error-statistics [ethernet <i>interface</i> port-channel <i>port-channel-number</i>]</code>	Displays GVRP error statistics.

The following is an example of the CLI commands:

```
Console# show gvrp statistics
```

```
GVRP statistics:
```

```
-----
```

Legend:

rJE: Join Empty Received . : Join In Received

rEmp : Empty Received rLIn : Leave In Received

rLE : Leave Empty Received rLA : Leave All Received

sJE : Join Empty Sent sJIn : Join In Sent

sEmp : Empty Sent sLIn : Leave In Sent

sLE : Leave Empty Sent sLA : Leave All Sent

Port rJE rJIn rEmp rLIn rLE rLA sJE sJIn sEmp sLIn sLE sLA

----- 1/e1 0 0 0 0 0 0 0 0 0 0 0 0

1/e2 0 0 0 0 0 0 0 0 0 0 0 0

1/e3 0 0 0 0 0 0 0 0 0 0 0 0

1/e4 0 0 0 0 0 0 0 0 0 0 0 0

1/e5 0 0 0 0 0 0 0 0 0 0 0 0

1/e6 0 0 0 0 0 0 0 0 0 0 0 0

1/e7 0 0 0 0 0 0 0 0 0 0 0 0

1/e8 0 0 0 0 0 0 0 0 0 0 0 0

Viewing RMON Information

Remote Monitoring (RMON) allows network managers to view network traffic information from a remote location. To open the **RMON** page:

- 1 Click **Statistics/RMON > RMON** in the Tree View. The **RMON** page opens.

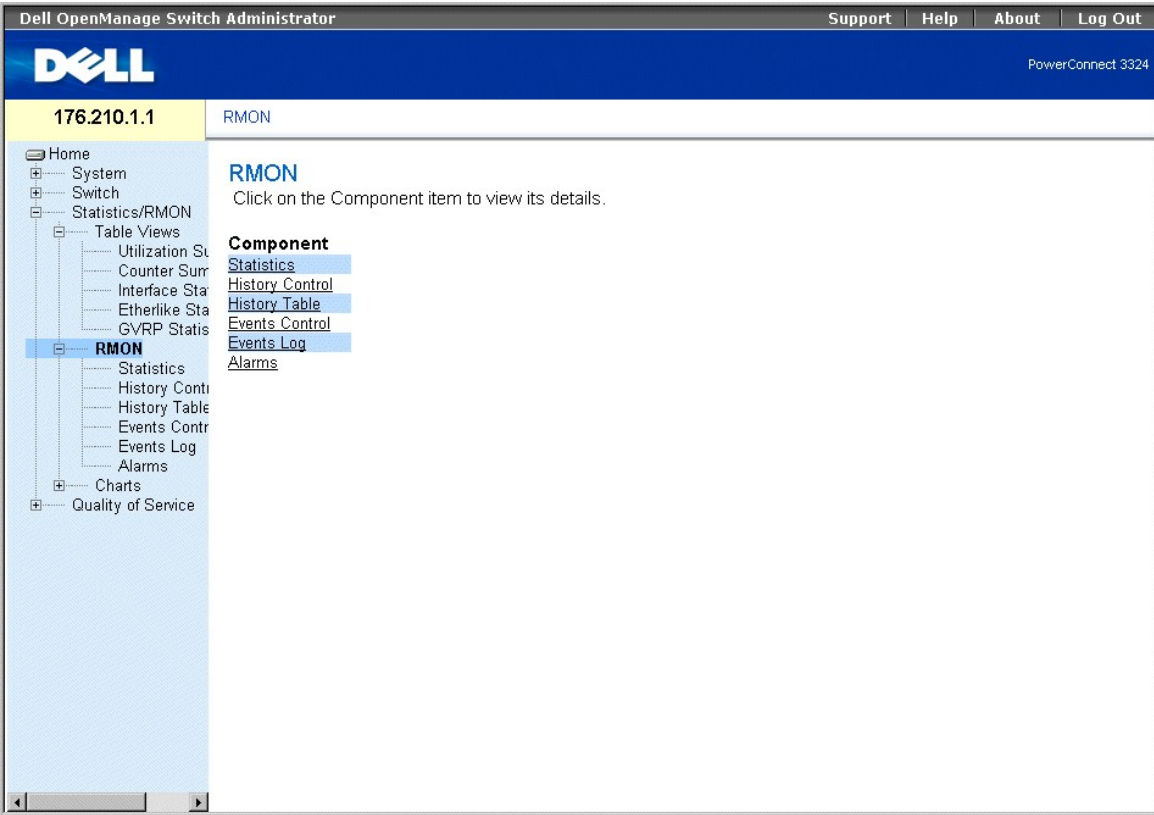

RMON Page

This section contains the following topics:

- 1 [Viewing RMON Statistics](#)
- 1 [Viewing History Control Statistics](#)
- 1 [Viewing The RMON History Table](#)
- 1 [Defining Device Events](#)
- 1 [Viewing the Events Log](#)
- 1 [Defining Device Alarms](#)

Viewing RMON Statistics

The **RMON Statistics Group** page allows network managers to display RMON statistics for an interface. Interface statistics provide information about device utilization, and errors that occurred on the device. To open the **RMON Statistics Group** page:

- 1 Click **Statistics/RMON > RMON > Statistics** in the Tree View. The **RMON Statistics Group** page opens.

Dell OpenManage Switch Administrator Support Help About Log Out

PowerConnect 3324

176.210.1.1 RMON Statistics Group

- Home
- System
- Switch
- Statistics/RMON
 - Table Views
 - Utilization St
 - Counter Surr
 - Interface Sta
 - Etherlike Sta
 - GVRP Statis
 - RMON
 - Statistics**
 - History Cont
 - History Table
 - Events Contr
 - Events Log
 - Alarms
 - Charts
 - Quality of Service

RMON Statistics Group

Interface Port LAG

Refresh Rate No Refresh

Drop Events

Received Bytes (Octets)

Received Packets

Broadcast Packets Received

Multicast Packets Received

CRC& Align Errors

Undersize Packets

Oversize Packets

Fragments

Jabbers

Collisions

RMON Statistics Group Page

The **RMON Statistics Group** page contains the following information:

- 1 **Interface**—Indicates the interface type and number for which statistics are displayed. The possible field values are:
 - o **Port**—Indicates that port specific statistics are displayed.
 - o **LAG**—Indicates that LAG specific statistics are displayed.
- 1 **Refresh Rate**—Indicates the amount of time that passes before the RMON statistics are refreshed. The possible field values are:
 - o **15 Sec**—Indicates that the RMON statistics are refreshed every 15 seconds.
 - o **30 Sec**—Indicates that the RMON statistics are refreshed every 30 seconds.
 - o **60 Sec**—Indicates that the RMON statistics are refreshed every 60 seconds.
 - o **No Refresh**—Indicates that the RMON statistics are not automatically refreshed.
- 1 **Drop Events**—Indicates the amount of dropped events that have occurred on the interface since the counters were last cleared.
- 1 **Received Octets**—Indicates the amount of octets received on the interface since the counters were last cleared.
- 1 **Received Packets**—Indicates the amount of packets received on the interface since the counters were last cleared.
- 1 **Broadcast Packets Received**—Indicates the amount of Broadcast packets received on the interface since the counters were last cleared.
- 1 **Multicast Packets Received**—Indicates the amount of Multicast packets received on the interface since the counters were last cleared.
- 1 **CRC& Align Errors**—Indicates the amount of CRC and Align errors that have occurred on the interface since the counters were last cleared.
- 1 **Undersize Packets**—Indicates the amount of undersized packets received on the interface since the counters were last cleared.
- 1 **Oversize Packets**—Indicates the amount of oversized packets received on the interface since the counters were last cleared.
- 1 **Fragments**—Indicates the amount of fragments received on the interface since the counters were last cleared.
- 1 **Jabbers**—Indicates the amount of jabbers received on the interface since the counters were last cleared.
- 1 **Collisions**—Indicates the amount of collisions received on the interface since the counters were last cleared.
- 1 **Frames of 64 Bytes**—Indicates the amount of 64 byte packets received on the interface since the counters were last cleared.
- 1 **Frames of 65-127 Bytes**—Indicates the amount of 65-127 byte packets received on the interface since the counters were last cleared.
- 1 **Frames of 128-255 Bytes**—Indicates the amount of 128-255 byte packets received on the interface since the counters were last cleared.

- 1 **Frames of 256-511 Bytes**—Indicates the amount of 256-511 byte packets received on the interface since the counters were last cleared.
- 1 **Frames of 512-1023 Bytes**—Indicates the amount of 512-1023 byte packets received on the interface since the counters were last cleared.
- 1 **Frames of 1024-1518 Bytes**—Indicates the amount of 1024-1518 byte packets received on the interface since the counters were last cleared.

Viewing interface statistics:

1. Open the **RMON Statistics Group** page.
2. Select an interface type and number in the **Interface** field. The interface statistics display in the **RMON Statistics** section.

Viewing RMON Statistics Using the CLI Commands

The following table summarizes the equivalent CLI commands for viewing fields displayed in the **RMON Statistics Group** page.

CLI Command	Description
<code>show rmon statistics [ethernet <i>interface</i> port-channel <i>port-channel-number</i>]</code>	Displays RMON ethernet Statistics.

The following is an example of the CLI command:

```

Console# show rmon statistics ethernet 1/e1

Port 1/e1

Dropped: 8

Octets: 878128 Packets: 978

Broadcast: 7 Multicast: 1

CRC Align Errors: 0 Collisions: 0

Undersize Pkts: 0 Oversize Pkts: 0

Fragments: 0 Jabbers: 0

64 Octets: 98 65 to 127 Octets: 0

128 to 255 Octets: 0 256 to 511 Octets: 0

512 to 1023 Octets: 491 1024 to 1518 Octets: 389

```

Viewing History Control Statistics

The **RMON History Control** page contains information about samples of RMON data taken from ports. The **RMON History Control** page controls the collection of these samples.

- 1 Click **Statistics/RMON > History Control** in the Tree View. The **RMON History Control** page opens.

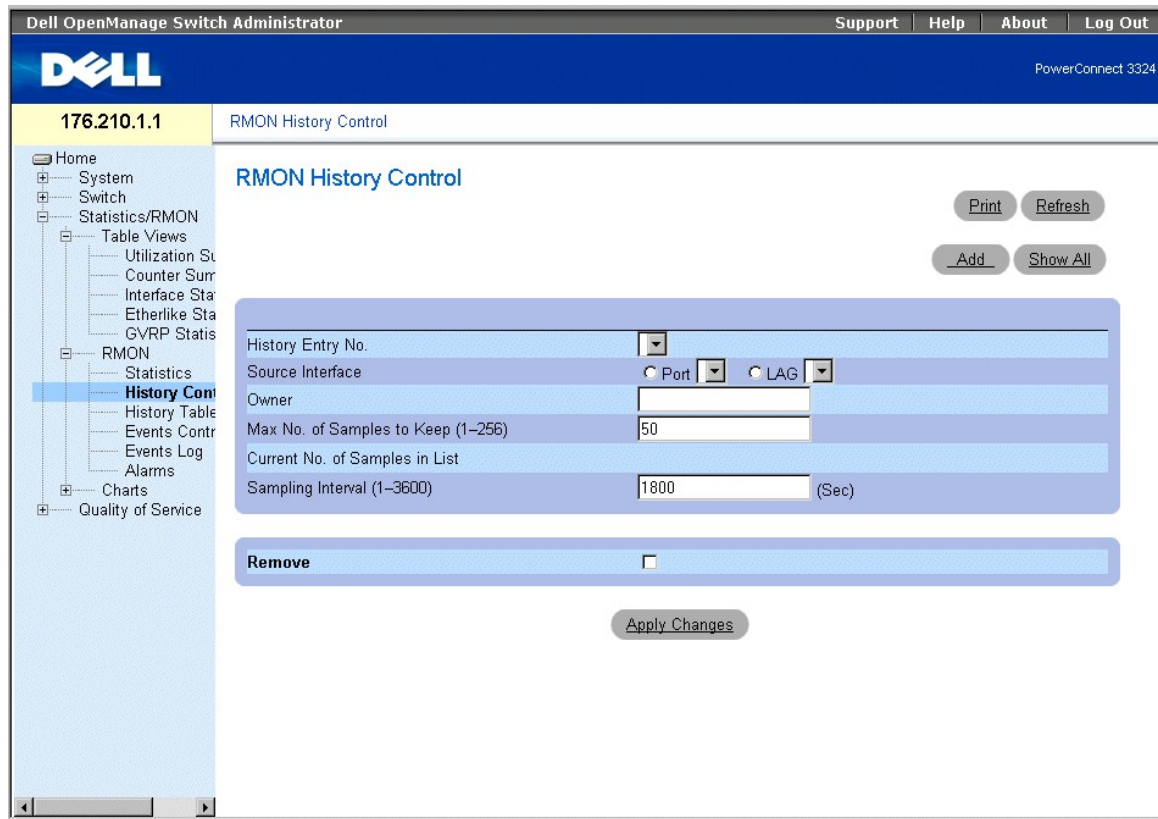

RMON History Control Page

The **RMON History Control** page contains the following information:

- 1 **History Entry No.**—Specifies the **History Control Table** entry.
- 1 **Source Interface**—Indicates the source from which the history samples were taken. The possible field values are:
 - o **Port**—Indicates the history samples were taken from a port.
 - o **LAG**—Indicates the history samples were taken from a LAG.
- 1 **Owner**—Indicates the RMON station or user that requested the RMON information.
- 1 **Max Number of Samples to Keep**—Indicates the number of samples to be saved. The default value is **50**.
- 1 **Current Number of Samples**—Indicates the current number of samples taken.
- 1 **Sampling Interval**—Indicates in seconds the time that samplings are taken from the ports. The possible values are 1-3600 seconds. The default is **1800** seconds (30 minutes).
- 1 **Remove**—Removes the **History Control Table** entry.
 - o **Checked**—Removes the **History Control Table** entry.
 - o **Unchecked**—Maintains the **History Control Table** entry.

Adding a History Control Entry:

1. Open the **RMON History Control** page.
2. Click **Add**. The **Add History Entry** page opens

Add History Entry

Attribute	Value
History Entry No.	<input type="text"/>
Source Interface	<input type="radio"/> Port <input type="text" value="E1"/> <input type="radio"/> Trunk <input type="text" value="R&D"/>
Owner	<input type="text"/>
Max No. of Samples to Keep	<input type="text"/>
Sampling Interval	<input type="text"/>

Add History Entry

3. Define the **History Entry No.**, **Source Interface**, **Owner**, **Max No. of Samples to Keep**, and the **Sampling Interval** fields.
4. Click **Apply Changes**. The **History Control Entry** is added.

Modifying a History Control Table entry:

1. Open the **RMON History Control** page.
2. Select an **RMON History Control Table** entry in the **History Index** field.
3. Modify the **Source Interface**, **Owner**, **Max Number of Samples to Keep**, **Number of Current Samples**, and/or the **Sampling Interval** fields.
4. Click **Apply Changes**. The **RMON History Control Table** entry is modified, and the device is updated.

Displaying the History Control Table:

1. Open the **RMON History Control** page.
2. Click **Show All**. The **History Control Table** opens.

RMON History Control Table

History Entry No.	Source Interface	Sampling Interval	Samples Requested	Current Samples	Owner	Remove
1	<input type="text"/>	<input type="text"/>	<input type="text"/>	<input type="text"/>	<input type="text"/>	<input type="checkbox"/>

History Control Table

Deleting a History Control Table entry:

1. Open the **RMON History Control** page.
2. Select a **History Control Table** entry in the **History Index** field.
3. Check the **Remove** check box.
4. Click **Apply Changes**. The **RMON History Control Table** entry is deleted, and the device is updated.

Viewing The RMON History Table

The **RMON History Table** contains interface-specific RMON statistical network samplings. Each table entry represents all counter values compiled during a single sample. To open the **RMON History Table**:

1. Click **Statistics/RMON > RMON History > History Table** in the Tree View.

Dell OpenManage Switch Administrator Support Help About Log Out

PowerConnect 3324

176.210.1.1 RMON History Table

- Home
- System
- Switch
- Statistics/RMON
 - Table Views
 - Utilization St
 - Counter Surr
 - Interface Sta
 - Etherlike Sta
 - GVRP Statis
 - RMON
 - Statistics
 - History Cont
 - History Tabl**
 - Events Contr
 - Events Log
 - Alarms
- Charts
- Quality of Service

RMON History Table

Print Refresh

History Entry No. ▼
Owner

Sample No.	Drop Events	Received Bytes (Octets)	Received Packets	Broadcast Packets	Multicast Packets	CRC Align Errors	Undersize Packets	Oversize Packets	Fragments	Jabbers	Collisions	Utiliz

Apply Changes

RMON History Table

NOTE: Not all fields are shown in the RMON History Table.

The **RMON History Table** contains the following fields:

- 1 **Sample No.**—Indicates the specific sample that the information in the table reflects.
- 1 **Drop Events**—Indicates the number of dropped packets due to lack of network resources during the sampling interval. This may not represent the exact number of dropped packets, but rather the number of times dropped packets were detected.
- 1 **Received Bytes (Octets)**—Indicates the number of data octets, including bad packets, received on the network.
- 1 **Received Packets**—Indicates the number of packets received during the sampling interval.
- 1 **Broadcast Packets**—Indicates the number of good broadcast packets received during the sampling interval.
- 1 **Multicast Packets**—Indicates the number of good multicast packets received during the sampling interval.
- 1 **CRC Align Errors**—Indicates the number of packets received during the sampling session with a length 64-1518 octets that have a bad Frame Check Sequence (FCS) with an integral number of octets or a bad FCS with a non-integral number.
- 1 **Undersized Packets**—Indicates the number of packets received that are less than 64 octets long during the sampling session.
- 1 **Oversized Packets**—Indicates the number of packets received that are more than 1518 octets long during the sampling session.
- 1 **Fragments**—Indicates the number of packets received that are less than 64 octets long and have a FCS during the sampling session.
- 1 **Jabbers**—Indicates the number of packets received that are more than 1518 octets long and had a FCS during the sampling session.
- 1 **Collisions**—Estimates the total number of packet collisions that occurred during the sampling session. Collisions are detected when repeater ports detect two or more stations transmitting simultaneously.
- 1 **Utilization**—Estimates the main physical layer network Description on an interface during the session sampling. The value is reflected in percentages with two decimal places.

Viewing statistics for a specific history entry:

1. Open the **RMON History Table** page.
2. Select a history entry in the **History Table No.** field. The entry statistics display in the **RMON History Table**.

Viewing RMON History Statistics Using the CLI Commands

The following table contains the CLI commands for viewing RMON history statistics.

CLI Command	Description
rmon table-size history <i>entries</i>	Configures the maximum number of history table entries.
rmon collection history <i>index</i> [OWNER <i>ownername</i>] [buckets <i>bucket-number</i>] [interval <i>seconds</i>]	Enables a Remote Monitoring (RMON) MIB history statistics group on an interface.
show rmon history <i>index</i> { throughput errors other } [period <i>hh:mm:ss</i>]	Displays RMON ethernet Statistics history.

The following is an example of the CLI commands:

```
Console (config)# rmon table-size history 1000
```

```
Console (config)# interface ethernet 1/e8
```

```
Console (config-if)# rmon collection history 1 interval 2400
```

```
Console# show rmon history 1 throughput
```

```
Sample set: 1 Owner: CLI
```

```
Interface: 1/e1 Interval: 1800
```

```
Requested samples: 50 Granted samples: 50
```

```
Maximum table size: 500
```

```
Day: Jan 18 2002
```

```
Time Octets Packets Broadcast Multicast Utilization
```

```
-----
```

```
23:58:30 878128 878 7 1 20.87%
```

```
23:59:00 75898768 91892 932 1723 19.27%
```

```
23:59:30 171797536 193784 1817 3289 19.82%
```

```
Day: Jan 19 2002
```

Time Octets Packets Broadcast Multicast Utilization

00:00:00 287696304 275686 2789 5878 20.17%

00:00:30 303595962 357568 3289 7287 19.98%

Defining Device Events

The **RMON Events Control** page allows network managers to view RMON events. The **RMON Events** table can be opened from the **RMON Events Control** page. To open the **RMON Events Control** page:

- 1 Click **Statistics/RMON > RMON > Events** in the Tree View. The **RMON Events Control** page opens.

The screenshot shows the Dell OpenManage Switch Administrator interface. The top navigation bar includes 'Support', 'Help', 'About', and 'Log Out'. The Dell logo is on the left, and 'PowerConnect 3324' is on the right. The main content area is titled 'RMON Events Control' and contains the following fields and buttons:

- Print** and **Refresh** buttons.
- Add** and **Show All** buttons.
- Event Entry**: A dropdown menu.
- Community**: A text input field.
- Description**: A text input field.
- Type**: A dropdown menu with 'None' selected.
- Time**: A text input field.
- Owner**: A text input field.
- Remove**: A checkbox.
- Apply Changes**: A button.

RMON Events Control Page

The **RMON Events Control** page contains the following fields:

- 1 **Event Entry**—Indicates the event.
- 1 **Community**—Specifies the SNMP community to which the event belongs.
- 1 **Description**—Provides a user-defined event description.
- 1 **Type**—Describes the event type. The possible field values are:

- o **Log**—Indicates the event type is a log entry.
 - o **Trap**—Indicates the event type is a trap.
 - o **Log and Trap**—Indicates the event type is both a log entry and a trap.
- 1 **Time**— Indicates the time at which the event occurred.
 - 1 **Owner**—Indicates the device or user that defined the event.
 - 1 **Remove**—Removes the event from the **Events Table**.
 - o **Checked**—Removes the event from the **Events Table**.
 - o **Unchecked**—Maintains the event from the **Events Table**.

Adding a RMON Event:

1. Open the **RMON Events Control** page.
2. Click **Add**. The **Add New RMON Event** page opens.

Add an Event Entry

Event Entry

Community

Description

Type

Owner

[Apply Changes](#)

Add New RMON Event

3. Define the **New Event Index**, **Community**, **Description**, **Type**, and **Owner** fields.
4. Click **Apply Changes**. The **Event Table** entry is added, and the device is updated.

Modifying a RMON Event:

1. Open the **RMON Events Control** page.
2. Select an **Event Table** entry in the **Event Entry** field.
3. Modify the **Community**, **Description**, **Type**, and/or **Owner** fields.
4. Click **Apply Changes**. The **Event Table** entry is modified, and the device is updated.

Displaying the RMON Event Table:

1. Open the **RMON Events Control** page.
2. Click **Show All**. The **Event Table** opens.

RMON Events Table

Event Entry	Community	Description	Type	Time	Owner	Remove
1	<input type="text"/>	<input type="text"/>	<input type="text" value="None"/>		<input type="text"/>	<input type="checkbox"/>

[Apply Changes](#)

RMON Events Table

Deleting multiple RMON Event entries:

1. Open the **RMON Events Control** page.

2. Select an **Event Table** entry in the **Event Index** field.
3. Check the **Remove** check box.
4. Click **Apply Changes**. The **Event Table** entry is deleted, and the device is updated.

 **NOTE:** A single **Event** entry can be removed from the **RMON Events** page using the **Remove** check box.

Defining and Displaying RMON Events Control Using the CLI Commands

The following table summarizes the equivalent CLI commands for configuring and displaying fields in the **RMON Events Control** page.

CLI Command	Description
<code>rmon event index type [community text] [description text] [owner name]</code>	Configures a RMON event.
<code>show rmon events</code>	Displays the RMON event table.

The following is an example of the CLI commands:

```
Console (config)# rmon event 10 log
```

```
Config (config)# exit
```

```
Console# show rmon events
```

```
Index Description Type Community Owner Last time sent
```

```
-----
```

```
1 Errors Log CLI Jan 18 2002 23:58:17
```

```
2 High Broadcast Log-Trap device Manager Jan 18 2002 23:59:48
```

Viewing the Events Log

The **RMON Events Log** page contains a list the RMON Events. To open the **RMON Events Log**:

1. Click **Statistics/RMON > RMON > Events** in the Tree View. The **RMON Events Log** page opens.

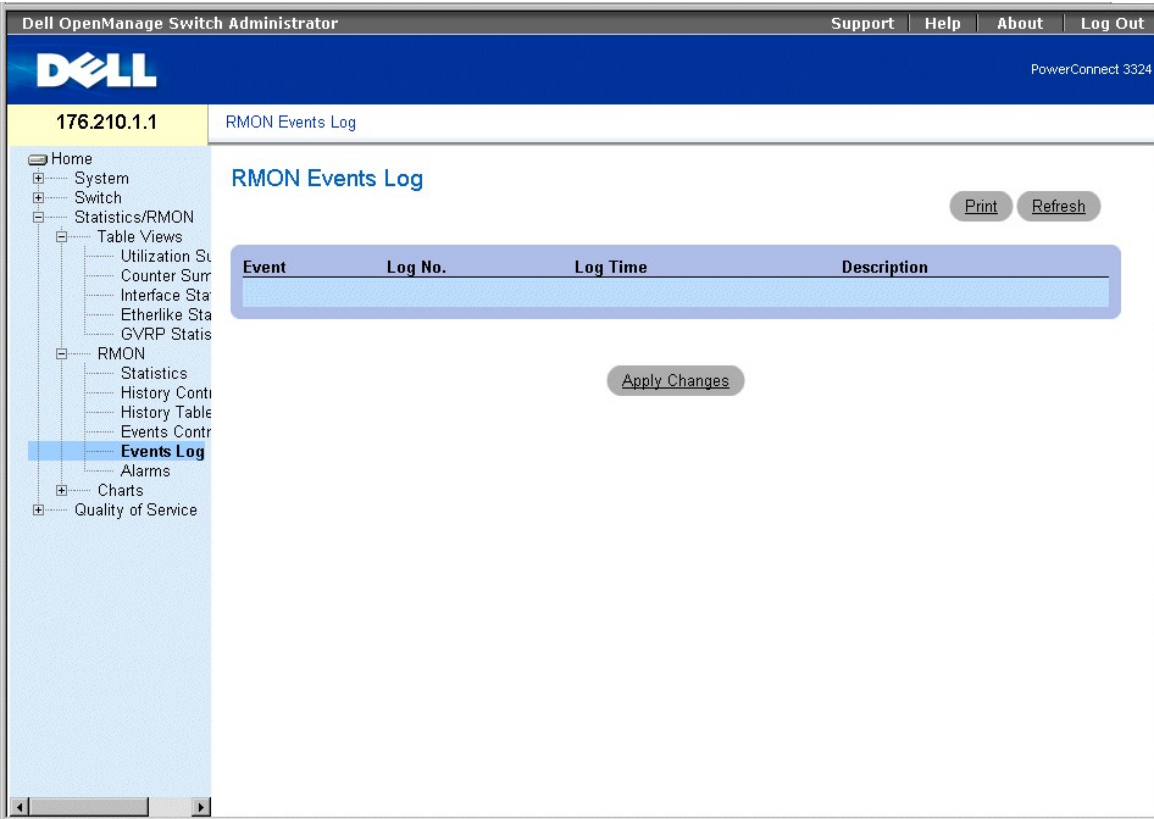

RMON Events Log Page

The **RMON Events Log** page contains the following fields:

- 1 **Event**—Identifies the **RMON Event Log** entry number.
- 1 **Log No.**— Indicates the log number.
- 1 **Log Time**—Specifies the time at which the log entry was entered.
- 1 **Description**—Describes the log entry.

Viewing RMON Events Log Using the CLI Commands

The following table summarizes the equivalent CLI commands for viewing fields displayed in the **RMON Events Log** page.

CLI Command	Description
<code>rmon table-size log <i>entries</i></code>	Configures maximum number of log table entries.
<code>show rmon log [<i>event</i>]</code>	Displays the RMON logging table.

The following is an example of the CLI commands:

```
Console (config)# rmon table-size log 500
```

```
Console# show rmon log
```

Maximum table size: 500

Event Description Time

1 Errors Jan 18 2002 23:48:19

1 Errors Jan 18 2002 23:58:17

2 High Broadcast Jan 18 2002 23:59:48

Console# show rmon log

Maximum table size: 500 (800 after reset)

Event Description Time

1 Errors Jan 18 2002 23:48:19

1 Errors Jan 18 2002 23:58:17

2 High Broadcast Jan 18 2002 23:59:48

Defining Device Alarms

The **RMON Alarm** page allows network administrators to set network alarms. Network alarms occur when a network problem is detected. Rising and falling thresholds generate alarms. To open the **RMON Alarm** page:

- 1 Click **Statistics/RMON > RMON > Alarms** in the Tree View. The **RMON Alarm** page opens.

Dell OpenManage Switch Administrator Support Help About Log Out

PowerConnect 3324

176.210.1.1 RMON Alarms

- Home
- System
- Switch
- Statistics/RMON
 - Table Views
 - Utilization St
 - Counter Surr
 - Interface Sta
 - Etherlike Sta
 - GVRP Statis
 - RMON
 - Statistics
 - History Cont
 - History Table
 - Events Contr
 - Events Log
 - Alarms**
 - Charts
 - Quality of Service

RMON Alarms

Alarm Entry	<input type="text"/>
Counter Name	<input type="text"/>
Counter Value	<input type="text"/>
Sample Type	<input type="text" value="Absolute"/>
Rising Threshold	<input type="text"/>
Rising Event	<input type="text"/>
Falling Threshold	<input type="text"/>
Falling Event	<input type="text"/>
Startup Alarm	<input type="text" value="Rising Alarm"/>
Interval (Sec)	<input type="text"/>
Owner	<input type="text"/>

RMON Alarm Page

The RMON Alarm page contains the following fields:

- 1 **Alarm Entry**—Indicates a specific alarm.
- 1 **Counter Name**—Indicates the selected RMON counter.
- 1 **Counter Value**—Indicates the value of the RMON counter.
- 1 **Sample Type**—Specifies the sampling method for the selected variable and compares the value against the thresholds. The possible field values are:
 - o **Delta**—Subtracts the last sampled value from the current value. The difference in the values is compared to the threshold.
 - o **Absolute**—Compares the values directly with the thresholds at the end of the sampling interval.
- 1 **Rising Threshold**—The rising counter value that triggers the rising threshold alarm.
- 1 **Rising/Falling Event**—The mechanism that reports the alarms: LOGged or TRAPed or a combination of both. When LOG is selected, there is no saving mechanism either in the device or in the management system. However, if the device is not being reset, it remains in the device LOG table. If TRAP is selected, a TRAP via SNMP is generated and reported via the TRAP's general mechanism. The TRAP can be saved using the same mechanism.
- 1 **Falling Threshold**—The falling counter value that triggers the falling threshold alarm.

NOTE: The Rising and Falling thresholds are graphically presented on top of the graph bars. Each monitored variable has a designated color.

- 1 **Startup Alarm**—The trigger that activates the alarm. Rising is defined by crossing the threshold from a low value threshold to a higher value threshold. The possible field values are:
 - o **Rising Alarm**
 - o **Falling Alarm**
 - o **Rising and Falling Alarm**
- 1 **Interval**—Indicates the alarm interval time.
- 1 **Owner**—Indicates the device or user that defined the alarm.
- 1 **Remove**—Removes an RMON Alarm.
 - o **Check**—Removes an **Alarm Table** entry.
 - o **Unchecked**—Maintains an **Alarm Table** entry.

Adding an Alarm Table entry:

1. Open the **RMON Alarm** page.
2. Click **Add**. The **New Alarm Entry** page opens.

Add An Alarm Entry

Attribute	Value
Alarm Entry	
Counter Name	<input type="text"/>
Sample Type	Absolute <input type="text"/>
Rising Threshold	<input type="text"/>
Rising Event	<input type="text"/>
Falling Threshold	<input type="text"/>
Falling Event	<input type="text"/>
Startup Alarm	Rising Alarm <input type="text"/>
Interval	<input type="text"/> (Sec)
Owner	<input type="text"/>

New Alarm Entry

3. Define the **New Alarm Index**, **Sample Variable**, **Sample Type**, **Rising Threshold**, **Rising Event**, **Falling Threshold**, **Falling Event**, **Startup Alarm**, **Interval**, and **Owner** fields.
4. Click **Apply Changes**. The RMON alarm is added, and the device is updated.

Modifying an Alarm Table entry:

1. Open the **RMON Alarm** page.
2. Select an **RMON Alarm Table** entry in the **Alarm Entry** drop-down box.
3. Modify the **Sample Type**, **Rising Threshold**, **Rising Event**, **Falling Threshold**, **Falling Event**, **Startup Alarm**, **Interval**, and/or **Owner** fields.
4. Click **Apply Changes**. The **RMON Alarm Table** entry is modified, and the device is updated.

Displaying the Alarm Table:

1. Open the **RMON Alarm Table**.
2. Click **Show All**. The **RMON Alarm Table** opens.

Alarm Entry	Counter Name	Counter Value	Sample Type	Rising Threshold	Rising Event	Falling Threshold	Falling Event	Startup Alarm	Interval (Sec)	Owner	Remove
1			Absolute <input type="text"/>	<input type="text"/>	<input type="text"/>	<input type="text"/>	<input type="text"/>	Rising Alarm <input type="text"/>	<input type="text"/>		<input type="checkbox"/>

RMON Alarm Table

Deleting an Alarm Table entry:

1. Open the **RMON Alarm** page.
2. Select an **RMON Alarm** in the **Alarm Entry** drop-down box.
3. Check the **Remove** check box.
4. Click **Apply Changes**. The **RMON Alarm Table** entry is deleted, and the device is updated.

Defining and Displaying Device Alarms Using the CLI Commands

The following table summarizes the equivalent CLI commands for configuring and displaying fields in the **RMON Alarm** page.

CLI Command	Description
<code>rmon alarm index variable interval rthreshold fthreshold revent fevent [type type] [startup direction] [owner name]</code>	Configures alarm conditions.
<code>show rmon alarm-table</code>	Displays the alarm summary table.
<code>show rmon alarm number</code>	Displays alarm configurations.

The following is an example of the CLI command:

```
Console (config)# rmon alarm 1.3.6.1.2.1.2.2.1.10 1000000 10 20
```

```
Console (config)# exit
```

```
Console# show rmon alarm-table
```

```
Index OID Owner
```

```
-----
```

```
1 1.3.6.1.2.1.2.2.1.10.1 CLI
```

```
2 1.3.6.1.2.1.2.2.1.10.1 Manager
```

```
3 1.3.6.1.2.1.2.2.1.10.9 CLI
```

```
Console# show rmon alarm 1
```

```
Alarm 1
```

```
-----
```

```
OID: 1.3.6.1.2.1.2.2.1.10.1
```

```
Last sample Value: 878128
```

```
Interval: 30
```

```
Sample Type: delta
```

```
Startup Alarm: rising
```

```
Rising Threshold: 8700000
```

Falling Threshold: 78

Rising Event: 1

Falling Event: 1

Owner: CLI

Viewing Charts

The **Charts** page contains links for displaying statistics in a chart form. To open the **Charts** page:

- 1 Click **Statistics > Charts** in the Tree View. The **Charts** page opens.

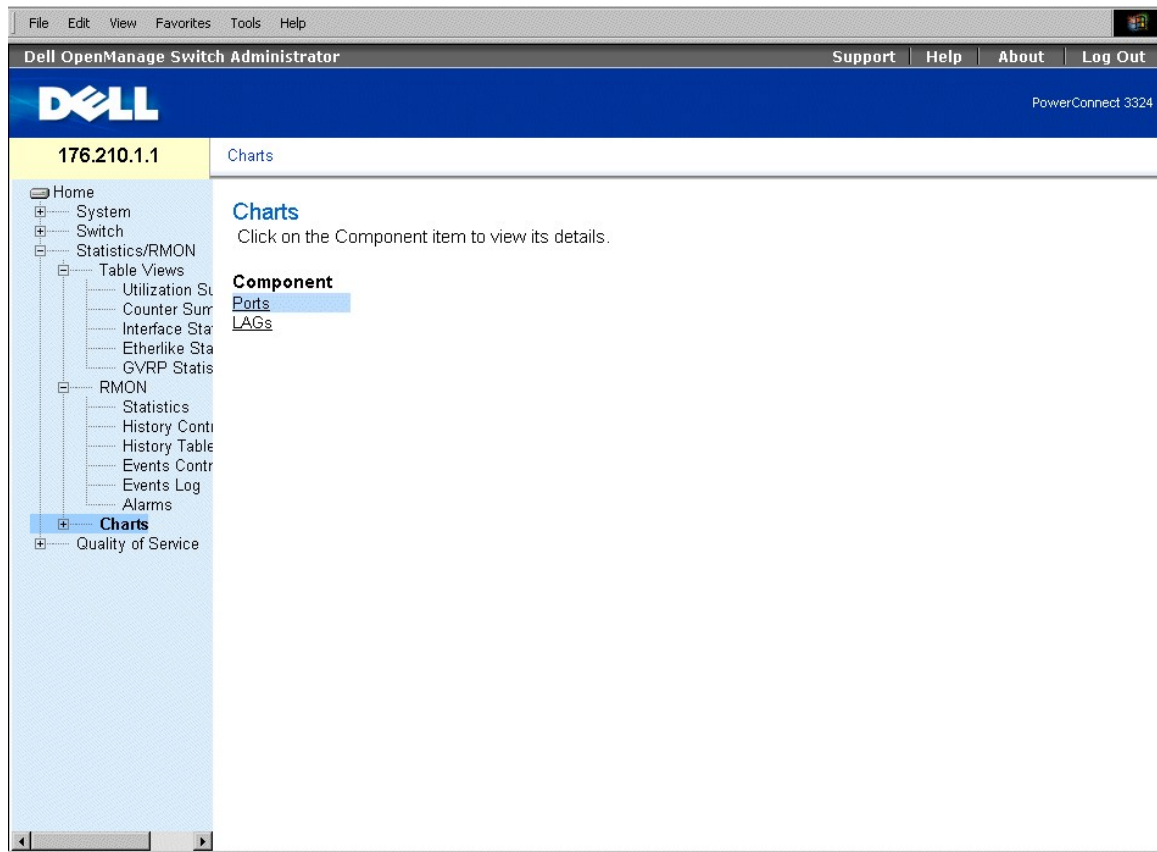

Charts Page

The **Charts** page contains the following links:

- 1 [Viewing Port Statistics](#)
- 1 [Viewing LAG Statistics](#)

Viewing Port Statistics

The **Ports** page displays statistics in a chart form for a selected port. To open the Port **Statistics** page:

1. Click **Statistics > Charts > Ports** in the Tree View. The Port **Statistics** page opens.

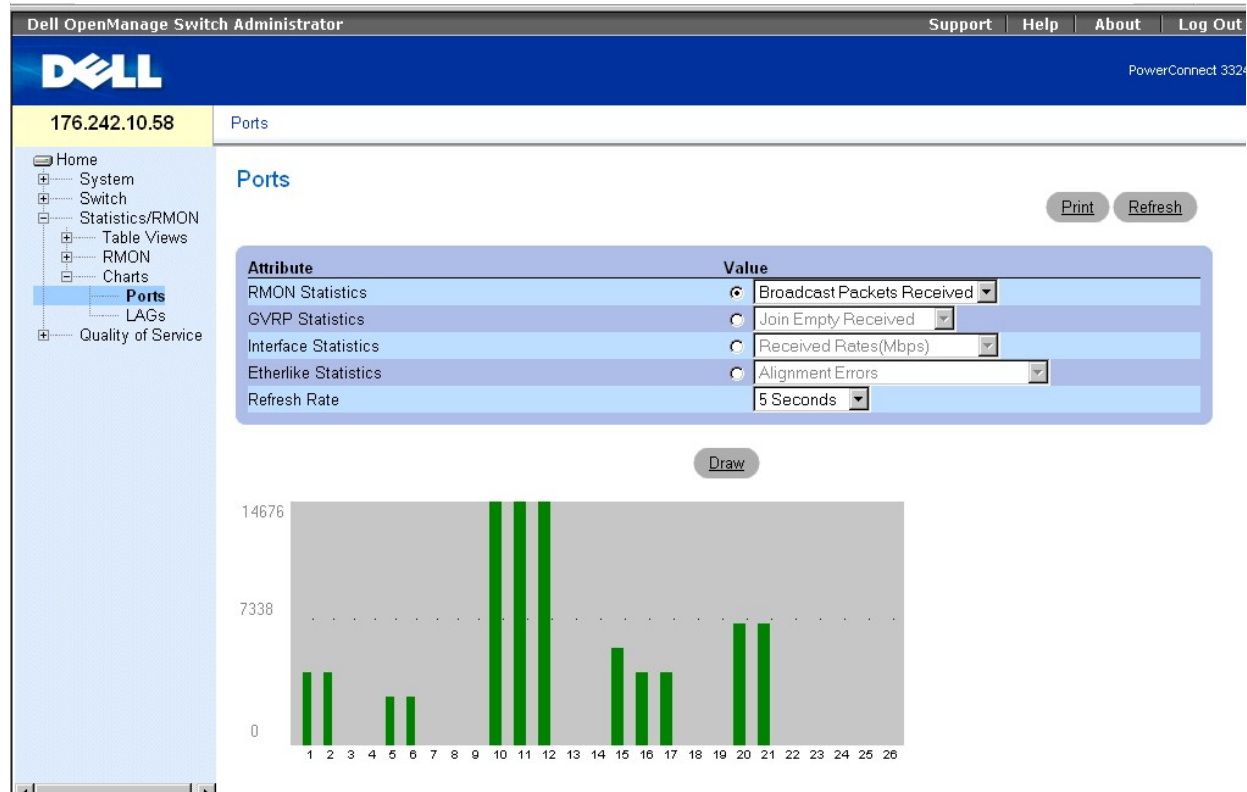

Port Statistics Page

The **Port Statistics** page contains the following fields:

1. **Interface Statistics**—Provides interface statistics for the selected unit.
1. **Etherlike Statistics**—Provides Etherlike statistics for the selected unit.
1. **RMON Statistics**—Provides RMON statistics for the selected unit.
1. **GVRP Statistics**—Provides GVRP statistics for the selected unit.
1. **Refresh Rate**—Specifies the amount of time that passes before the device is refreshed. The possible field values are:
 - o **15 Sec**—Indicates that the port statistics are refreshed every 15 seconds.
 - o **30 Sec**—Indicates that the port statistics are refreshed every 30 seconds.
 - o **60 Sec**—Indicates that the port statistics are refreshed every 60 seconds.
 - o **No Refresh**—Indicates that the port statistics are not automatically refreshed.

Displaying Port Specific Statistics

1. Open the Port **Statistics** page.
2. Select the statistics category and port.
3. Click **Draw**. The statistics for the selected interface is displayed.

Viewing Port Statistics Using the CLI Commands

The following table summarizes the equivalent CLI commands for viewing fields displayed on the Port **Statistics** page.

CLI Command	Description
<code>clear counters [ethernet <i>interface</i> port-channel <i>port-channel-number</i>]</code>	Clears statistics on an interface.
<code>show rmon statistics [ethernet <i>interface</i> port-channel <i>port-channel-number</i>]</code>	Displays RMON ethernet Statistics.
<code>clear gvrp statistics [ethernet <i>interface</i> port-channel <i>port-channel-number</i>]</code>	Clears all the GVRP statistics information.
<code>show gvrp statistics [ethernet <i>interface</i> port-channel <i>port-channel-number</i>]</code>	Displays GVRP statistics.
<code>show gvrp error-statistics [ethernet <i>interface</i> port-channel <i>port-channel-number</i>]</code>	Displays GVRP error statistics.

The following is an example of the CLI commands:

```
Console# clear counters ethernet 1/e1

Console# show rmon statistics ethernet 1/e1

Port 1/e1

Dropped: 8

Octets: 878128 Packets: 978

Broadcast: 7 Multicast: 1

CRC Align Errors: 0 Collisions: 0

Undersize Pkts: 0 Oversize Pkts: 0

Fragments: 0 Jabbers: 0

64 Octets: 98 65 to 127 Octets: 0

128 to 255 Octets: 0 256 to 511 Octets: 0

512 to 1023 Octets: 491 1024 to 1518 Octets: 389

Console # configure

Console (config)# clear gvrp statistics ethernet 1/e8

Console (config)# exit

Console# show gvrp statistics
```

GVRP statistics:

Legend:

rJE : Join Empty Received rJIn : Join In Received

rEmp : Empty Received rLIn : Leave In Received

rLE : Leave Empty Received rLA : Leave All Received

sJE : Join Empty Sent sJIn : Join In Sent

sEmp : Empty Sent sLIn : Leave In Sent

sLE : Leave Empty Sent sLA : Leave All Sent

Port rJE rJIn rEmp rLIn rLE rLA sJE sJIn sEmp sLIn sLE sLA

1/e1 0 0 0 0 0 0 0 0 0 0 0 0

1/e2 0 0 0 0 0 0 0 0 0 0 0 0

1/e3 0 0 0 0 0 0 0 0 0 0 0 0

1/e4 0 0 0 0 0 0 0 0 0 0 0 0

1/e5 0 0 0 0 0 0 0 0 0 0 0 0

1/e6 0 0 0 0 0 0 0 0 0 0 0 0

1/e7 0 0 0 0 0 0 0 0 0 0 0 0

1/e8 0 0 0 0 0 0 0 0 0 0 0 0

Console# show gvrp error-statistics

GVRP error statistics:

Legend:

INVPROT : Invalid Protocol Id INVPLEN : Invalid PDU Length

INVATYP : Invalid Attribute Type INVALEN : Invalid Attribute Length

INVAVAL : Invalid Attribute Value INVEVENT : Invalid Event

Port INVPROT INVATYP INVAVAL INVPLEN INVALEN INVEVENT

1/e1 0 0 0 0 0 0

1/e2 0 0 0 0 0 0

1/e3 0 0 0 0 0 0

1/e4 0 0 0 0 0 0

1/e5 0 0 0 0 0 0

1/e6 0 0 0 0 0 0

1/e7 0 0 0 0 0 0

1/e8 0 0 0 0 0 0

Viewing LAG Statistics

The **LAG Statistics** page displays statistics in a chart form for port elements. To open the **LAG Statistics** page:

- 1 Click **Statistics > Charts > LAGs** in the Tree View. The **LAG Statistics** page opens.

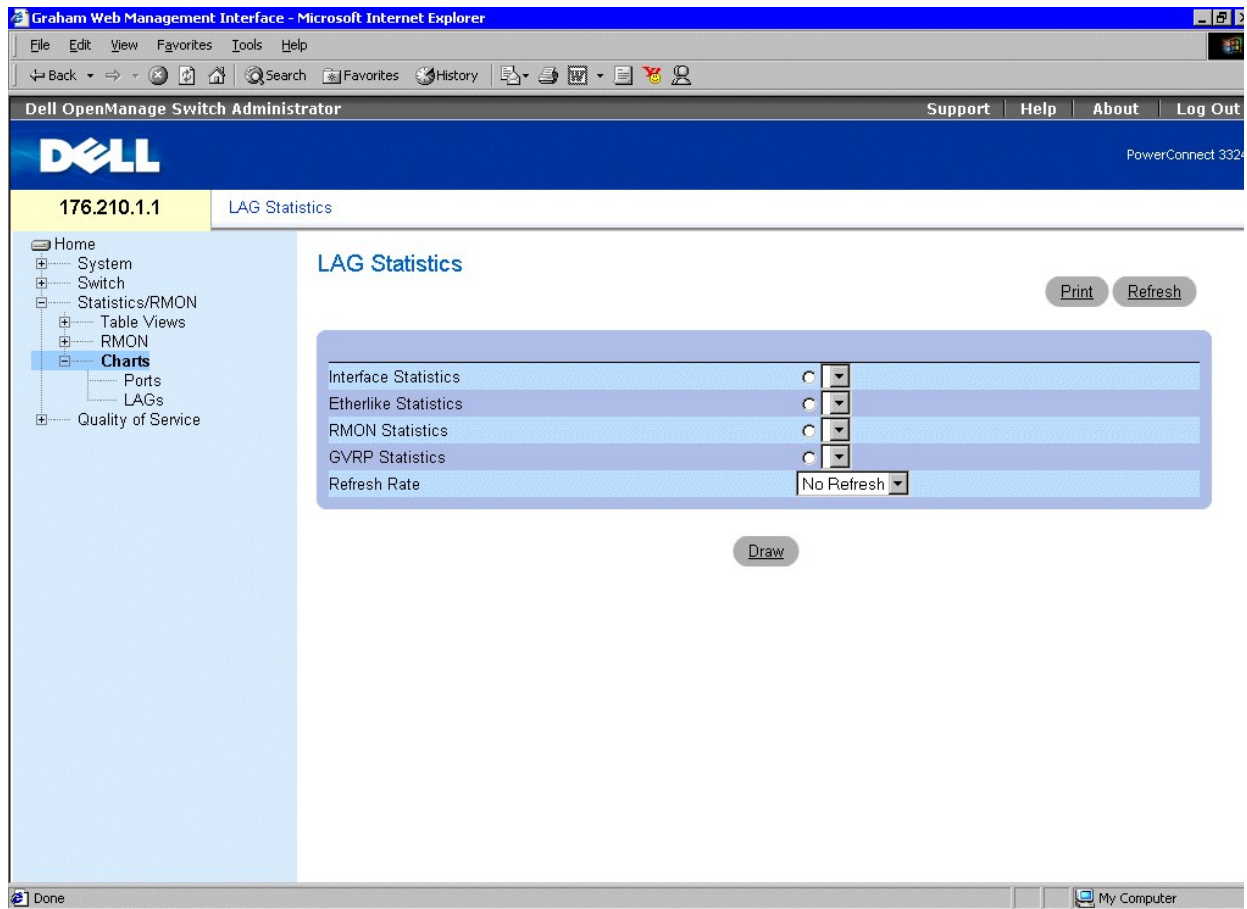

LAG Statistics Page

The **LAG Statistics** page contains the following fields:

- 1 **Interface Statistics**—Provides interface statistics for trunks.
- 1 **Etherlike Statistics**—Provides Etherlike statistics for trunks.
- 1 **RMON Statistics**—Provides RMON statistics for trunks.
- 1 **GVRP Statistics**—Provides GVRP statistics for trunks.
- 1 **Refresh Rate**—Specifies the amount of time that passes before the device is refreshed. The possible field values are:
 - o **15 Sec**—Indicates that the LAG statistics are refreshed every 15 seconds.
 - o **30 Sec**—Indicates that the LAG statistics are refreshed every 30 seconds.
 - o **60 Sec**—Indicates that the LAG statistics are refreshed every 60 seconds.
 - o **No Refresh**—Indicates that the LAG statistics are not refreshed.

Displaying Port Specific Statistics:

1. Open the **Port Statistics** page.
2. Select an interface type.
3. Click **Draw**. The statistics for the selected interface is displayed.

Viewing LAG Statistics Using the CLI Commands

The following table contains the CLI commands for viewing LAG statistics.

CLI Command	Description
<code>show interfaces counters [ethernet <i>interface</i> port-channel <i>port-channel-number</i>]</code>	Displays statistics for a physical interface.

The following is an example of the CLI commands:

```

Console# show interfaces counters

Port InOctets InUcastPkts InMcastPkts InBcastPkts
-----
1/e1 183892 1289 987 8

2/e1 0 0 0 0

3/e1 123899 1788 373 19

Port OutOctets OutUcastPkts OutMcastPkts OutBcastPkts
-----
1/e1 9188 9 8 0

2/e1 0 0 0 0

3/e1 8789 27 8 0

Ch InOctets InUcastPkts InMcastPkts InBcastPkts
-----
1 27889 928 0 78

Ch OutOctets OutUcastPkts OutMcastPkts OutBcastPkts
-----
1 23739 882 0 122

```

Console# show interfaces counters ethernet 1/e1

Port InOctets InUcastPkts InMcastPkts InBcastPkts

1/e1 183892 1289 987 8

Port OutOctets OutUcastPkts OutMcastPkts OutBcastPkts

1/e1 9188 9 8 0

Alignment Errors: 17

FCS Errors: 8

Single Collision Frames: 0

Multiple Collision Frames: 0

SQE Test Errors: 0

Deferred Transmissions: 0

Late Collisions: 0

Excessive Collisions: 0

Internal MAC Tx Errors: 0

Carrier Sense Errors: 0

Oversize Packets: 0

Internal MAC Rx Errors: 0

Symbol Errors: 0

Received Pause Frames: 0

Transmitted Pause Frames: 0

[Back to Contents Page](#)

[Back to Contents Page](#)

Dell™ PowerConnect™ 3324/3348 User's Guide

• [Notes, Notices, and Cautions](#)

Model PowerConnect 3324/3348

Notes, Notices, and Cautions



NOTE: Notes indicate important information that helps you make better use of your device.



NOTICE: Notices indicate either potential damage to hardware or loss of data and tells you how to avoid the problem.



CAUTION: Caution indicates a potential for property damage, personal injury, or death.

Information in this document is subject to change without notice.
© 2003 Dell Inc. All rights reserved.

Reproduction in any manner whatsoever without the written permission of Dell Inc. is strictly forbidden.

Trademarks used in this text: *Dell*, the *DELL* logo, *PowerConnect*, *Dell OpenManage*, *PowerEdge*, *Inspiron*, *Dell Precision*, *Dimension*, *OptiPlex*, *Axim*, *PowerVault*, *PowerApp*, *DellNet*, and *Latitude* are trademarks of Dell Inc.; *Microsoft* and *Windows* are registered trademarks of Microsoft Corporation.

Other trademarks and trade names may be used in this document to refer to either the entities claiming the marks and names or their products. Dell Inc. disclaims any proprietary interest in trademarks and trade names other than its own.

November 2003 Rev. A01

[Back to Contents Page](#)